

# pH 3110

pH METER



a xylem brand

**Copyright**

© 2017 Xylem Analytics Germany GmbH  
Printed in Germany.

## pH 3110 - Contents

<b>1</b>	<b>Overview</b>	<b>5</b>
1.1	Keypad	6
1.2	Display	7
1.3	Socket field	8
<b>2</b>	<b>Safety</b>	<b>9</b>
2.1	Authorized use	10
2.2	General safety instructions	10
<b>3</b>	<b>Commissioning</b>	<b>13</b>
3.1	Scope of delivery	13
3.2	Initial commissioning	13
3.2.1	Inserting the batteries	13
3.2.2	Switching on the meter	14
<b>4</b>	<b>Operation</b>	<b>15</b>
4.1	General operating principles	15
4.1.1	Operating modes	15
4.1.2	Operation	15
4.2	Measuring	16
4.2.1	Measuring the pH value	17
4.2.2	Measuring the ORP	18
4.3	Calibration	19
4.3.1	Calibration interval ( <i>Int.C</i> )	21
4.3.2	Automatic calibration (AutoCal)	22
4.3.3	Conventional calibration (ConCal)	24
4.4	Downloading calibration data	27
4.5	Settings	28
4.5.1	System settings	29
4.5.2	Measurement settings	30
4.6	Reset	34
4.6.1	Resetting calibration values	34
4.6.2	Resetting all meter settings	35
<b>5</b>	<b>Maintenance, cleaning, disposal</b>	<b>37</b>
5.1	Maintenance	37
5.1.1	Replacing the batteries	37
5.2	Cleaning	38
5.3	Packing	38

---

5.4	Disposal.....	38
<b>6</b>	<b>What to do if.....</b>	<b>39</b>
<b>7</b>	<b>Technical data.....</b>	<b>43</b>
7.1	General data.....	43
7.2	Measuring ranges, resolution, accuracy.....	44
<b>8</b>	<b>Lists.....</b>	<b>45</b>

# 1 Overview

The compact pH 3110 precision pH meter enables you to perform pH measurements rapidly and reliably. The pH 3110 provides the maximum degree of operating comfort, reliability and measuring certainty for all applications.

The proven calibration procedures and automatic stability control function (AR) support your work with the pH meter.

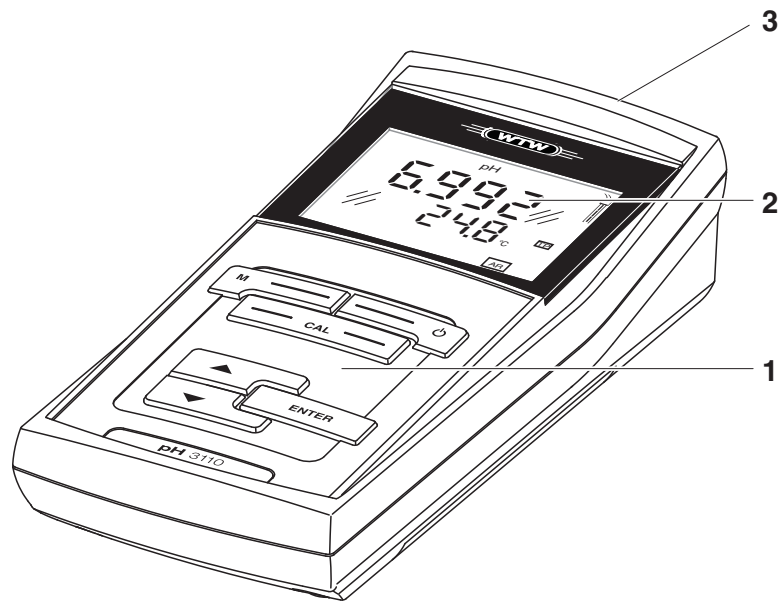



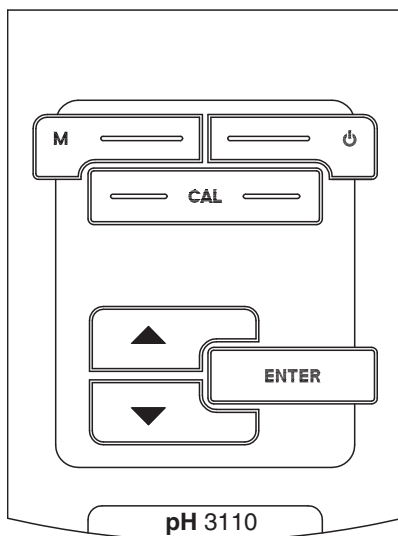

1	Keypad
2	Display
3	Socket field

### 1.1 Keypad

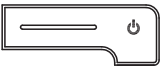
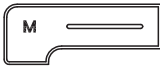

In this operating manual, keys are indicated by brackets <.> . The key symbol (e.g. <ENTER>) generally indicates a short keystroke (under 2 sec) in this operating manual. A long keystroke (approx. 2 sec) is indicated by the underscore behind the key symbol (e.g. <ENTER\_\_>).

	<On/Off>: Switches the meter on/off <On/Off__>: Resets calibration data
	<M>: Selects the measured parameter <M__>: Opens the setting menu for calibration and measurements
	<CAL>: Calls up the calibration procedure <CAL__>: Displays the calibration data
	<>: Increments values, scrolls
	<>: Decrements values, scrolls
	<ENTER>: Confirms entries <ENTER__>: Opens the setting menu for system settings :

### 1.2 Display

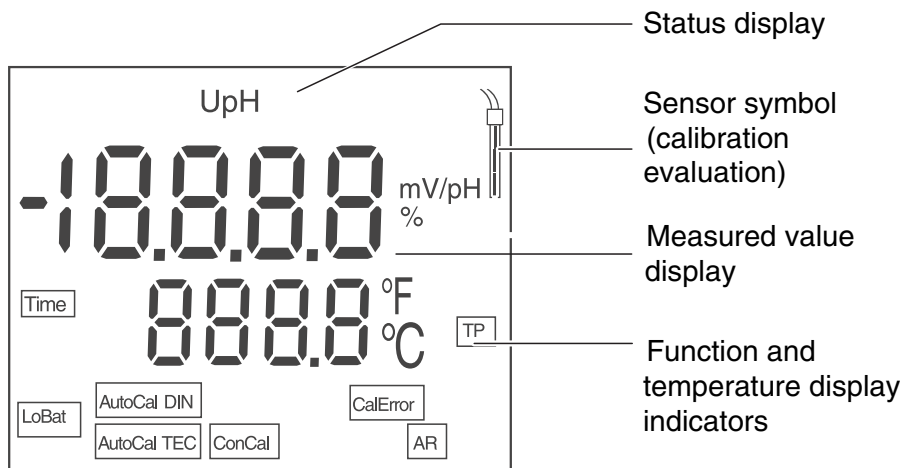

#### Function display indicators

AutoCal TEC	Calibration with automatic buffer recognition (buffer set: Technical buffers )
AutoCal DIN	Calibration with automatic buffer recognition (buffer set: DIN buffers )
ConCal	Calibration with any buffers
CalError	An error occurred during calibration
LoBat	With battery operation: Batteries almost empty
AR	Stability control (AutoRead) is active
TP	Temperature measurement active
TIME	Setting of calibration interval

### 1.3 Socket field

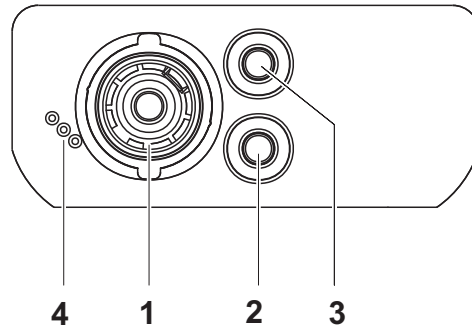

Connectors:

1	pH electrode
2	Reference electrode
3	Temperature sensor
4	Service interface



#### Caution

Only connect sensors to the meter that cannot return any voltages or currents that are not allowed (> SELV and > current circuit with current limiting).

Almost all customary sensors fulfill these conditions.



## 2 Safety

This operating manual contains basic instructions that you must follow during the commissioning, operation and maintenance of the meter. Consequently, all responsible personnel must read this operating manual before working with the meter.

The operating manual must always be available within the vicinity of the meter.

### Target group

The meter was developed for work in the field and in the laboratory. Thus, we assume that, as a result of their professional training and experience, the operators will know the necessary safety precautions to take when handling chemicals.

### Safety instructions

Safety instructions in this operating manual are indicated by the warning symbol (triangle) in the left column. The signal word (e.g. "Caution") indicates the level of danger:



#### Warning

**indicates instructions that must be followed precisely in order to avoid possibly great dangers to personnel.**



#### Caution

**indicates instructions that must be followed precisely in order to avoid the possibility of slight injuries or damage to the meter or the environment.**

### Further notes



#### Note

indicates notes that draw your attention to special features.



#### Note

indicates cross-references to other documents, e.g. operating manuals.

## 2.1 Authorized use

This meter is authorized exclusively for pH and ORP measurements in a laboratory or field environment.

The technical specifications as given in chapter 7 TECHNICAL DATA must be observed. Only the operation and running of the meter according to the instructions given in this operating manual is authorized.

Any other use is considered **unauthorized**.

## 2.2 General safety instructions

This meter is constructed and tested in compliance with the IEC 1010 safety regulations for electronic measuring instruments.

It left the factory in a safe and secure technical condition.

### Function and operational safety

The smooth functioning and operational safety of the meter can only be guaranteed if the generally applicable safety measures and the specific safety instructions in this operating manual are followed during operation.

The smooth functioning and operational safety of the meter can only be guaranteed under the environmental conditions that are specified in chapter 7 TECHNICAL DATA.

If the meter was transported from a cold environment to a warm environment, the formation of condensate can lead to the faulty functioning of the meter. In this event, wait until the temperature of the meter reaches room temperature before putting the meter back into operation.



### Caution

**The meter is only allowed to be opened by authorized personnel.**

**Safe operation**

If safe operation is no longer possible, the meter must be taken out of service and secured against inadvertent operation!

Safe operation is no longer possible if the meter:

- has been damaged in transport
- has been stored under adverse conditions for a lengthy period of time
- is visibly damaged
- no longer operates as described in this manual.

If you are in any doubt, please contact the supplier of the meter.

**Obligations of the purchaser**

The purchaser of this meter must ensure that the following laws and guidelines are observed when using dangerous substances:

- EEC directives for protective labor legislation
- National protective labor legislation
- Safety regulations
- Safety datasheets of the chemical manufacturers.

**Caution**

**In addition to the safety instructions mentioned here, also follow the safety instructions of the sensors used.**

**The operating manuals of the sensors are available on the supplied CD and on the Internet under [www.WTW.com](http://www.WTW.com).**



## 3 Commissioning

### 3.1 Scope of delivery

- Handheld meter, pH 3110
- 4 batteries 1.5 V Mignon type AA
- Short instructions
- CD-ROM with detailed operating manual

### 3.2 Initial commissioning

Perform the following activities:

- Insert the supplied batteries
- Switch on the meter

#### 3.2.1 Inserting the batteries

1	Unscrew the two screws (1) on the underside of the meter.
2	Open the battery compartment (2) on the underside of the meter.

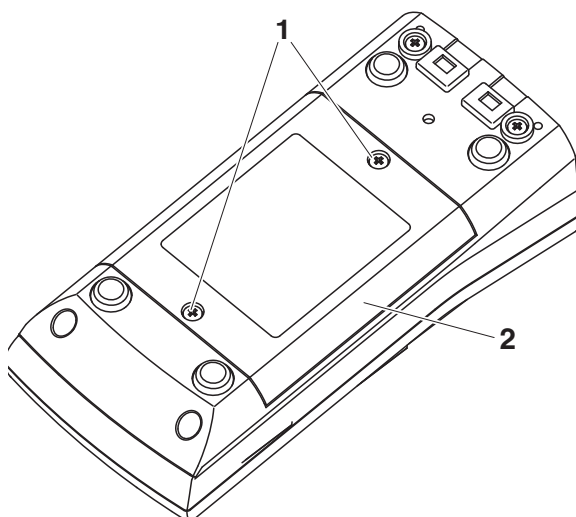

3	Place four batteries (type Mignon AA) in the battery compartment.
---	---

**Note**

Alternatively, you can also use Ni-MH rechargeable batteries (type Mignon AA). In order to charge the batteries, an external charging device is required.

**Caution**

**Make sure that the poles of the batteries are positioned correctly. The  $\pm$  signs on the batteries must correspond to the  $\pm$  signs in the battery compartment.**

- 4 Close the battery compartment (2) and tighten the screws (1).

### 3.2.2 Switching on the meter

- 1 Press the <On/Off> key.  
A display test is briefly displayed.  
Subsequently, the meter switches to the measuring mode (measured value display).

**Note**

The meter has an energy saving feature to avoid unnecessary battery depletion during battery operation. The energy saving feature switches off the meter if no key was pressed during the specified interval (setting the switch-off interval see section 4.5.1).

## 4 Operation

### 4.1 General operating principles

This section contains basic information on the operation of the pH 3110.

#### 4.1.1 Operating modes

The meter has the following operating modes:

- Measurement  
The display indicates the measurement data in the measured value display
- Calibration  
The display guides you through a calibration procedure with calibration information
- Configuration  
The system menu or a sensor menu with submenus, settings and functions is displayed

#### 4.1.2 Operation

**Keys** The meter is operated via keys. The keys can have different functions with long or short keystrokes.

**Functions** Generally, with a short keystroke a function is carried out. A long keystroke opens a setting menu.

In a setting menu, settings are selected with the < >< > keys. A setting is confirmed with **<ENTER>**. With confirming, the setting is finished and the next setting is displayed.

**Representation** In this operating manual, keys are indicated by brackets <..> . The key symbol (e.g. **<ENTER>**) generally indicates a short keystroke (under 2 sec) in this operating manual. A long keystroke (approx. 2 sec) is indicated by the underscore behind the key symbol (e.g. **<ENTER\_\_>**).

## 4.2 Measuring

### Preparatory activities

Perform the following preparatory activities when you want to measure:

1	Connect the pH combination electrode to the meter.
2	Adjust the temperature of the buffer solutions or test solutions, or measure the current temperature, if you measure without a temperature sensor.
3	Calibrate or check the meter with the combination electrode.
4	Select the measured parameter with <M>.



#### Note

Incorrect calibration of pH combination electrodes leads to incorrect measured values. Calibrate regularly before measuring.

### Stability control AutoRead

During the measuring procedure, the stability control function is automatically activated. The stability has a considerable effect on the reproducibility of the measured value.

The Stability control function checks whether the measured values are stable within the monitored time interval.

Measured parameter	Time interval	Stability in the time interval
pH value	15 seconds	$\Delta$ : Better than 0.02 pH
ORP voltage	15 seconds	$\Delta$ : Better than 0.3 mV
Temperature	15 seconds	$\Delta$ : Better than 0.5 °C

The minimum duration until a measured value is assessed as stable is the monitored time interval. The actual duration is mostly longer.

### Temperature sensor

You can measure with or without a temperature sensor. If a temperature sensor is connected, it is indicated on the display by *TP*.



#### Note

The pH meter automatically recognizes the type of the temperature sensor used. Therefore, you can connect combination electrodes with an NTC30 or Pt1000.

The temperature measurement is absolutely essential for a reproducible pH measurement. If the measurement is made without a temperature sensor, proceed as follows:

1	Measure the current temperature using a thermometer.
2	Set the temperature value with < >> >.



**Note**

When calibrating without temperature sensor, also set the current temperature of each buffer solution manually with the <>< > keys.

**4.2.1 Measuring the pH value**

1	Perform the preparatory activities according to section 4.2.
2	Immerse the pH combination electrode in the test sample.
3	Using <M>, scroll as necessary until the measured parameter <i>pH</i> is displayed.
4	Wait for a stable measured value. The AR display indicator flashes as long as the measured value is not yet stable.

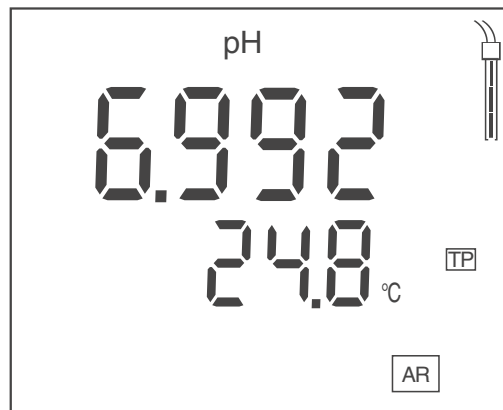

#### 4.2.2 Measuring the ORP

The meter can, in conjunction with an ORP electrode, measure the ORP (mV) of a solution.

1	Perform the preparatory activities according to section 4.2.
2	Immerse the ORP electrode in the test sample.
3	If necessary, call up the measured parameter U with <M>.
4	Wait for a stable measured value. The AR display indicator flashes as long as the measured value is not yet stable.

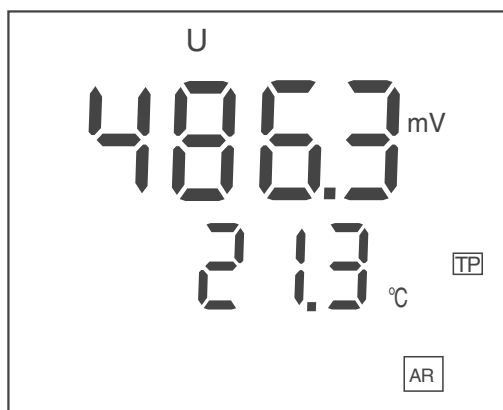
**Note**

ORP electrodes are not calibrated. However, you can check ORP electrodes using a test solution.

### 4.3 Calibration

#### Why calibrate?

pH combination electrodes age. This changes the zero point (asymmetry) and slope of the pH combination electrode. As a result, an inexact measured value is displayed. Calibration determines the current values of the zero point and slope of the combination electrode and stores them in the measuring instrument. Thus, you should calibrate at regular intervals.

#### When do you have to calibrate?

- After connecting another combination electrode
- When the sensor symbol flashes on the display:
  - e.g. after the calibration interval has expired

#### AutoCal

is adapted to the permanently programmed buffer solutions as a fully automatic single-point, two-point or three-point calibration. The buffer solutions are automatically recognized by the meter.

The following buffer sets are suitable:

- Technical buffers (AutoCal TEC)
- DIN buffers (AutoCal DIN)

#### Calibration points

Calibration can be performed using one, two or three buffer solutions in any order (single-point, two-point or three-point calibration). The meter determines the following values and calculates the calibration line as follows:

	Determined values	Displayed calibration data
<b>1-point</b>	ASY	<ul style="list-style-type: none"> <li>● Zero point = ASY</li> <li>● Slope = Nernst slope (-59.16 mV/pH at 25 °C)</li> </ul>
<b>2-point</b> <b>3-point</b>	ASY SLO	<ul style="list-style-type: none"> <li>● Zero point = ASY</li> <li>● Slope = SLO</li> </ul>



#### Note

You can display the slope in the units, mV/pH or %.  
You can display the zero point in the units, mV or pH.

#### ConCal

This function is a conventional two-point calibration using two buffer solutions (pH 7.0 ± 0.5 and any other buffer solution) or a single-point calibration using any buffer solution and is used as a high-speed method.

#### Stability control AutoRead

The calibration procedure automatically activates the stability control function. The current measurement with stability control can be terminated at any time (accepting the current value) by pressing **<ENTER>**.

**Calibration record**





When finishing a calibration, the new calibration values are first displayed as an informative message and stored.

**Displaying the calibration data**

You can display the data of the last calibration (see section 4.4).

**Calibration evaluation**

After calibrating, the meter automatically evaluates the calibration. The zero point and slope are evaluated separately. The worse evaluation of both is taken into account. The evaluation appears on the display as the sensor symbol and in the calibration record.

Sensor symbol	Zero point [mV]	Slope [mV/pH]
	-15 ... +15	-60.5 ... -58
	-20 ... +20	-58 ... -57
	-25 ... +25	-61 ... -60.5 or -57 ... -56
	-30 ... +30	-62 ... -61 or -56 ... -50
Clean the combination electrode according to the electrode operating manual		
<i>CalError</i>	< -30 or > 30	... -62 or ... -50
Eliminate the error according to chapter 6 WHAT TO DO IF...		

**Preparatory activities**

1	Switch on the meter with <On/Off>.
2	Connect the pH combination electrode to the meter.
3	Keep the buffer solutions ready.
4	Adjust the temperature of the solutions and measure the current temperature if the measurement is made without temperature sensor.

- |   |   |
|---|---|
| 5 | Set the buffer set to be used for calibration as necessary. |
|---|---|

#### 4.3.1 Calibration interval (*Int.C*)

The calibration interval reminds you to calibrate regularly. When the adjusted calibration interval (*Int.C*) has expired, the sensor symbol flashes. It is still possible to measure.



#### Setting the calibration interval

##### Note

To ensure the high measuring accuracy of the measuring system, calibrate after the calibration interval has expired.

The calibration interval (*Int.C*) is set to 7 days (*d7*) in the factory. You can change the interval (1 ... 999 days):

- |   |  |
|---|--|
| 1 | Open the menu for measurement settings with <M__>.                 |
| 2 | Confirm all settings with <ENTER> until <i>Int.C</i> is displayed. |

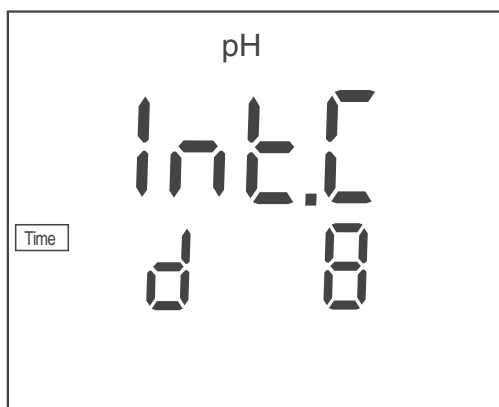

- |   |  |
|---|--|
| 3 | Set the calibration interval with <>> >. |
| 4 | Confirm the setting with <ENTER>.        |

### 4.3.2 Automatic calibration (AutoCal)

For the AutoCal TEC and AutoCal DIN procedures, use one to three buffer solutions of the relevant buffer set (Technical buffers or DIN buffers) in any order.



**Note**

The steps 2 and 6 are not necessary if you use a temperature sensor.

- 1 Press <CAL> repeatedly until the AutoCal TEC or AutoCal DIN function display indicator appears.

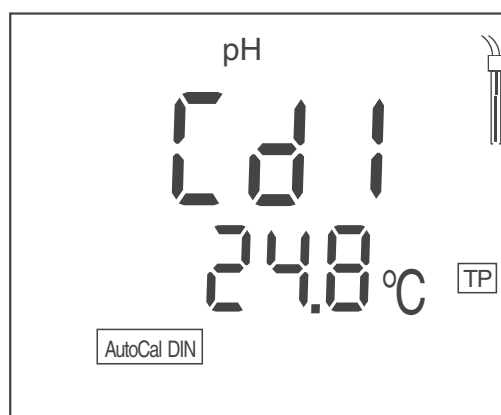
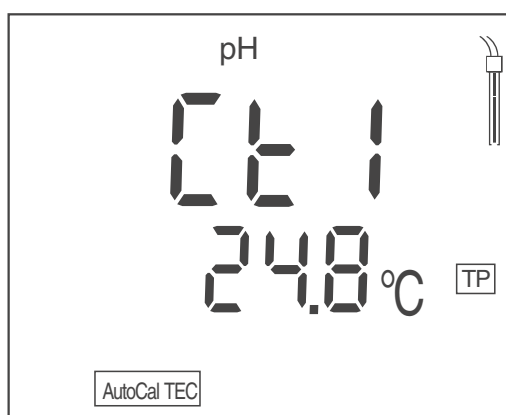

- 2 If necessary, set the temperature of the buffer solution with <>>>.
- 3 Immerse the pH combination electrode in the first buffer solution.
- 4 Start the measurement with <ENTER>. The AR display indicator flashes. The electrode voltage (mV) or the nominal value of the buffer (setting: see section 4.5.2) is displayed. As soon as a stable value is recognized, Ct2 or Cd2 appears.

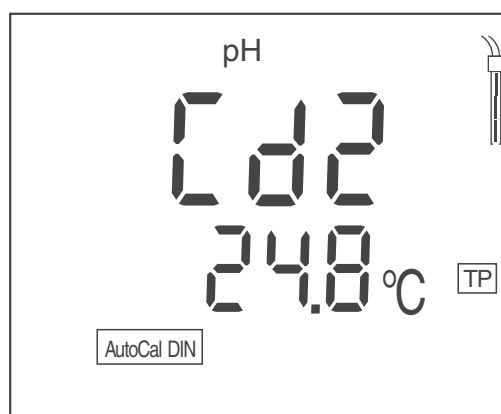
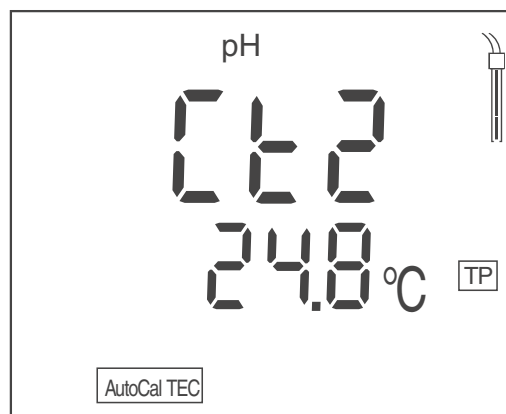



**Note**

Here you can cancel the calibration procedure with **<M>**. This corresponds to a **single-point calibration**. The value of the zero point (ASY) is displayed. Pressing **<ENTER>** displays the value of the slope (SLO).

**Continuing with two-point calibration**

5	Thoroughly rinse the combination electrode with distilled water.
6	If necessary, set the temperature of the second buffer solution with <b>&lt;&gt;&gt;</b> .
7	Immerse the combination electrode in the second buffer solution.
8	Press the <b>&lt;ENTER&gt;</b> key. The AR display indicator flashes. The electrode voltage (mV) or the nominal value of the buffer (setting: see section 4.5.2) is displayed. As soon as a stable value is recognized, Ct3 or Cd3 appears.

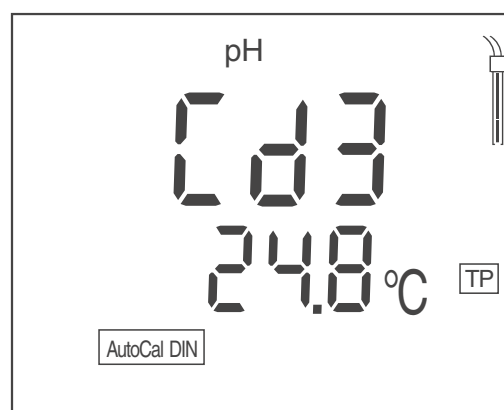
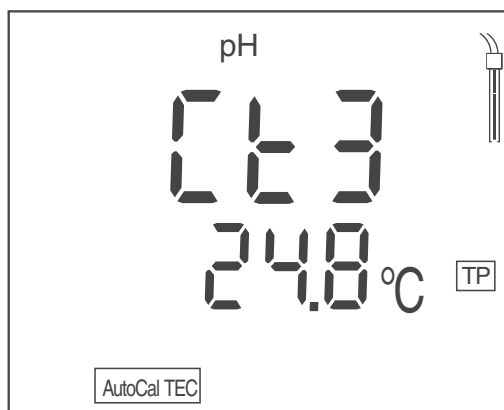

**Note**

Here you can cancel the calibration procedure with **<M>**. This corresponds to a **two-point calibration**. The value of the zero point (ASY) is displayed. Pressing **<ENTER>** displays the value of the slope (SLO).

**Continuing with three-point calibration**

9	Thoroughly rinse the combination electrode with distilled water.
10	If necessary, set the temperature of the third buffer solution with <b>&lt;&gt;&gt;</b> .
11	Immerse the combination electrode in the third buffer solution.

- |    |  |
|----|--|
| 12 | Press the <b>&lt;ENTER&gt;</b> key.<br>The AR display indicator flashes.<br>The electrode voltage (mV) or the nominal value of the buffer (setting: see section 4.5.2) is displayed. The asymmetry is displayed as soon as a stable value is recognized. |
| 13 | Press the <b>&lt;ENTER&gt;</b> key.<br>The value of the slope (mV/pH) appears on the display.  |
| 14 | To return to the measuring mode: Press the <b>&lt;ENTER&gt;</b> key.   |

**Note**

While the zero point (*ASY*) is being displayed, you can change the unit of the zero point with **<><>**.

While the slope (*SLO*) is being displayed, you can change the unit of the slope with **<><>**.

The % display refers to the Nernst slope of 59.2 mV/pH at 25° C (100 x determined slope/Nernst slope).

The unit of zero point and slope can also be changed permanently in the measurement settings (see section 4.5.2).

**4.3.3 Conventional calibration (ConCal)****Single-point calibration**

Use any buffer solution for this rapid method.  
The calibration will be the more exact the nearer the pH value of the buffer solution is to that of the test sample.

**Two-point calibration**

Use two buffer solutions for this procedure:

- pH 7.0 ± 0.5
- any other buffer solution

**Note**

The steps 2 and 8 are not necessary if you use a pH combination electrode with a temperature sensor.

- |   |   |
|---|---|
| 1 | Press the <b>&lt;CAL&gt;</b> key repeatedly until the <i>ASY</i> display indicator and the <i>ConCal</i> function indicator appear. |
|---|---|



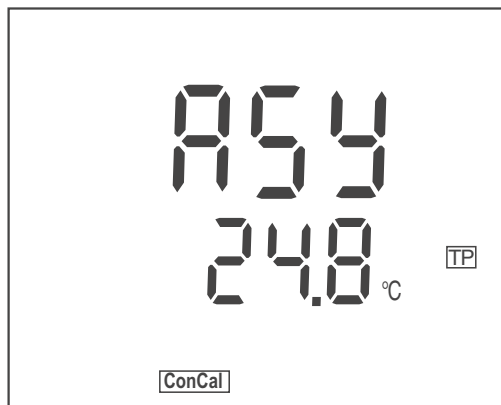

2	If necessary, set the temperature of the first buffer solution with <><>.
3	Immerse the pH combination electrode in the first buffer solution (pH 7.0 ± 0.5 for two-point calibration).
4	Press the <ENTER> key. The measured pH value appears on the display.
5	When the measured value is stable, using <><>, set the measured value to the nominal pH value of the buffer solution (at the current temperature).
6	Press the <ENTER> key. <i>SLO</i> appears on the display.



### Note

Here you can cancel the calibration procedure with <M>. This corresponds to a **single-point calibration**. The value of the zero point (ASY) is displayed. The sensor symbol shows the evaluation of the single-point calibration. Pressing <ENTER> displays the value of the slope (SLO).

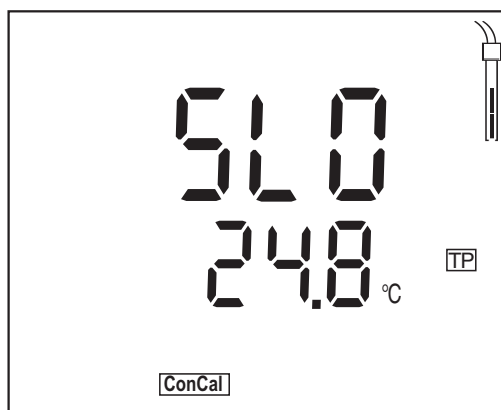

7	To continue the two-point calibration, thoroughly rinse the combination electrode with deionized water.
8	If necessary, set the temperature of the second buffer solution with < >< >.
9	Immerse the combination electrode in the second buffer solution.
10	Press the <ENTER> key. The second pH value appears on the display.
11	When the measured value is stable, using < >< >, set the measured value to the nominal pH value of the buffer solution (at the current temperature).
12	Press the <ENTER> key. The value of the zero point (ASY) is displayed.
13	Press the <ENTER> key. The value of the slope (SLO) is displayed.
14	Press the <ENTER> key. The measuring mode is active.

**Note**

While the zero point (ASY) is being displayed, you can change the unit of the zero point with < >< >.

While the slope (SLO) is being displayed, you can change the unit of the slope with < >< >.

The % display refers to the Nernst slope of 59.2 mV/pH at 25° C (100 x determined slope/Nernst slope).

The units of the zero point and slope can also be changed permanently in the measurement settings (see section 4.5.2).

#### 4.4 Downloading calibration data

You can download calibration data to the display as follows:

- 1 Pressing **<CAL\_\_>** displays the calibration data (asymmetry).

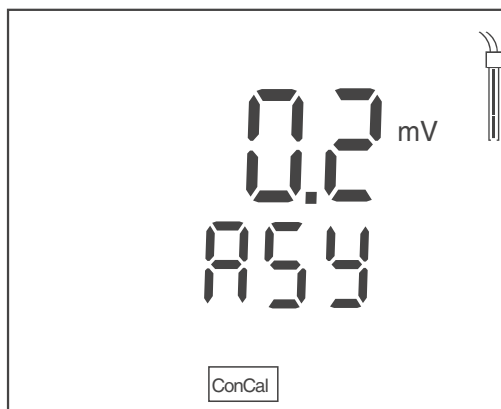
**Note**

While the calibration data is displayed you can press **<>>>** to switch over the unit of the zero point (*ASY*).

- 2 With **<ENTER>** display the slope.

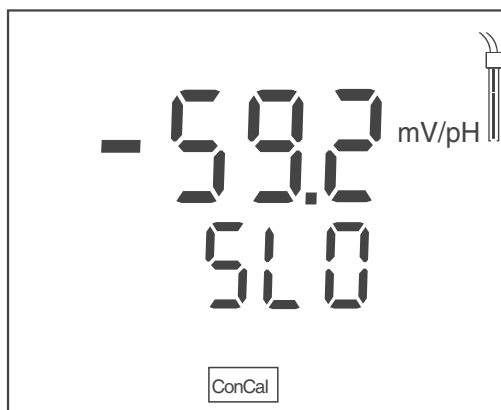
**Note**

While the calibration data is displayed you can press **<>>>** to switch over the unit of the slope (*SLO*).

## 4.5 Settings

You can adapt the meter to your individual requirements. The settings are done in the following menus:

- System settings (<ENTER\_\_>)
  - Switch-off interval (*t.Off*)
- Measurement settings (<M\_\_>)
  - Display of the buffer during calibration (pH nominal value or measured voltage value in mV)
  - Unit of the value for the slope (*mV/pH* or %)
  - Unit of the value for the zero point (*mV, pH*)
  - Measured value resolution, pH (*0.000 / 0.00 / 0.0*)
  - Measured value resolution, U (*0.0 / 0*)
  - Temperature unit (*°C / °F*)
  - Calibration interval (*Int.C [0 ... 999]*)



### Note

You can exit the setting menu at any time by pressing <M>. Settings already modified and confirmed with <ENTER> are stored.

#### 4.5.1 System settings

The default setting is printed in bold.

Switch-off interval ( <i>t.Off</i> )	10, 20, 30, 40, 50 min, <b>1</b> , 2, 3, 4, 5, 10, 15, 20, 24 h
--------------------------------------	--

- 1 Open the menu for system settings with **<ENTER\_\_>**.  
The first system setting is displayed.

Switch-off interval (*t.Off*)

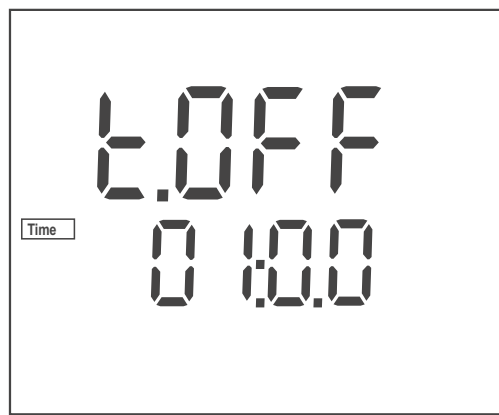

- 2 Set the switch-off interval with **<><>**.
- 3 Confirm with **<ENTER>**.  
The system settings are completed.  
The meter switches to the measuring mode.

### 4.5.2 Measurement settings

These settings apply to calibration and measurement (the default setting is printed in bold).

Display during calibration ( <i>BUFFER</i> )	<b>pH</b> (buffer nominal value), <i>U</i> (combination electrode voltage)
Unit of the value for the slope ( <i>SLO</i> )	<b>mV/pH</b> , %
Unit of the value for the zero point ( <i>ASY</i> )	<b>mV</b> , pH
Measured value resolution, pH	<b>0.000</b> , 0.00, 0.0
Measured value resolution, U	<b>0.0</b> , 0
Temperature unit ( <i>Unit</i> )	<b>°C</b> , °F
Calibration interval ( <i>Int.C</i> )	0 ... <b>7</b> ... 999 d

- 1 With **<M\_\_>** open the menu for measurement and calibration settings.  
The first setting is displayed.

Display during calibration  
(*bUFF*)

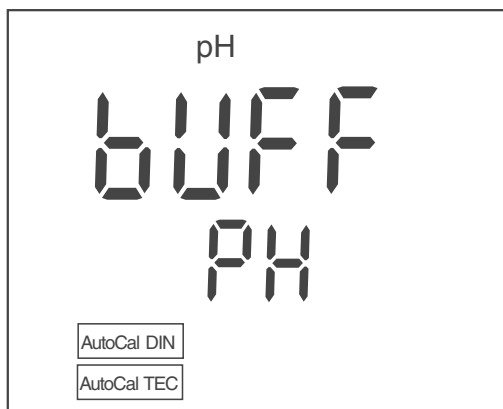

- 2 Using **<>>**, select the *pH* or *U* display during calibration.
- 3 Confirm with **<ENTER>**.  
*SLO*, the unit of the value for the slope (*mV/pH* or %) is displayed.

Unit of the value for the slope  
(SLO)

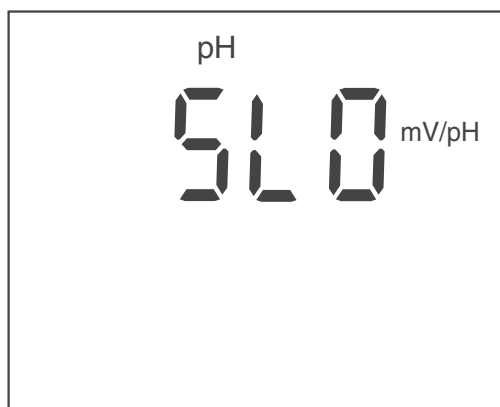

- |   |  |
|---|--|
| 4 | Using <>< >, select the unit for the slope.  |
| 5 | Confirm with <ENTER>. <i>ASY</i> , the unit of the value for the zero point ( <i>mV</i> or <i>pH</i> ) is displayed. |

Unit of the value for the zero point  
(ASY)

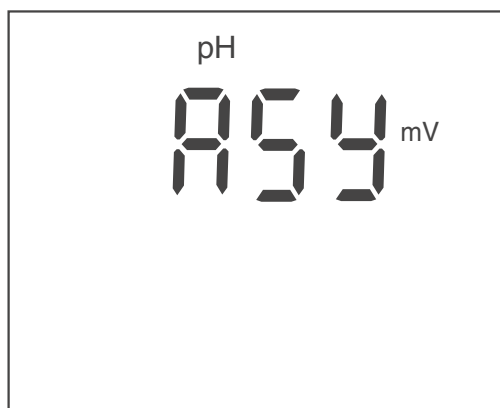

- |   |  |
|---|--|
| 6 | Using <>< >, select the unit for the zero point.   |
| 7 | Confirm with <ENTER>. <i>res</i> , the resolution of the pH display ( <i>0.0</i> , <i>0.00</i> or <i>0.000</i> ) appears on the display. |

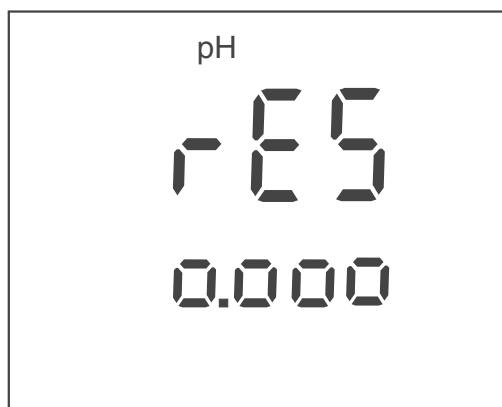
**pH resolution  
(res)**

- |   |   |
|---|---|
| 8 | Select the resolution for the pH display with < > < > >.  |
| 9 | Confirm with <ENTER>. <i>res</i> , the resolution of the voltage display (0.0, 0.00 or 0.000) appears on the display. |

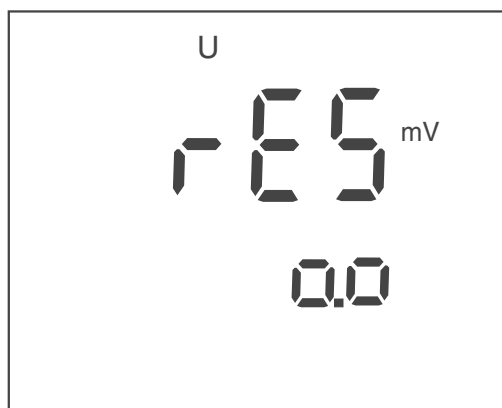
**U resolution  
(res)**

- |    |  |
|----|--|
| 10 | Using < > < > >, select the unit for the voltage display.  |
| 11 | Confirm with <ENTER>. <i>Unit</i> , the setting of the unit of the temperature value is displayed. |



### Temperature unit (*Unit*)



- |    |   |
|----|---|
| 12 | Using <><>, toggle between °C and °F.   |
| 13 | Confirm with <ENTER>.<br><i>Int.C</i> , the setting of the calibration interval is displayed. |

### Calibration interval (*Int.C*)

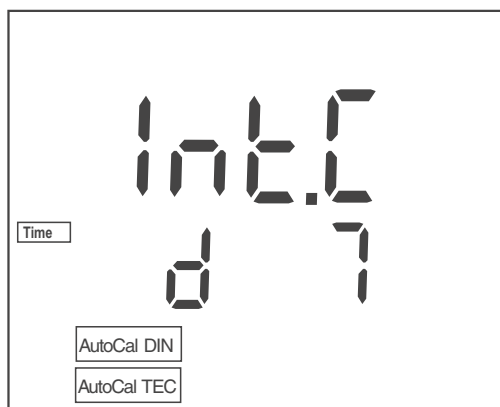

- |    |   |
|----|---|
| 14 | Set the interval with <><>.   |
| 15 | Confirm with <ENTER>.<br>The measurement settings are completed.<br>The meter switches to the measuring mode. |

## 4.6 Reset

### 4.6.1 Resetting calibration values

This function resets the calibration values to the default condition. All other meter settings are retained.

#### Calibration values in the default condition

Zero point	0 mV (pH 7.000)
Slope	-59.16 mV/pH (100 %)



#### Note

The measuring system is not calibrated after a reset. Before measuring, recalibrate the meter.

#### Resetting calibration values

- 1 Press <On/Off\_\_> to open the menu for the reset of the calibration data.  
*Init.C* is displayed.

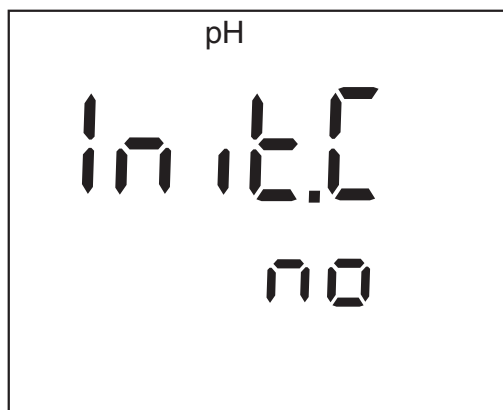

- 2 Press <>>> to display *no* or *YES*.  
*YES*: Reset the calibration values.  
*no*: Retain the calibration values.
- 3 Confirm with <ENTER>.  
The menu is finished.  
The meter switches to the measuring mode.

### 4.6.2 Resetting all meter settings

This function resets all meter settings to the default condition. The relevant values are given in the following sections:

System settings	section 4.5.1
Measurement settings	section 4.5.2

#### Resetting the meter settings

- 1 Switch on the meter with **<On/Off>**.  
The display test appears briefly on the display.
- 2 During the display test, press **<M>** to open the menu for the reset of the meter settings.  
*Init* is displayed.



- 3 Press **<>>>** to display *no* or *YES*.  
*YES*: Reset the meter settings.  
*no*: Retain the meter settings.
- 4 Confirm with **<ENTER>**.  
The menu is finished.  
The meter switches to the measuring mode.



#### Note

The measuring system is not calibrated after a reset. Before measuring, recalibrate the meter.



## 5 Maintenance, cleaning, disposal

### 5.1 Maintenance

The only maintenance activity required is replacing the batteries.

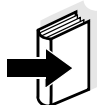

#### Note

See the relevant operating manuals of the combination electrodes for instructions on maintenance.

#### 5.1.1 Replacing the batteries

- |   |   |
|---|---|
| 1 | Unscrew the two screws (1) on the underside of the meter.       |
| 2 | Open the battery compartment (2) on the underside of the meter. |

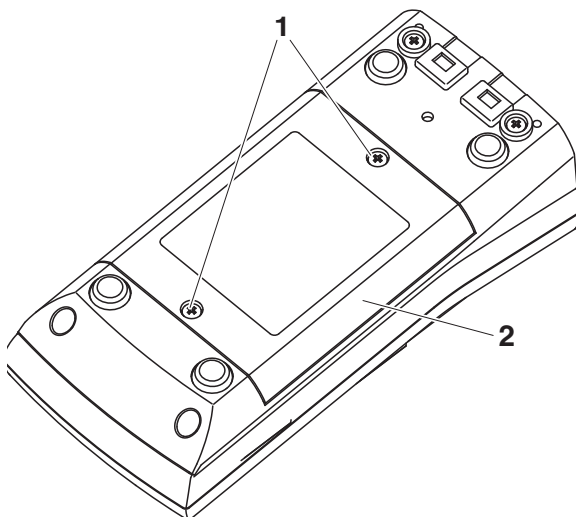

- |   |   |
|---|---|
| 3 | Remove the four batteries from the battery compartment.               |
| 4 | Place four new batteries (type Mignon AA) in the battery compartment. |



#### Note

Alternatively, you can also use Ni-MH rechargeable batteries (type Mignon AA). In order to charge the batteries, an external charging device is required.



#### Caution

**Make sure that the poles of the batteries are positioned correctly. The  $\pm$  signs on the batteries must correspond to the  $\pm$  signs in the battery compartment.**

- 5 Close the battery compartment (2) and tighten the screws (1).

## 5.2 Cleaning

Occasionally wipe the outside of the meter with a damp, lint-free cloth. Disinfect the housing with isopropanol as required.



### Caution

**The housing is made of synthetic material (ABS). Thus, avoid contact with acetone or similar detergents that contain solvents. Remove any splashes immediately.**

## 5.3 Packing

This meter is sent out in a protective transport packing. We recommend: Keep the packing material. The original packing protects the meter against damage during transport.

## 5.4 Disposal



### Note

This meter contains batteries. Batteries that have been removed must only be disposed of at a recycling facility set up for this purpose or via the retail outlet.

It is illegal to dispose of them in household refuse.

## 6 What to do if...

### Error message *OFL, UFL*

Cause	Remedy
pH combination electrode:	
– Measured value outside the measuring range	– Use suitable combination electrode
– Air bubble in front of the diaphragm	– Remove air bubble
– Air in the diaphragm	– Extract air or moisten diaphragm
– Cable broken	– Replace combination electrode
– Gel electrolyte dried out	– Replace combination electrode

### Error message *CalError*

Cause	Remedy
pH combination electrode:	
– The values determined for zero point and slope of the combination electrode are outside the allowed limits.	– Recalibrate
– Diaphragm contaminated	– Clean diaphragm
– Combination electrode broken	– Replace combination electrode
Buffer solutions	
– Incorrect buffer solutions	– Change calibration procedure
– Buffer solutions too old	– Use only once. Note the shelf life
– Buffer solutions depleted	– Change solutions

**No stable measured value**

<b>Cause</b>	<b>Remedy</b>
pH combination electrode:	
– Diaphragm contaminated	– Clean diaphragm
– Membrane contaminated	– Clean membrane
Test sample:	
– pH value not stable	– Measure with air excluded if necessary
– Temperature not stable	– Adjust temperature if necessary
Combination electrode + test sample:	
– Conductivity too low	– Use suitable combination electrode
– Temperature too high	– Use suitable combination electrode
– Organic liquids	– Use suitable combination electrode

**Sensor symbol flashes**

<b>Cause</b>	<b>Remedy</b>
– Calibration interval expired	– Recalibrate the measuring system

**Display, LoBat**

<b>Cause</b>	<b>Remedy</b>
– Batteries almost empty	– Replace the batteries (see section 5.1 MAINTENANCE)



<b>Obviously incorrect measured values</b>	<b>Cause</b>	<b>Remedy</b>
	pH combination electrode:	
	– pH combination electrode unsuitable	– Use suitable combination electrode
	– Temperature difference between buffer and test sample too high	– Adjust temperature of buffer or sample solutions
	– Measurement procedure not suitable	– Follow special procedure
<b>Meter does not react to keystroke</b>	<b>Cause</b>	<b>Remedy</b>
	– Operating condition undefined or EMC load unallowed	– Processor reset: Press the <b>&lt;ENTER&gt;</b> and <b>&lt;On/Off&gt;</b> key simultaneously
<b>You want to know which software version is in the meter</b>	<b>Cause</b>	<b>Remedy</b>
	– E. g., a question by the service department	– Switch on the meter. During the display test, display the software version with <b>&lt;ENTER&gt;</b> .



## 7 Technical data

### 7.1 General data

<b>Dimensions</b>	approx. 180 x 80 x 55 mm	
<b>Weight</b>	approx. 0.4 kg	
<b>Mechanical structure</b>	Type of protection	IP 67
<b>Electrical safety</b>	Protective class	III
<b>Test certificates</b>	CE	
<b>Ambient conditions</b>	Storage	- 25 °C ... + 65 °C
	Operation	-10 °C ... + 55 °C
	Allowable relative humidity	Annual mean: < 75 % 30 days/year: 95 % Other days: 85 %
<b>Power supply</b>	Batteries	4 x 1.5 V alkali-manganese batteries, type AA
	Rechargeable batteries	4 x 1,2 V NiMH rechargeable batteries, type AA (no charging function)
	Operational life	Approx. 2500 h operating hours (batteries)
<b>Sensor input</b>	Input resistance	> 5 * 10 <sup>12</sup> ohm
	Input current	< 1 * 10 <sup>-12</sup> A
<b>Guidelines and norms used</b>	EMC	EC directive 2004/108/EC EN 61326-1 EN 61000-3-2 EN 61000-3-3 FCC Class A
	Meter safety	EC directive 2006/95/EC EN 61010-1
	IP protection	EN 60529

## 7.2 Measuring ranges, resolution, accuracy

### Measuring ranges, resolution

Variable	Measuring range	Resolution
pH	- 2.0 ... + 20.0	0.1
	- 2.00 ... + 20.00	0.01
	- 2.000 ... + 19.999	0.001
U [mV]	- 1200.0 ... + 1200.0	0.1
	- 2000 ... + 2000	1
T [°C]	- 5.0 ... + 105.0	0.1
T [°F]	23.0 ... + 221.0	0.1

### Manual temperature input

Variable	Range	Increment
T <sub>manual</sub> [°C]	- 25 ... + 130	1
T <sub>manual</sub> [°F]	-13 ... + 266	1

### Accuracy (± 1 digit)

Variable	Accuracy	Temperature of the test sample
<b>pH / range *</b>		
- 2.0 ... + 20.0	± 0.1	+ 15 °C ... + 35 °C
- 2.00 ... + 20.00	± 0.01	+ 15 °C ... + 35 °C
- 2.000 ... + 19.999	± 0.005	+ 15 °C ... + 35 °C
<b>U [mV] / range</b>		
- 2000 ... + 2000	± 1	+ 15 °C ... + 35 °C
-1200.0 ... +1200.0	± 0.3	+ 15 °C ... + 35 °C
<b>T [°C] / temperature sensor</b>		
NTC 30	± 0.1	
PT 1000	± 0.1	

\* when measuring in a range of ± 2 pH around a calibration point



### Note

The accuracy values specified here apply exclusively to the meter. The accuracy of the combination electrodes and buffer solutions has to be taken into account additionally.

## 8 Lists

This chapter provides additional information and orientation aids.

**Specialist terms** The glossary briefly explains the meaning of the specialist terms. However, terms that should already be familiar to the target group are not described here.

**Index** The index helps you to find the topics that you are looking for.

### Glossary

**Adjusting** To manipulate a measuring system so that the relevant value (e. g. the displayed value) differs as little as possible from the correct value or a value that is regarded as correct, or that the difference remains within the tolerance.

**Asymmetry** see zero point

**AutoRange** Name of the automatic selection of the measuring range.

**AutoRead** Function to control the measured value stability.

**Calibration** Comparing the value from a measuring system (e. g. the displayed value) to the correct value or a value that is regarded as correct. Often, this expression is also used when the measuring system is adjusted at the same time (see adjusting).

**Electromotive force of a combination electrode** The electromotive force  $U$  of the combination electrode is the measurable electromotive force of an electrode in a solution. It equals the sum of all the galvanic voltages of the electrode. Its dependency on the pH results in the electrode function, which is characterized by the parameters, slope and zero point.

**Junction** The junction is a porous body in the housing wall of reference electrodes or electrolyte bridges. It arranges the electrical contact between two solutions and makes the electrolyte exchange more difficult. The expression, junction, is also used for ground or junction-less transitions.

**Measured parameter** The measured parameter is the physical dimension determined by measuring, e. g. pH, conductivity or D.O. concentration.

---

<b>Measured value</b>	The measured value is the special value of a measured parameter to be determined. It is given as a combination of the numerical value and unit (e. g. 3 m; 0.5 s; 5.2 A; 373.15 K).
<b>Molality</b>	Molality is the quantity (in Mol) of a dissolved substance in 1000 g solvent.
<b>ORP voltage</b>	The ORP is caused by oxidizing or reducing substances dissolved in water, if these substances become effective at an electrode surface (e. g. a gold or platinum surface).
<b>pH value</b>	The pH is a measure of the acidic or basic effect of an aqueous solution. It corresponds to the negative decadic logarithm of the molal hydrogen ions activity divided by the unit of the molality. The practical pH value is the value of a pH measurement.
<b>Potentiometry</b>	Name of a measuring technique. The signal (depending on the measured parameter) of the electrode is the electrical potential. The electrical current remains constant.
<b>Reset</b>	Restoring the original condition of all settings of a measuring system.
<b>Resolution</b>	Smallest difference between two measured values that can be displayed by a measuring instrument.
<b>Slope</b>	The slope of a linear calibration function.
<b>Standard solution</b>	The standard solution is a solution where the measured value is known by definition. It is used to calibrate a measuring system.
<b>Test sample</b>	Designation of the test sample ready to be measured. Normally, a test sample is made by processing the original sample. The test sample and original sample are identical if the test sample was not processed.
<b>Zero point</b>	The zero point of a pH electrode is the pH value at which the electromotive force of the pH electrode at a specified temperature is zero. Normally, this is at 25 °C.

**Index****A**

Authorized use	10
AutoCal	22
AutoRead	16

**B**

Battery compartment	13, 37
---------------------	--------

**C**

Calibration	19
Calibration evaluation	
pH	20
Calibration interval	21
Calibration points	
pH	19
ConCal	19, 24
Copyright	2

**D**

Display	7
---------	---

**E**

Energy saving feature	14
-----------------------	----

**I**

Initial commissioning	14
Interval	
Calibration	21

**K**

Keys	6
------	---

**L**

LoBat	40
-------	----

**M**

Measurement accuracy	21
----------------------	----

**O**

Operational safety	10
ORP electrode	18
ORP voltage	18

**P**

Precautions	9
-------------	---

**R**

Reset	34
All meter settings	35
Calibration values	34
Resolution setting	30, 31, 32

**S**

Safety	9
Scope of delivery	13
Single-point calibration	19, 23, 25
Slope	
pH	19
Socket field	8
Stability control	16

**T**

Two-point calibration	19
ConCal	24

**Z**

Zero point of pH combination electrode	19
--	----







# Xylem |'zīləm|

- 1) The tissue in plants that brings water upward from the roots;
- 2) a leading global water technology company.

We're a global team unified in a common purpose: creating advanced technology solutions to the world's water challenges. Developing new technologies that will improve the way water is used, conserved, and re-used in the future is central to our work. Our products and services move, treat, analyze, monitor and return water to the environment, in public utility, industrial, residential and commercial building services settings. Xylem also provides a leading portfolio of smart metering, network technologies and advanced analytics solutions for water, electric and gas utilities. In more than 150 countries, we have strong, long-standing relationships with customers who know us for our powerful combination of leading product brands and applications expertise with a strong focus on developing comprehensive, sustainable solutions.

**For more information on how Xylem can help you, go to [www.xylem.com](http://www.xylem.com).**



## **Service and Returns:**

Xylem Analytics Germany  
Sales GmbH & Co. KG  
WTW  
Am Achalaich 11  
82362 Weilheim  
Germany

Tel.: +49 881 183-325  
Fax: +49 881 183-414  
E-Mail [wtw.rma@xylem.com](mailto:wtw.rma@xylem.com)  
Internet: [www.xylemanalytics.com](http://www.xylemanalytics.com)



Xylem Analytics Germany GmbH  
Am Achalaich 11  
82362 Weilheim  
Germany

