

Oxi 3205

DISSOLVED OXYGEN (D.O.) METER



a xylem brand

Copyright

© 2017 Xylem Analytics Germany GmbH
Printed in Germany.

Oxi 3205 - Contents

1	Overview	5
1.1	Keypad	6
1.2	Display	7
1.3	Socket field	8
2	Safety	9
2.1	Authorized use	10
2.2	General safety instructions	10
3	Commissioning	13
3.1	Scope of delivery	13
3.2	Initial commissioning	13
4	Operation	15
4.1	Switching on the meter	15
4.2	General operating principles	16
4.2.1	Operating modes	16
4.2.2	Navigation	17
4.2.3	Example on navigation: Setting the language	19
4.3	Sensor-independent settings	21
4.3.1	Setting in the <i>Configuration</i> menu	21
4.3.2	<i>Automatic Stability control</i>	21
4.4	Dissolved oxygen	22
4.4.1	General information	22
4.4.2	Measuring	23
4.4.3	Settings for D.O. sensors (menu or measurement and calibration settings)	24
4.4.4	D.O. calibration	25
4.4.5	Displaying calibration records	27
4.5	Reset	28
4.5.1	Resetting the measurement settings	28
4.5.2	Resetting the system settings	29
5	Maintenance, cleaning, disposal	31
5.1	Maintenance	31
5.1.1	Replacing the batteries	31
5.2	Cleaning	32
5.3	Packing	32
5.4	Disposal	32

6	What to do if...	33
7	Technical data	35
7.1	General data	35
7.2	Measuring ranges, resolution, accuracy	36
8	Lists	39

1 Overview

The Oxi 3205 compact precision dissolved oxygen (D.O.) meter enables you to perform D.O. measurements quickly and reliably.

The Oxi 3205 provides the maximum degree of operating comfort, reliability and measuring certainty for all applications. The proven OxiCal calibration procedure supports you in your work with the D.O. meter.

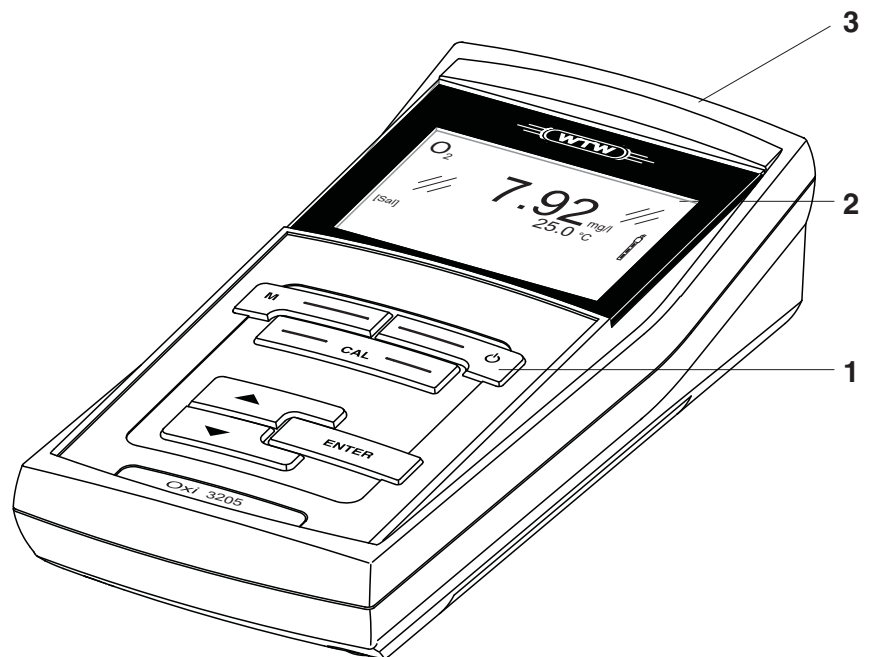





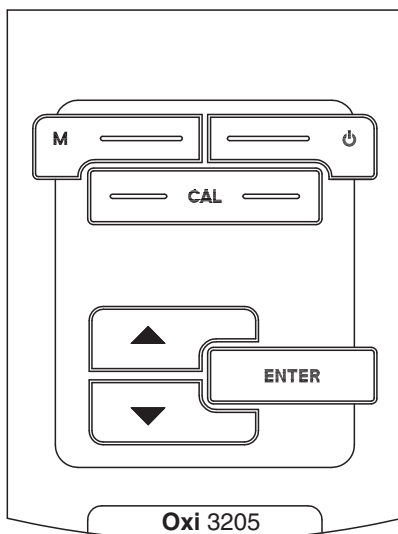

1	Keypad
2	Display
3	Socket field

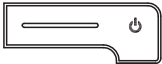
1.1 Keypad



In this operating manual, keys are indicated by brackets <...> .
 The key symbol (e.g. <ENTER>) generally indicates a short keystroke (under 2 sec) in this operating manual. A long keystroke (approx. 2 sec) is indicated by the underscore behind the key symbol (e.g. <ENTER__>).

	<On/Off>:	Switches the meter on or off
	<M>:	Selects the measured parameter
	<CAL>: <CAL__>:	Calls up the calibration procedure Displays the calibration data
	<>:	Increments values, scrolls
	<>:	Decrements values, scrolls
	<ENTER>: <ENTER__>:	Opens the menu for measurement settings / confirms entries Opens the menu for system settings

1.2 Display

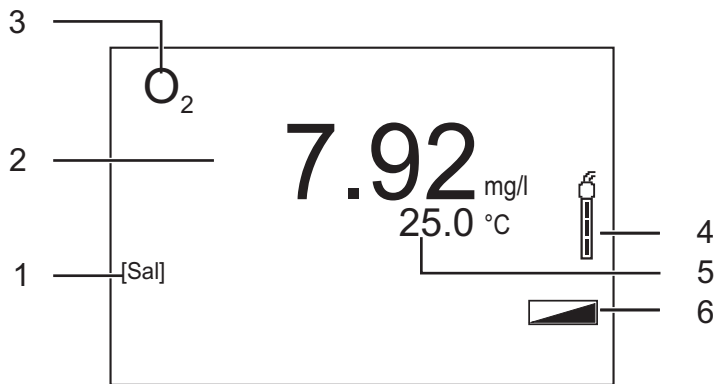

1	Status information
2	Measured value (with unit)
3	Measured parameter
4	Sensor symbol (calibration evaluation, calibration interval)
5	Measured temperature (with unit)
6	Status line

Function display indicators

Error	An error occurred during calibration
-------	--------------------------------------

1.3 Socket field

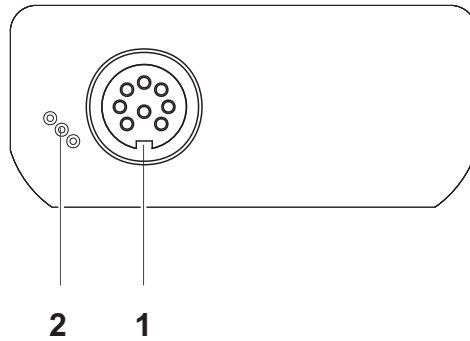

Connectors:

1	D.O. sensor
2	Service interface



Caution

Only connect D.O. sensors to the meter that cannot return any voltages or currents that are not allowed (> SELV and > current circuit with current limiting).

Almost all customary D.O. sensors fulfill these conditions.

2 Safety

This operating manual contains basic instructions that you must follow during the commissioning, operation and maintenance of the meter. Consequently, all responsible personnel must read this operating manual before working with the meter.

The operating manual must always be available within the vicinity of the meter.

Target group

The meter was developed for work in the field and in the laboratory. Thus, we assume that, as a result of their professional training and experience, the operators will know the necessary safety precautions to take when handling chemicals.

Safety instructions

Safety instructions in this operating manual are indicated by the warning symbol (triangle) in the left column. The signal word (e.g. "Caution") indicates the level of danger:



Warning

indicates instructions that must be followed precisely in order to avoid possibly great dangers to personnel.



Caution

indicates instructions that must be followed precisely in order to avoid the possibility of slight injuries or damage to the meter or the environment.

Further notes



Note

indicates notes that draw your attention to special features.



Note

indicates cross-references to other documents, e.g. operating manuals.

2.1 Authorized use

The authorized use of the meter consists exclusively of the measurement of dissolved oxygen and temperature of liquid media in a field and laboratory environment.

The technical specifications as given in chapter 7 TECHNICAL DATA must be observed. Only the operation and running of the meter according to the instructions given in this operating manual is authorized.

Any other use is considered **unauthorized**.

2.2 General safety instructions

This meter is constructed and tested in compliance with the IEC 1010 safety regulations for electronic measuring instruments.

It left the factory in a safe and secure technical condition.

Function and operational safety

The smooth functioning and operational safety of the meter can only be guaranteed if the generally applicable safety measures and the specific safety instructions in this operating manual are followed during operation.

The smooth functioning and operational safety of the meter can only be guaranteed under the environmental conditions that are specified in chapter 7 TECHNICAL DATA.

If the meter was transported from a cold environment to a warm environment, the formation of condensate can lead to the faulty functioning of the meter. In this event, wait until the temperature of the meter reaches room temperature before putting the meter back into operation.

Caution

The meter is only allowed to be opened by authorized personnel.



Safe operation

If safe operation is no longer possible, the meter must be taken out of service and secured against inadvertent operation!

Safe operation is no longer possible if the meter:

- has been damaged in transport
- has been stored under adverse conditions for a lengthy period of time
- is visibly damaged
- no longer operates as described in this manual.

If you are in any doubt, please contact the supplier of the meter.

Obligations of the purchaser

The purchaser of this meter must ensure that the following laws and guidelines are observed when using dangerous substances:

- EEC directives for protective labor legislation
- National protective labor legislation
- Safety regulations
- Safety datasheets of the chemical manufacturers.

**Caution**

In addition to the safety instructions mentioned here, also follow the safety instructions of the sensors used.

The operating manuals of the sensors are available on the supplied CD and on the Internet under www.WTW.com.

3 Commissioning

3.1 Scope of delivery

- D.O. meter Oxi 3205
- 4 batteries 1.5 V Mignon type AA
- Short instructions
- CD-ROM with detailed operating manual

3.2 Initial commissioning

Inserting the batteries

- | | |
|---|---|
| 1 | Unscrew the two screws (1) on the underside of the meter. |
| 2 | Open the battery compartment (2) on the underside of the meter. |

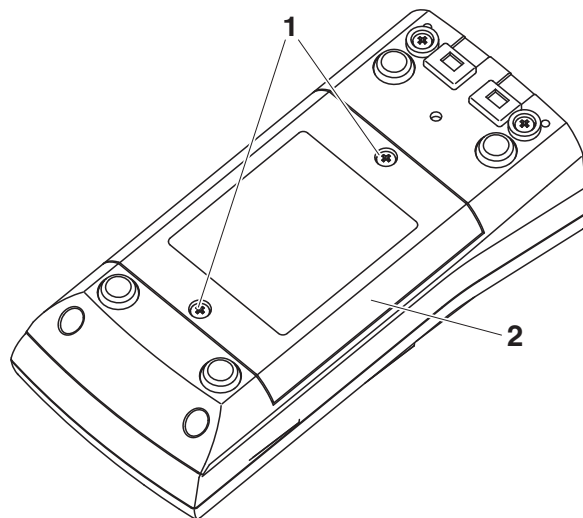

- | | |
|---|---|
| 3 | Place four batteries (type Mignon AA) in the battery compartment. |
|---|---|



Note

Alternatively, you can also use Ni-MH rechargeable batteries (type Mignon AA). In order to charge the batteries, an external charging device is required.



Caution

Make sure that the poles of the batteries are positioned correctly. The \pm signs on the batteries must correspond to the \pm signs in the battery compartment.

- 4 Close the battery compartment (2) and tighten the screws (1).

Switching on the meter

- 1 Press the **<On/Off>** key.
The meter performs a self-test.
The display shows the manufacturer's logo while the self-test is being performed.
Subsequently, the meter switches to the measuring mode (measured value display).



Note

The meter has an energy saving feature to avoid unnecessary battery depletion.

The energy saving feature switches off the measuring instrument if no key is pressed during the adjusted interval. (How to set the switch-off interval, see section 4.3).

4 Operation

4.1 Switching on the meter

Switching on

Press the <On/Off> key.

The meter performs a self-test.

The display shows the manufacturer's logo while the self-test is being performed.

The measured value display appears.

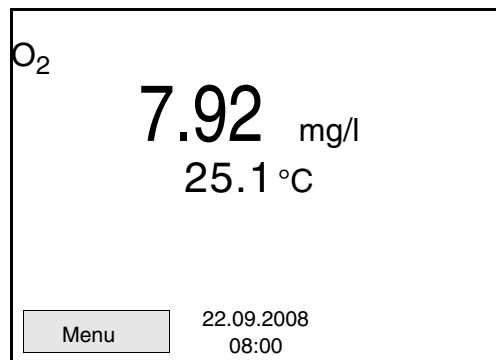

Switching off

Press the <On/Off> key.

Automatic switch-off function

The instrument has an automatic switch-off function in order to save the batteries (see section 4.3). The automatic switch-off function switches off the measuring instrument if no key is pressed for an adjustable period.

Display illumination

The meter automatically switches off the display illumination if no key is pressed for 30 seconds. The illumination is switched on with the next keystroke again.

You can also generally switch the display illumination on or off (see section 4.3).

4.2 General operating principles

This section contains basic information on the operation of the Oxi 3205.

Operating elements, display

An overview of the operating elements and the display is given in section 1.1 and section 1.2.

Operating modes, navigation

An overview of the operating modes and navigation of the Oxi 3205 is given in section 4.2.1 and section 4.2.2.

4.2.1 Operating modes

The meter has the following operating modes:

- Measuring
The measurement data of the connected sensor is shown in the measured value display
- Calibration
The course of a calibration with calibration information, functions and settings is displayed
- Setting
The system menu or a sensor menu with submenus, settings and functions is displayed

4.2.2 Navigation

Measured value display

In the measured value display, you can

- Open the menu for calibration and measurement settings with **<ENTER>** (short keystroke)
- Open the *Configuration* menu with the sensor-independent settings with **<ENTER__>** (long keystroke (approx. 2 s)).
- Change the display in the measurement window by pressing **<M>** (e.g. D.O. concentration → D.O. saturation index → D.O. partial pressure →).

Menus and dialogs

The menus for settings and dialogs in procedures contain further submenus. The selection is made with the **<><>** keys. The current selection is displayed with a frame.

- Settings

Settings are indicated by a colon. The current setting is displayed on the right-hand side. The setting mode is opened with **<ENTER>**. Subsequently, the setting can be changed with **<><>** and **<ENTER>**. Example:

Configuration	
Language:	English
Illumination:	On
Contrast:	48 %
Switchoff time:	30 min
Service information	
Reset	

- Functions

Functions are designated by the name of the function. They are immediately carried out by confirming with **<ENTER>**. Example: Display the *Calibration record* function.

O ₂	
Calibration record	
Calibration interval:	14 d
Temperature unit	°C
Sal correction	Off
Reset	
i Air pressure = 941 mbar	

Messages Information is marked by the **i** symbol. It cannot be selected. Example:

O₂

Calibration record	
Calibration interval:	14 d
Temperature unit	°C
Sal correction	Off
Reset	
i Air pressure = 941 mbar	

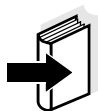

Note

The principles of navigation are explained in the section "Setting the language" by reference of an example (see section 4.2.3).

4.2.3 Example on navigation: Setting the language

- 1 Press the <On/Off> key.
The measured value display appears.
The instrument is in the measuring mode.

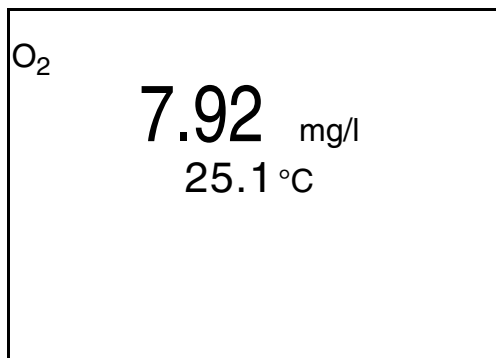

- 2 Using <ENTER> open the *Configuration* menu.
The instrument is in the setting mode.

Configuration	
Language:	English
Beep:	Off
Illumination:	On
Contrast:	48 %
Switchoff time:	30 min
Service information	
Reset	

- 3 Select the *Language* submenu with <>< >.
The current selection is displayed with a frame.
- 4 Open the setting mode for the *Language* with <ENTER>.

Configuration

Language:	Deutsch
Illumination:	On
Contrast:	48 %
Switchoff time:	30 min
Service information	
Reset	

- 5 | Select the required language with < >< >.
- 6 | Confirm the setting with **<ENTER>**.
The meter switches to the measuring mode.
The selected language is active.

4.3 Sensor-independent settings

4.3.1 Setting in the *Configuration* menu

To open the *Configuration* menu, press the <ENTER__> key in the measured value display. After completing the settings, switch to the measured value display with <M>.

Menu item	Setting	Description
<i>Language</i>	<i>Deutsch</i> <i>English</i> (further)	Select the menu language
<i>Illumination</i>	<i>Auto</i> <i>On</i> <i>Off</i>	Switching the display illumination on/off
<i>Contrast</i>	0 ... 100 %	Changing the display contrast
<i>Switchoff time</i>	10 min ... 24 h	Adjust the switch-off time
<i>Service information</i>		Hardware version and software version of the meter are displayed.
<i>Reset</i>	-	Resets the system settings to the default values. For details, see section 4.5.2

4.3.2 Automatic *Stability control*

The function, automatic *Stability control* (AutoRead) continually checks the stability of the measurement signal. The stability has a considerable impact on the reproducibility of measured values.

The measured parameter flashes on the display

- as soon as the measured value is outside the stability range
- if you switch over between the measured parameters with <M>.

4.4 Dissolved oxygen

4.4.1 General information

You can measure the following parameters:

- D.O. concentration
- D.O. saturation index ("D.O. saturation")
- D.O. partial pressure

D.O. measurements with the Oxi 3205 can be carried out with the CellOx 325 or DurOx 325 D.O. sensor.

The measuring instrument automatically recognizes the type of the connected D.O. sensor.

Temperature measurement

The CellOx 325 and DurOx 325 D.O. sensors have an integrated temperature sensor.

Preparatory activities

Perform the following preparatory activities when you want to measure:

1	Connect the D.O. sensor to the meter. The D.O. measuring window is displayed.
2	Calibrate or check the meter with the sensor.



Note

Incorrect calibration of D.O. sensors will result in incorrect measured values. Calibrate at regular intervals.

4.4.2 Measuring

You can carry out D.O. measurements as follows:

1	Perform the preparatory activities according to section 4.4.1.
2	Immerse the D.O. sensor in the test sample.

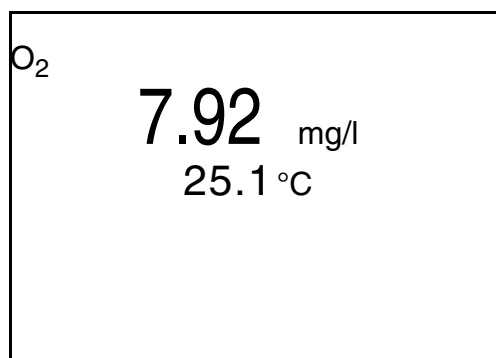

Selecting the displayed measured parameter

You can switch between the following displays with **<M>**:

- D.O. concentration [mg/l]
- D.O. saturation [%]
- D.O. partial pressure [mbar].

Salinity correction

When measuring the concentration of sea water, a salinity correction is required. When the salinity correction is switched on, the *[Sal]* indicator is displayed in the measuring window.

You can switch the salinity correction on or off and enter the salinity in the menu for calibration and measurement settings (see section 4.4.3).

Stability control (AutoRead)

The stability control function (AutoRead) continually checks the stability of the measurement signal. The stability has a considerable impact on the reproducibility of measured values. The display of the measured parameter flashes until a stable measured value is available.

Criteria for a stable measured value

The *Stability control* function checks whether the measured values are stable within the monitored time interval.

Measured parameter	Time interval	Stability in the time interval
D.O. concentration	20 seconds	Δ : Better than 0.05 mg/l
D.O. saturation	20 seconds	Δ : Better than 0.6 %
D.O. partial pressure	20 seconds	Δ : Better than 1.2 mbar
Temperature	15 seconds	Δ : Better than 0.5 °C

The minimum duration until a measured value is assessed as stable is the monitored time interval. The actual duration is mostly longer.

4.4.3 Settings for D.O. sensors (menu or measurement and calibration settings)

The settings are available in the menu for measurement and calibration settings. To open the settings, display the required parameter in the measured value display and press the <ENTER> or <ENTER> key. After completing the settings, switch to the measured value display with <M>.



Menu item	Possible setting	Description
<i>Calibration record</i>	-	Displays the calibration record of the last calibration.
<i>Calibration interval</i>	1 ... 999 d	<i>Calibration interval</i> for the D.O. sensor (in days). The meter reminds you to calibrate regularly by the flashing sensor symbol in the measuring window.
<i>Temperature unit</i>	°C °F	Temperature unit, degrees Celsius or degrees Fahrenheit. All temperatures are displayed with the selected unit.
<i>Sal correction</i>	<i>On</i> <i>Off</i>	Manual salt content correction for concentration measurements.
<i>Reset</i>	-	Resets all sensor settings to the delivery condition (see section 4.5.1).

4.4.4 D.O. calibration

Why calibrate?	D.O. sensors age. This changes the slope of the D.O. sensor. Calibration determines the current slope of the sensor and stores this value in the instrument.
When to calibrate?	<ul style="list-style-type: none">● After connecting another D.O. sensor● When the sensor symbol flashes (after the calibration interval has expired).
Calibration datasets	<p>The Oxi 3205 administrates two sets of calibration data:</p> <ul style="list-style-type: none">● Set 1 for the type, "CellOx": – CellOx 325● Set 2 for the type, "DurOx": – DurOx 325 <p>Sensors of different types can be calibrated separately from each other. When one sensor type is calibrated, the calibration data of the other type remains stored. The Oxi 3205 recognizes the type of the connected sensor and automatically uses the correct calibration data.</p>
Calibration procedure	Calibration in water vapor-saturated air. Use an OxiCal [®] air calibration vessel for calibration.
Stability control (AutoRead)	In calibration, the Stability control function (AutoRead) is automatically activated.
Display calibration data	You can have the data of the last calibration displayed (see section 4.4.5).

Calibration evaluation

After the calibration, the measuring instrument automatically evaluates the current status of the calibration. The evaluation appears on the display and in the calibration record.

Display	Calibration record	Relative slope
	+++	$S = 0.8 \dots 1.25$
	++	$S = 0.7 \dots 0.8$
	+	$S = 0.6 \dots 0.7$
<i>Error</i>	<i>Error</i>	$S < 0.6$ or $S > 1.25$

Eliminate the error according to chapter 6 WHAT TO DO IF...

Calibration in water vapor saturated air (air calibration vessel)

Proceed as follows to calibrate the instrument:

- 1 | Connect the D.O. sensor to the meter.
- 2 | Put the D.O. sensor into the air calibration vessel.



Note

The sponge in the air calibration vessel must be moist (not wet). Leave the sensor in the air calibration vessel for a time long enough to adjust.

- 3 | Start the calibration with **<CAL>**.
The last calibration data (relative slope) is displayed.

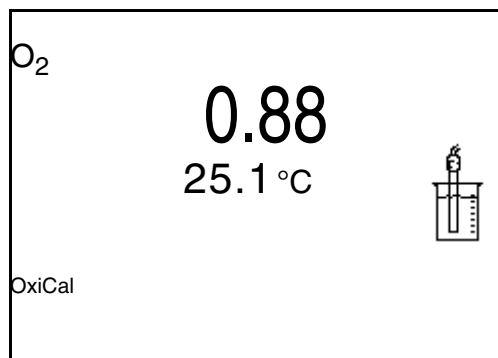

4	Start the measurement with <ENTER> . The measured value is checked for stability (stability control). The [AR] status indicator is displayed. The measured parameter flashes.
5	Wait for the end of the AutoRead measurement or accept the calibration value with <ENTER> . The calibration record is displayed.
6	Using <ENTER> , switch to the measured value display.

4.4.5 Displaying calibration records

Displaying the calibration record

The calibration record of the last calibration is to be found under the menu item, *Calibration record*. To open it in the measured value display, press the **<CAL__>** key.

4.5 Reset

You can reset (initialize) all sensor settings and sensor-independent settings separately from each other.

4.5.1 Resetting the measurement settings



Note

The calibration data are reset to the default settings together with the measuring parameters. Recalibrate after performing a reset.

The following settings for D.O. measurements are reset to the default settings with the *Reset* function:

Setting	Default settings
Cal. interval	14 d
Comparison meas.	Off
Measured parameter	D.O. concentration
Relative slope (S_{Rel})	1.00
Salinity (function)	Off
Temperature unit	°C

The sensor settings are reset under the *Reset* menu item in the menu for calibration and measurement settings. To open the settings, display the required parameter in the measured value display and press the **<ENTER>** key.

4.5.2 Resetting the system settings

The following system settings can be reset to the delivery status:

Setting	Default settings
Language	English
Contrast	50 %
Illumination	Auto
Switchoff time	1 h

The system settings are reset in the menu, *Configuration / System / Reset*. To open the *Configuration* menu, press the **<ENTER__>** key in the measured value display.

5 Maintenance, cleaning, disposal

5.1 Maintenance

The only maintenance activity required is replacing the batteries.

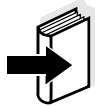

Note

See the relevant operating manuals of the D.O. sensors for instructions on maintenance.

5.1.1 Replacing the batteries

1	Unscrew the two screws (1) on the underside of the meter.
2	Open the battery compartment (2) on the underside of the meter.

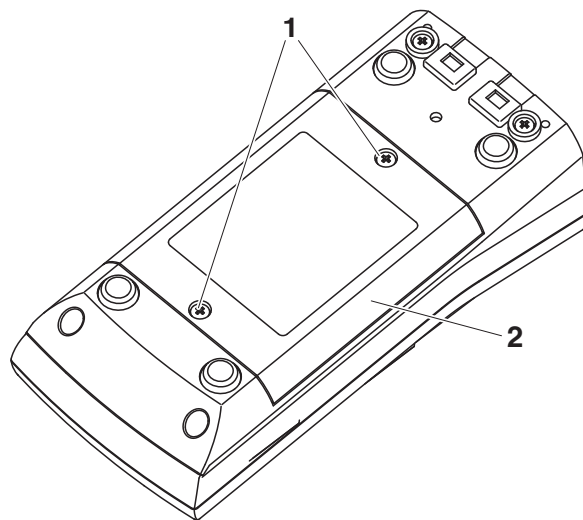

3	Remove the four batteries from the battery compartment.
4	Place four new batteries (type Mignon AA) in the battery compartment.



Note

Alternatively, you can also use Ni-MH rechargeable batteries (type Mignon AA). In order to charge the batteries, an external charging device is required.



Caution

Make sure that the poles of the batteries are positioned correctly. The ± signs on the batteries must correspond to the ± signs in the battery compartment.

- 5 | Close the battery compartment (2) and tighten the screws (1).

5.2 Cleaning

Occasionally wipe the outside of the measuring instrument with a damp, lint-free cloth. Disinfect the housing with isopropanol as required.



Caution

The housing is made of synthetic material (ABS). Thus, avoid contact with acetone or similar detergents that contain solvents. Remove any splashes immediately.

5.3 Packing

This meter is sent out in a protective transport packing. We recommend: Keep the packing material. The original packing protects the meter against damage during transport.

5.4 Disposal



Note

This meter contains batteries. Batteries that have been removed must only be disposed of at a recycling facility set up for this purpose or via the retail outlet.

It is illegal to dispose of it in household refuse.

6 What to do if...

Error message, <i>OFL</i>	Cause <ul style="list-style-type: none"> – Measured value outside the measuring range 	Remedy <ul style="list-style-type: none"> – Use a suitable D.O. sensor
Error message, <i>Error</i>	Cause <ul style="list-style-type: none"> – D.O. sensor contaminated 	Remedy <ul style="list-style-type: none"> – Clean D.O. sensor and replace it if necessary
Sensor symbol flashes	Cause <ul style="list-style-type: none"> – Cleaning interval expired 	Remedy <ul style="list-style-type: none"> – Recalibrate the measuring system
 Display	Cause <ul style="list-style-type: none"> – Batteries almost empty 	Remedy <ul style="list-style-type: none"> – Replace the batteries (see section 5.1 MAINTENANCE)
Meter does not react to keystroke	Cause <ul style="list-style-type: none"> – Operating condition undefined or EMC load unallowed 	Remedy <ul style="list-style-type: none"> – Processor reset: Press the <ENTER> and <On/Off> key simultaneously
You want to know which software version is in the meter	Cause <ul style="list-style-type: none"> – E. g., a question by the service department 	Remedy <ul style="list-style-type: none"> – Switch on the meter. With <ENTER__> and <>> open the menu <i>Service Information</i>. The instrument data is displayed.

7 Technical data

7.1 General data

Dimensions	approx. 180 x 80 x 55 mm	
Weight	approx. 0.4 kg	
Mechanical structure	Type of protection	IP 67
Electrical safety	Protective class	III
Test certificates	CE	
Ambient conditions	Storage	- 25 °C ... + 65 °C
	Operation	-10 °C ... + 55 °C
	Allowable relative humidity	Annual mean: < 75 % 30 days/year: 95 % Other days: 85 %
Power supply	Batteries	4 x 1.5 V alkali-manganese batteries, type AA
	Rechargeable batteries	4 x 1,2 V NiMH rechargeable batteries, type AA (no charging function)
	Operational life	up to 800 h without / 100 h with illumination
Guidelines and norms used	EMC	EC directive 2004/108/EC EN 61326-1 EN 61000-3-2 EN 61000-3-3 FCC Class A
	Meter safety	EC directive 2006/95/EC EN 61010-1
	IP protection class	EN 60529

7.2 Measuring ranges, resolution, accuracy

Measuring ranges, resolution

Note: The values quoted in brackets apply especially for the DurOx 325 sensor.

Parameter	Measuring range	Resolution
D.O. concentration [mg/l]	0 ... 20.00 (0 ... 20.0)	0.01 (0.1)
	0 ... 90.0 (0 ... 90)	0.1 (1)
Saturation [%]	0 ... 200.0 (0 ... 200)	0.1 (1)
	0 ... 600	1
D.O. partial pressure [mbar]	0 ... 200.0 (0 ... 200)	0.1 (1)
	0 ... 1250	1
T [°C]	0 ... 50.0	0.1

Accuracy (± 1 digit)

Parameter	Accuracy
D.O. concentration [mg/l]	± 0.5 % of measured value at ambient temperature + 5 °C ... + 30 °C
Saturation [%]	± 0.5% of measured value when measuring in the range of ± 10 K around the calibration temperature
D.O. partial pressure [mbar]	± 0.5 % of measured value at ambient temperature + 5 °C ... + 30 °C

T [°C] / temperature sensor

NTC 30	± 0,1
PT 1000	± 0,1

Correction functions

Temperature compensation	Accuracy better than 2 % at 0 ... + 40 °C
Salinity correction	35 SAL
Air pressure correction	Automatic through integrated pressure sensor in the range of 500 ... 1100 mbar



Note

The accuracy values specified here apply exclusively to the meter. The accuracy of the D.O. sensors has also to be taken into account.

FCC Class A Equipment Statement

Note: This equipment has been tested and found to comply with the limits for a Class A digital device, pursuant to Part 15 of the FCC Rules. These limits are designed to provide reasonable protection against harmful interference when the equipment is operated in a commercial environment. This equipment generates, uses, and can radiate radio frequency energy and, if not installed and used in accordance with the instruction manual, may cause harmful interference to radio communications. Operation of this equipment in a residential area is likely to cause harmful interference in which case the user will be required to correct the interference at his own expense. Changes or modifications not expressly approved by the manufacturer could void the user's authority to operate the equipment.

8 Lists

This chapter provides additional information and orientation aids.

Specialist terms The glossary briefly explains the meaning of the specialist terms. However, terms that should already be familiar to the target group are not described here.

Index The index will help you to find the topics that you are looking for.

Glossary

Adjusting	To manipulate a measuring system so that the relevant value (e. g. the displayed value) differs as little as possible from the correct value or a value that is regarded as correct, or that the difference remains within the tolerance.
AutoRange	Name of the automatic selection of the measuring range.
Calibration	Comparing the value from a measuring system (e. g. the displayed value) to the correct value or a value that is regarded as correct. Often, this expression is also used when the measuring system is adjusted at the same time (see adjusting).
D.O. partial pressure	Pressure caused by the oxygen in a gas mixture or liquid.
D.O. saturation	Short name for the relative D.O. saturation.
Measured parameter	The measured parameter is the physical dimension determined by measuring, e. g. pH, conductivity or D.O. concentration.
Measured value	The measured value is the special value of a measured parameter to be determined. It is given as a combination of the numerical value and unit (e. g. 3 m; 0.5 s; 5.2 A; 373.15 K).
OxiCal®	WTW name for a procedure to calibrate D.O. measuring systems in water vapor saturated air.
Reset	Restoring the original condition of all settings of a measuring system.
Resolution	Smallest difference between two measured values that can be displayed by a meter.

Salinity	The absolute salinity S_A of seawater corresponds to the relationship of the mass of dissolved salts to the mass of the solution (in g/Kg). In practice, this dimension cannot be measured directly. Therefore, the practical salinity according to IOT is used for oceanographic monitoring. It is determined by measuring the electrical conductivity.
Salt content	General designation for the quantity of salt dissolved in water.
Slope (relative)	Designation used by WTW in the D.O. measuring technique. It expresses the relation of the slope value to the value of a theoretical reference sensor of the same construction type.
Stability control	Function to control the measured value stability.
Test sample	Designation of the test sample ready to be measured. Normally, a test sample is made by processing the original sample. The test sample and original sample are identical if the test sample was not processed.

Index**A**

Air calibration beaker	25
Authorized use	10
Automatic switch-off	15
AutoRead	23

B

Battery compartment	13, 31
---------------------------	--------

C

Calibration evaluation	26
Copyright	2

D

Default settings	
Measured parameter	28
System settings	29

E

Energy saving feature	14
-----------------------------	----

I

Initial commissioning	13, 14
Initialize	28

K

Keys	6
------------	---

M

Measured value display	17
Measuring	23
Menus (navigation)	17
Messages	18

O

Operational safety	10
--------------------------	----

P

Precautions	9
-------------------	---

R

Reset	28
-------------	----

S

Safety	9
Sample display	7
Saving	28
Scope of delivery	13
Slope relative	25
Socket field	8
Stability control	
Automatic	21

T

Temperature measurement	22
-------------------------------	----

Xylem |'zīləm|

- 1) The tissue in plants that brings water upward from the roots;
- 2) a leading global water technology company.

We're a global team unified in a common purpose: creating advanced technology solutions to the world's water challenges. Developing new technologies that will improve the way water is used, conserved, and re-used in the future is central to our work. Our products and services move, treat, analyze, monitor and return water to the environment, in public utility, industrial, residential and commercial building services settings. Xylem also provides a leading portfolio of smart metering, network technologies and advanced analytics solutions for water, electric and gas utilities. In more than 150 countries, we have strong, long-standing relationships with customers who know us for our powerful combination of leading product brands and applications expertise with a strong focus on developing comprehensive, sustainable solutions.

For more information on how Xylem can help you, go to www.xylem.com.



Service and Returns:

Xylem Analytics Germany
Sales GmbH & Co. KG
WTW
Am Achalaich 11
82362 Weilheim
Germany

Tel.: +49 881 183-325
Fax: +49 881 183-414
E-Mail wtw.rma@xylem.com
Internet: www.xylemanalytics.com



Xylem Analytics Germany GmbH
Am Achalaich 11
82362 Weilheim
Germany

