

photoFlex[®] STD

LED FILTER PHOTOMETER



a xylem brand

Copyright © 2022 Xylem Analytics Germany GmbH
Printed in Germany.

Contents

| | | |
|----------|--|-----------|
| 1 | Overview | 6 |
| 1.1 | General features | 6 |
| 1.2 | Keypad | 7 |
| 1.3 | Display | 8 |
| 1.4 | Socket field | 9 |
| 1.5 | LabStation (optional) | 9 |
| 2 | Safety | 10 |
| 2.1 | Safety information | 10 |
| 2.1.1 | Safety information in the operating manual | 10 |
| 2.1.2 | Safety signs on the meter | 10 |
| 2.1.3 | Further documents providing safety information | 10 |
| 2.2 | Safe operation | 11 |
| 2.2.1 | Authorized use | 11 |
| 2.2.2 | Requirements for safe operation | 11 |
| 2.2.3 | Unauthorized use | 11 |
| 3 | Commissioning | 12 |
| 3.1 | Scope of delivery | 12 |
| 3.2 | Power supply | 12 |
| 3.2.1 | General information | 12 |
| 3.2.2 | Inserting/exchanging the batteries | 13 |
| 3.3 | Initial commissioning | 14 |
| 4 | Operation | 15 |
| 4.1 | Switching on the meter | 15 |
| 4.2 | Inserting a cell | 16 |
| 4.3 | General operating principles | 18 |
| 4.3.1 | Operating modes | 18 |
| 4.3.2 | Navigation | 19 |
| 4.3.3 | Navigation example 1: Setting the language | 20 |
| 4.3.4 | Example 2 on navigation: Setting the date and time | 22 |
| 4.3.5 | Menu overview | 24 |
| 4.4 | System settings (<i>System</i> menu) | 26 |
| 4.4.1 | <i>Measured value memory</i> | 27 |
| 4.4.2 | <i>Display</i> | 28 |
| 4.4.3 | <i>Interface</i> | 29 |
| 4.4.4 | <i>Date/time</i> | 29 |
| 4.5 | Photometry | 30 |
| 4.5.1 | General information | 30 |
| 4.5.2 | Settings for photometric measurements | 31 |
| 4.5.3 | Measuring the concentration | 32 |
| 4.5.4 | Blank value (reagent blank value) | 34 |
| 4.5.5 | Standard adjustment (user calibration) | 36 |
| 4.5.6 | Absorbance / % Transmission, measuring | 39 |
| 4.5.7 | Zero adjustment | 40 |

| | | |
|----------|---|-----------|
| 4.5.8 | Programs | 41 |
| 4.5.9 | <i>Analysis timer</i> | 42 |
| 4.5.10 | <i>Timer</i> | 42 |
| 4.5.11 | Measuring diluted samples | 43 |
| 4.6 | Data memory | 44 |
| 4.6.1 | Storing measurement datasets | 45 |
| 4.6.2 | Filtering measurement datasets | 46 |
| 4.6.3 | Displaying measurement datasets | 47 |
| 4.6.4 | Download the measurement datasets to the RS232 interface | 47 |
| 4.6.5 | Erasing stored measurement datasets | 48 |
| 4.7 | Transmitting data | 48 |
| 4.7.1 | Establishing the connection to a PC | 48 |
| 4.7.2 | Data transmission with the PC software LS Data | 49 |
| 4.7.3 | Data transmission with the Excel add-in MultiLab® Importer | 49 |
| 4.7.4 | Establishing the connection to a printer | 50 |
| 4.7.5 | Configuration for the data transmission to a terminal program | 51 |
| 4.7.6 | Transmitting data to a printer or terminal program | 52 |
| 4.7.7 | Examples of data transmitted (printer, terminal program) | 52 |
| 4.8 | Reset | 54 |
| 4.8.1 | Resetting the system settings | 54 |
| 4.8.2 | Resetting the photometry settings | 54 |
| 4.9 | Meter information | 55 |
| 4.10 | Software update | 55 |
| 4.11 | Administrating user-defined methods | 56 |
| 4.11.1 | Options for method administration | 56 |
| 4.11.2 | Administrating user-defined programs with a terminal program | 57 |
| 5 | Maintenance, cleaning, disposal | 60 |
| 5.1 | Maintenance | 60 |
| 5.1.1 | Inserting/exchanging the batteries | 60 |
| 5.1.2 | Retrofitting the battery pack | 61 |
| 5.2 | Cleaning | 62 |
| 5.2.1 | Cleaning the cell shaft | 62 |
| 5.2.2 | Cleaning the cells | 63 |
| 5.3 | Packing | 63 |
| 5.4 | Disposal | 63 |
| 6 | What to do if... | 64 |
| 6.1 | General errors | 64 |
| 6.2 | Photometry | 65 |
| 7 | Technical data | 66 |
| 7.1 | General data | 66 |

| | | |
|-----------|--------------------------------|-----------|
| 7.1.1 | pHotoFlex® STD | 66 |
| 7.2 | Photometry | 67 |
| 8 | Accessories and options | 69 |
| 8.1 | Accessories | 69 |
| 8.1.1 | Meter accessories | 69 |
| 8.1.2 | Connection cable: | 69 |
| 8.2 | Bar code reader | 71 |
| 9 | Firmware update | 72 |
| 10 | Disposal | 74 |
| 11 | Lists | 75 |
| 12 | Index | 77 |

1 Overview

1.1 General features

The compact pHotoFlex® STD handheld precision meter enables you to carry out the following measurements quickly and reliably:

- Concentration measurements (colorimetric measurements)
- Absorbance measurements
- Transmission measurements

The pHotoFlex® STD handheld meter provides the maximum degree of ease of use, reliability and measuring certainty for all applications.

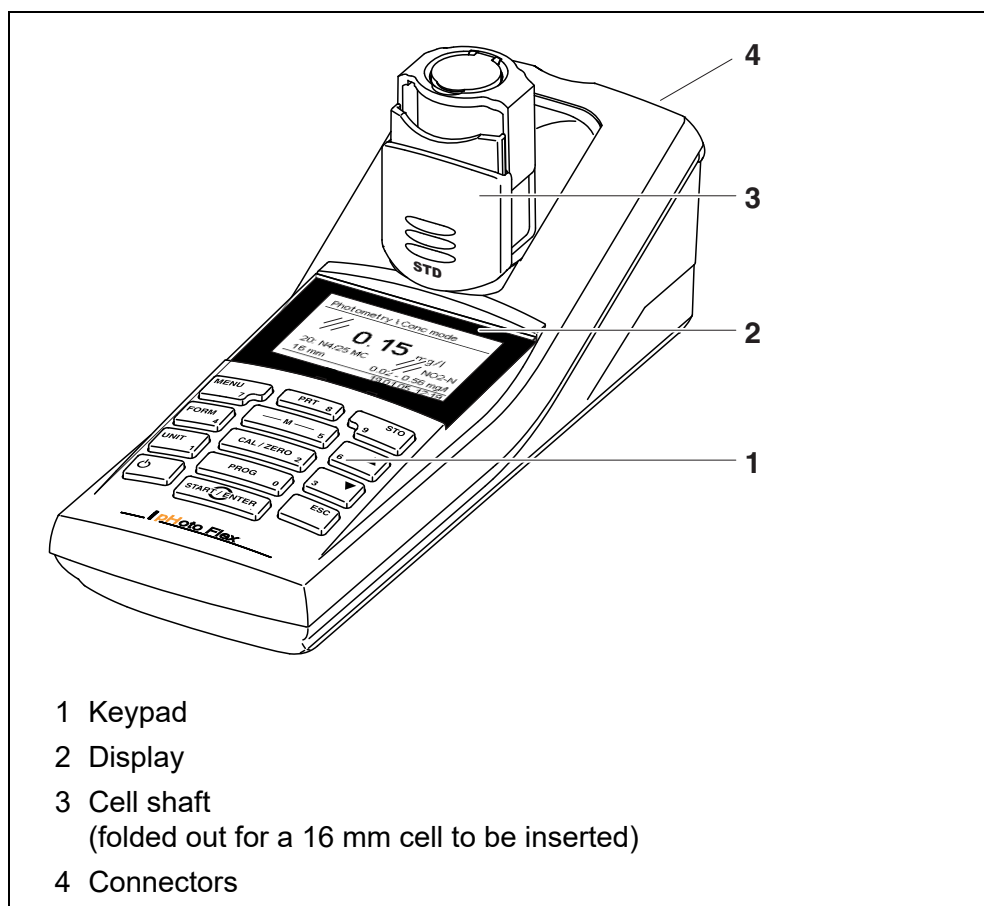

- 1 Keypad
- 2 Display
- 3 Cell shaft
(folded out for a 16 mm cell to be inserted)
- 4 Connectors



If you need further information or application notes, you can obtain the following material from WTW:







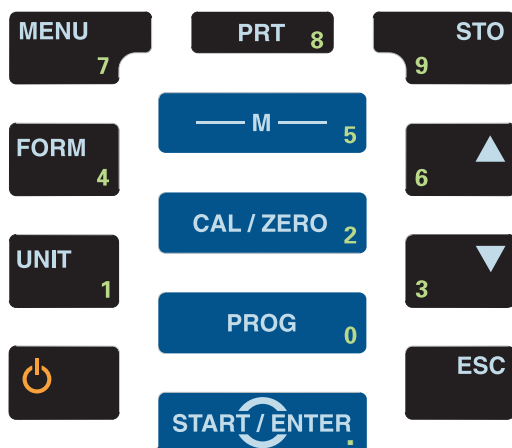

- Application reports
- Primers
- Safety datasheets.





You will find information on available literature in the WTW catalog or on the Internet.

1.2 Keypad



Key functions

| | |
|---|--|
|  | Select the measured variable <M> : – Concentration – Absorbance – % Transmission |
|  | Open the menu for adjustment measurements (blank values, zero adjustment) <CAL/ZERO> |
|  | Select a program for concentration measurement <PROG> |
|  | Open menus / confirm entries / start measurement <START/ENTER> |
|  | Call up the <i>Configuration</i> menu (all settings are made here) <MENU> |
|  | Switch over between available citation forms <FORM> |
|  | Switch over between available units <UNIT> |
|  | Switch the meter on or off <ON/OFF> |

| | |
|---|---|
|  | Output the display contents to the RS232 interface (e.g. print) <PRT> |
|  | Open the <i>Store</i> menu: <STO> Quick storing: 2 x <STO> |
|  | Highlight menu items or selection Set values <▲>, <▼> |
|  | Switch to the next higher menu level / cancel input <ESC> |



Keys with an additional number printed on are assigned doubly. This enables to directly enter numbers in special menus. Thus, you can, for example, conveniently enter the date and time via the number keys.

1.3 Display

The graphic display shows all information of the current measurement in the measured value display. The illumination enables to read the display even in the dark.

Example

| | |
|---|--|
| Photometry \ Concentration | ← Measuring mode \ measured parameter |
| 1.29 mg/l | ← Measured value (with unit) |
| 83: A6/25 MC NH4-N | ← Program and citation form |
| 16 mm 0.20 - 8.00 mg/l | ← Diameter of the cell and measuring range |
| 01.02.05 15:12 | ← Status line with date and time |

1.4 Socket field

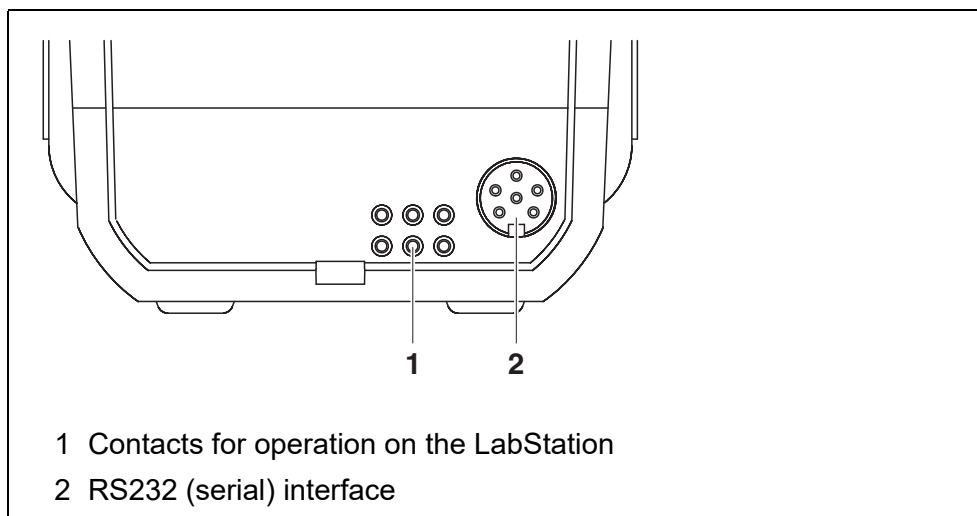

1.5 LabStation (optional)

The LabStation, which is available as an accessory, enables you to use the pHotoFlex® STD conveniently in the laboratory (see LabStation operating manual).

Laboratory operation with the LabStation enables the following additional functions:

- With photometric measurements, the zero measurement is retained even after switching the pHotoFlex® STD off and on again
- You can connect a barcode reader for the simplified calling up of programs
- The LSdata software included serves to easily enter user-defined programs
- Operation with power pack and battery pack (included in the scope of delivery of the LabStation). The battery pack in the pHotoFlex® STD is automatically charged as soon as the meter is placed in the LabStation.

2 Safety

2.1 Safety information

2.1.1 Safety information in the operating manual

This operating manual provides important information on the safe operation of the meter. Read this operating manual thoroughly and make yourself familiar with the meter before putting it into operation or working with it. The operating manual must be kept in the vicinity of the meter so you can always find the information you need.

Important safety instructions are highlighted in this operating manual. They are indicated by the warning symbol (triangle) in the left column. The signal word (e.g. "CAUTION") indicates the level of danger:



WARNING

indicates a possibly dangerous situation that can lead to serious (irreversible) injury or death if the safety instruction is not followed.



CAUTION

indicates a possibly dangerous situation that can lead to slight (reversible) injury if the safety instruction is not followed.

NOTE

indicates a possibly dangerous situation where goods might be damaged if the actions mentioned are not taken.

2.1.2 Safety signs on the meter

Note all labels, information signs and safety symbols on the meter and in the battery compartment. A warning symbol (triangle) without text refers to safety information in this operating manual.

2.1.3 Further documents providing safety information

The following documents provide additional information, which you should observe for your safety when working with the measuring system:

- Operating manuals of further accessories
- Safety datasheets of the test reagents for working with photometric test sets.

2.2 Safe operation



CAUTION

Danger of eye damage by visible and invisible LED radiation. In the cell shaft of the pHotoFlex® STD there are light emitting diodes (LEDs) of the 1M class.

Do not look at the radiation using optical instruments. With normal, authorized use there is no hazard.

2.2.1 Authorized use

This meter is authorized exclusively for carrying out the following measurements in the laboratory:

- Analysis of substances in water and aqueous solutions using round cells
- Concentration measurement
- Absorbance and transmission measurement

Only the operation and running of the meter according to the instructions and technical specifications given in this operating manual is authorized (see chapter 7 TECHNICAL DATA).

Any other use is considered unauthorized.

2.2.2 Requirements for safe operation

Note the following points for safe operation:

- The meter may only be operated according to the authorized use specified above.
- The meter may only be supplied with power by the energy sources mentioned in this operating manual.
- The meter may only be operated under the environmental conditions mentioned in this operating manual.
- The meter may only be opened if this is explicitly described in this operating manual (example: Inserting the batteries).

2.2.3 Unauthorized use

The meter must not be put into operation if:

- it is visibly damaged (e.g. after being transported)
- it was stored under adverse conditions for a lengthy period of time (storing conditions, see chapter 7 TECHNICAL DATA).

3 Commissioning

3.1 Scope of delivery

- Handheld meter, pHotoFlex® STD
- 4 batteries 1.5 V type AA
- 1 empty cell 16 mm
- 2 empty cells 28 mm
- Microfiber cloth to clean the meter
- Compact operating manual
- Overview of the keys / available programs
- CD-ROM with
 - Detailed operating manual
 - Photometry analysis manual with analysis specifications
 - Software to program user-defined methods
- Optional: LabStation with LSdata PC software, battery pack and universal power pack



The optional parts of the scope of delivery are available as accessories (see section 8.1).

3.2 Power supply

3.2.1 General information

The meter is supplied with power by 4 batteries 1.5 V type AA (see section 3.2.2).

When you are using the LabStation, you can also supply the meter with power with an battery pack. The battery pack is included in the scope of delivery of the LabStation and is inserted in the battery compartment instead of the batteries (see LabStation operating manual).

Automatic switch-off function

The meter has an automatic switch-off function in order to save the batteries or battery pack (see section 4.4).

Display illumination

During operation with the batteries or battery pack the meter automatically switches off the display illumination if no key is pressed for 30 seconds. The illumination is switched on again with the next keystroke. The display illumination can also be switched off completely (see section 4.4.2).

The *LoBat* display indicator appears when the batteries or battery pack are nearly discharged.

3.2.2 Inserting/exchanging the batteries

NOTE

Make sure that the poles of the batteries are positioned correctly. The \pm signs on the batteries must correspond to the \pm signs in the battery compartment.

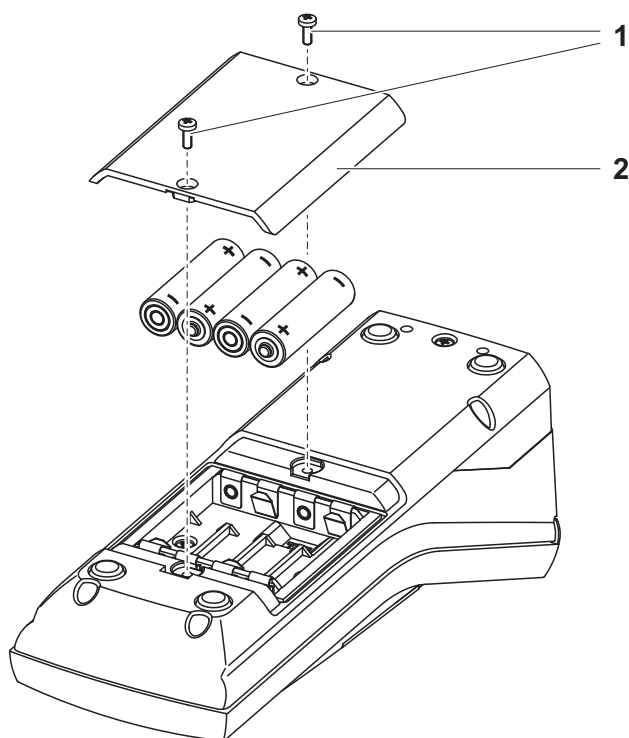

- 1 Open the battery compartment:
 - Unscrew the two screws (1) on the underside of the meter,
 - Remove the lid of the battery compartment (2).
- 2 If necessary, take four old batteries out of the battery compartment.
- 3 Insert four batteries (3) in the battery compartment.
- 4 Close the battery compartment and fix it with the screws.

3.3 Initial commissioning

Perform the following activities:

- For
 - Battery operation: Insert the batteries (see section 3.2.2)
 - Operation with LabStation and battery pack: Insert the battery pack, connect the LabStation and insert the meter in the LabStation (see LabStation operating manual)
- Switch on the meter (see section 4.1)
- Set the language as necessary (see section 4.3.3)
- Set the date and time as necessary (see section 4.3.4)



When you set the language, date and time according to the mentioned sections of this operating manual you will quickly become familiar with the simple operation of the pHotoFlex® STD.

4 Operation

4.1 Switching on the meter

Switching on

Press the <ON/OFF> key.

The *Start* menu appears for 30 seconds. The status line indicates the meter designation and the version number of the software.

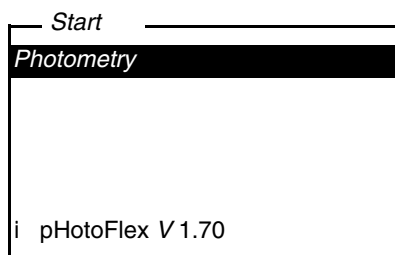

After a few seconds the meter automatically switches to the measured parameter used last.

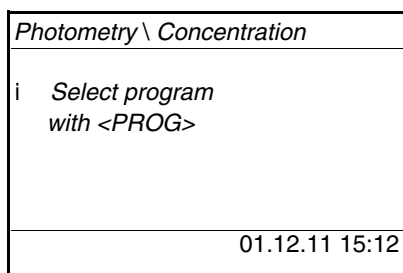

Using <M>, switch between the measured parameters *Concentration*, *Absorbance* and *% Transmission*.

Switching off

Press the <ON/OFF> key.

Automatic switch-off function

The meter has an automatic switch-off function in order to save the batteries or battery pack (see section 4.4). The automatic switchoff switches off the meter if no key is pressed for an adjustable period.

The automatic switchoff function is not active

- if the power is supplied by the LabStation (optional),
- if the *Timer* or *Analysis timer* function is on.

Display illumination with battery-powered operation

During operation with batteries or battery pack the meter automatically switches off the display illumination if no key is pressed for 30 seconds. The illumination is switched on again with the next keystroke.

4.2 Inserting a cell

To be able to insert cells in the pHotoFlex® STD, the cell shaft has to be prepared to take in a cell.

- 1 Push the dust cover (1) upward.
The cell shaft for 28 mm cells is open.
 - Insert a 28 mm cell (see below)
 - Insert a 16 mm cell (see page 17)

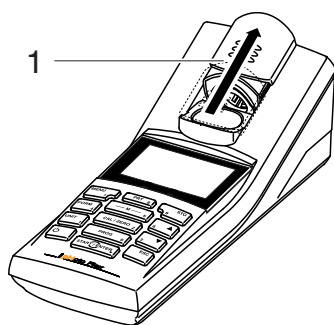
**Inserting a 28 mm cell**

- 2 Insert the cell so that it is positioned on the bottom of the cell shaft.
The cell is ready to be measured.



Inserting a 16 mm cell

- 1 Put the fold-out cell shaft (2) in an upright position until it locks into place.

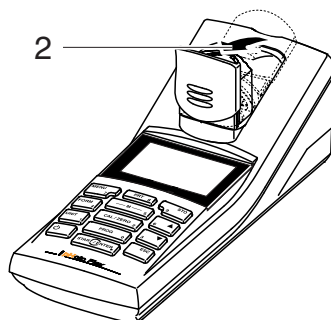

- 2 Pull upwards the height adapter (3). The cell shaft is extended.

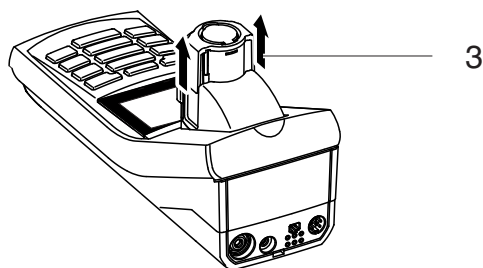

- 3 Open the external light cover (4) of the cell shaft.

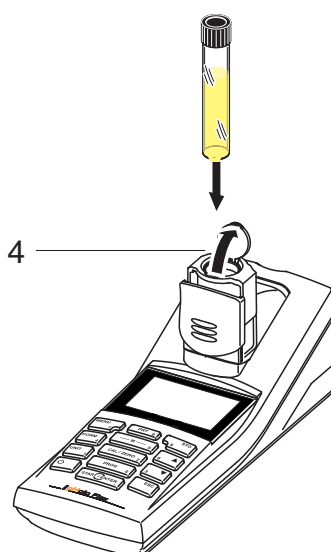

- 4 Insert the 16 mm cell (marking points to the front) so that it is positioned on the bottom of the cell shaft.
- 5 Close the external light cover (4).
The cell is ready to be measured.



For optimum measurement results, the cell must always be covered by the external light cover. Otherwise, the external light can falsify the measurement result.

4.3 General operating principles

This section contains basic information on the operation of the pHotoFlex® STD.

Operating elements, display

An overview of the operating elements and the display is given in section 1.2 and section 1.3.

Operating modes, navigation

An overview of the operating modes of the pHotoFlex® STD and the navigation through menus and functions can be found in section 4.3.1 and section 4.3.2.

4.3.1 Operating modes

The instrument has the following operating modes:

- Measuring
The meter determines measurement data and displays the results in the measured value display
- Calibrating
The meter carries out a blank value measurement or zero adjustment
- Data transmission
The meter transmits datasets to the serial interface
- Configuration
The display indicates a menu with further menus, settings and functions

4.3.2 Navigation

Measured value display

In the measured value display, you can

- select the measured parameter with **<M>**:
 - *Concentration*
 - *Absorbance*
 - *% Transmission*
- open the menu with **<MENU>**
- switch to the superordinate *Start* menu with **<ESC>**.

Menus and dialogs

The menus for settings and dialogs in procedures contain further subelements. The selection is done with the keys **<▲>** **<▼>**. The current selection is displayed inverse.

- Menus
The name of the menu is displayed at the upper edge of the frame. Menus are opened by confirming with **<START/ENTER>**. Example:

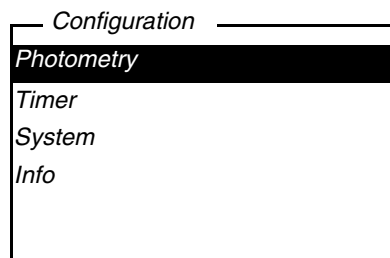

- Settings
Settings are indicated by a colon. The current setting is displayed on the right-hand side. With **<START/ENTER>**, the selection of the possible settings is opened. Subsequently, the setting can be changed with **<▲>** **<▼>** and **<START/ENTER>**.
Example:

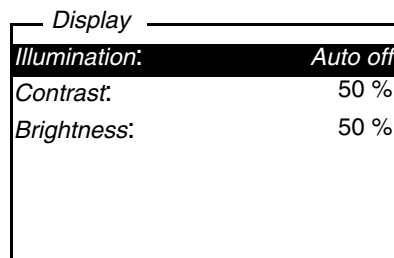

- Functions
Functions are designated by the name of the function. They are immediately carried out by confirming with **<START/ENTER>**.
Example:

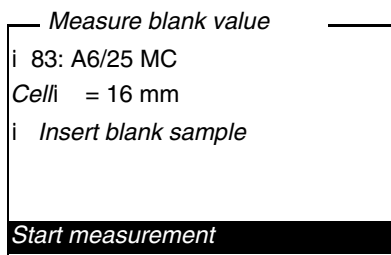

- Messages
 Information or operating instructions are designated by the i symbol. They cannot be selected.

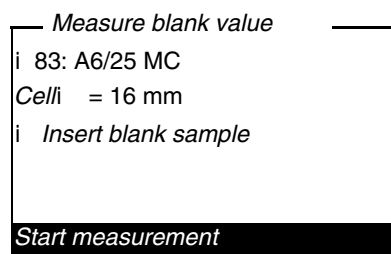

The principles of navigation are explained in the two following sections by reference of examples:

- Setting the language (section 4.3.3)
- Setting the date and time (see section 4.3.4).

4.3.3 Navigation example 1: Setting the language

The following example describes in the language of the country how to set the language. On delivery, English is set as the language in the pHotoFlex® STD. During initial commissioning, the language setting is done in the menu, *Configuration / System / Language*.

- 1 In the measured value display:
 Using <MENU>, open the *Configuration* menu.
 The instrument is in the configuration mode.
- 2 Select the *System* menu with <▲> <▼>.
 The current selection is displayed in reverse video.
- 3 Using <START/ENTER>, open the *System* menu.

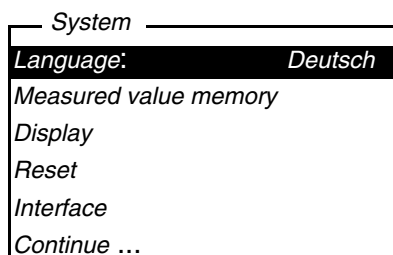

- 4 Select the *Language* menu with <▲> <▼>.
The current selection is displayed in reverse video.
- 5 Open the setting of the *Language* with <START/ENTER>.

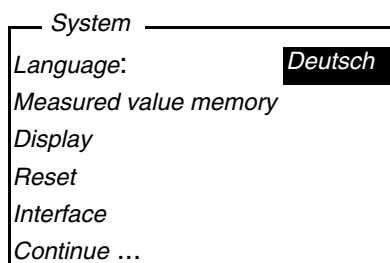

- 6 Select the required language with <▲> <▼>.
- 7 Confirm the setting with <START/ENTER>.
The setting is active. The menu is displayed in the selected language.
- 8 To make further settings, switch to the next higher menu level with <ESC>.
or
Switch to the measured value display with <M> (short pressure).
The instrument is in the measuring mode.

4.3.4 Example 2 on navigation: Setting the date and time

The meter has a clock with a date function. The date and time are indicated in the status line of the measured value display. When storing measured values and calibrating, the current date and time are automatically stored as well.

Numerals are generally entered via the number keys.

The correct setting of the date and time and date format is important for the following functions and displays:

- Current date and time
- Calibration date
- Identification of stored measured values.

Therefore, check the time at regular intervals.



After a fall of the supply voltage (empty batteries, empty battery pack), the date and time are reset to 01.01.2003 00, 00:00 hours.

Setting the date, time and date format

The date format can be switched from the display of day, month, year (*dd.mm.yy*) to the display of month, day, year (*mm/dd/yy* or *mm.dd.yy*).

- 1 In the measured value display:
Using **<MENU>**, open the *Configuration* menu.
The instrument is in the configuration mode.
- 2 Using **<▲>** **<▼>** and **<START/ENTER>**, select and confirm the menu *System / Continue ... / Date/time*.

| <i>Date/time</i> | |
|---------------------|-----------------|
| <i>Time:</i> | 14:53:40 |
| <i>Date:</i> | 01.02.05 |
| <i>Date format:</i> | <i>dd.mm.yy</i> |

- 3 Select and confirm the *Time* menu with **<▲>** **<▼>** and **<START/ENTER>**.
A display for the entry of numerals with the number keys opens up.

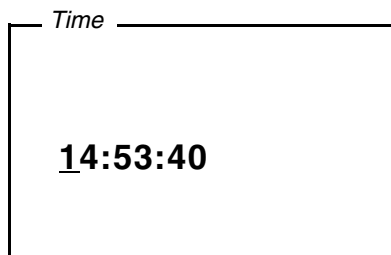

- 4 Enter the time using the number keys.
The digit to be changed is displayed underlined.



In the case of wrong entries, you can cancel the procedure with **<ESC>**.

After canceling with **<ESC>**, it is possible to enter all digits once again. The new digits are only taken over by confirming with **<START/ENTER>**.

- 5 Confirm the setting with **<START/ENTER>**.
The time is set.
- 6 Set the current *Date* as necessary. The setting is made similarly to that of the time.
- 7 Change the date format as necessary.
- 8 To make further settings, switch to the next higher menu level with **<ESC>**.
or
Switch to the measured value display with **<M>**.
The instrument is in the measuring mode.

4.3.5 Menu overview

| | | | | |
|-------------------|------------------------------|---|--|--|
| <i>Photometry</i> | <i>Meas. param.</i> | <i>Concentration</i> <i>% Transmission</i> <i>Absorbance</i> | | |
| | <i>Programs</i> | | | |
| | <i>Dilution</i> | | | |
| | <i>Analysis timer</i> | <i>On</i> <i>Off</i> | | |
| | <i>Reset</i> | | | |
| <i>Timer</i> | | | | |
| <i>System</i> | <i>Language</i> | <i>Deutsch</i> <i>English</i> <i>Français</i> <i>Español</i> | | |
| | <i>Measured value memory</i> | <i>Display</i> | | |
| | | <i>RS232 download</i> | | |
| | | <i>Data filter</i> | <i>Filter ID</i> <i>PROG</i> <i>Date</i> | |
| | | <i>Delete</i> | | |
| | | <i>i 4 of 1000 i occupied</i> | | |
| | | <i>i Filter. No filter</i> | | |
| | <i>Display</i> | <i>Illumination</i> | <i>Auto off</i> <i>On</i> <i>Off</i> | |
| | | <i>Contrast</i> | 0 ... 100 % | |
| | | <i>Brightness</i> | 0 ... 100 % | |
| <i>Reset</i> | | | | |

(continued on next page)

| | | | |
|--|--|----------------------|---|
| <i>System</i> (continued) | <i>Interface</i> | <i>Baud rate</i> | 1200 2400 4800 9600 19200 |
| | | <i>Output format</i> | <i>ASCII</i> <i>CSV</i> |
| | <i>Continue ... / Date/time</i> | <i>Time</i> | hh:mm:ss |
| | | <i>Date</i> | |
| | | <i>Date format</i> | <i>dd.mm.yy</i> <i>mm.dd.yy</i> <i>mm/dd/yy</i> |
| <i>Continue ... / Switchoff time</i> | 10, 20, 30, 40, 50 min, 1, 2, 3, 4, 5, 10, 15, 20, 24 h | | |
| <i>Continue ... / Beep</i> | <i>On</i> <i>Off</i> | | |

Info

4.4 System settings (*System* menu)

The following instrument features and general functions can be found in the *Configuration / System* menu:

- Language selection (*Language*)
- Memory and database functions (*Store*)
- Display settings (*Display*)
- Restore basic settings (*Reset*)
- Configuration of the interface for PC/printer (*Interface*)
- Setting the date/time (*Date/time*)
- Setting the switch-off time (*Switchoff time*)
- Setting the keyboard sound (*Beep*)

Settings/functions

The settings are in the menu, *Configuration / System*. Move to the *Configuration* menu with the <MENU> key.

| Menu item | Setting | Explanation |
|---------------------------------|---|--|
| <i>Language</i> | <i>Deutsch</i> <i>English</i> <i>Français</i> <i>Español</i> | Select the language (see section 4.3.3) |
| <i>Measured value memory</i> | <i>Display</i> <i>RS232 down-load</i> <i>Data filter</i> <i>Delete</i> | Memory and database functions (see section 4.6.2) |
| <i>Display</i> | <i>Illumination</i> <i>Contrast</i> <i>Brightness</i> | Switch on/off the display illumination (see section 4.4.2) |
| <i>Reset</i> | - | Resets all system settings to default (see section 4.8.1) |
| <i>Interface</i> | <i>Baud rate</i> <i>Output format</i> | Baud rate of the data interface (see section 4.4.3) |
| <i>Continue ... / Date/time</i> | <i>Time</i> <i>Date</i> <i>Date format</i> | Settings of time and date (see section 4.3.4) |

| Menu item | Setting | Explanation |
|--|--|---|
| <i>Continue ... / Switchoff time</i> | 10, 20, 30, 40, 50 min, 1, 2, 3, 4, 5, 10, 15, 20, 24 h | The automatic switchoff function switches the meter off if no entry is made for a specified period of time (<i>Switchoff time</i>). This saves the batteries or battery pack. |
| <i>Continue ... / Beep</i> | <i>On</i> <i>Off</i> | Switches on/off the beep on keystroke |

4.4.1 Measured value memory

In the *Measured value memory* menu, you find functions to display and edit the stored measurement datasets:

- Display the measurement datasets on the screen (*Display*)
- Download the measurement datasets to the RS232 interface (*RS232 download*)
- Set up filter rules for the stored measurement datasets (*Data filter*)
- Erase all stored measurement datasets (*Delete*)
- Information on the number of occupied memory locations

The settings are in the menu, *Configuration / System / Measured value memory*. Move to the *Configuration* menu with the <MENU> key.

Settings/functions

| Menu item | Setting/function | Explanation |
|----------------|------------------|---|
| <i>Display</i> | - | Displays in pages all measurement datasets that correspond to the filter settings. Further options: <ul style="list-style-type: none"> ● Scroll through the datasets with <▲> <▼>. ● Output the displayed dataset to the interface with <PRT>. ● Quit the display with <ESC>. |

| Menu item | Setting/function | Explanation |
|-----------------------|-------------------|---|
| <i>RS232 download</i> | - | Downloads to the interface all measurement datasets that correspond to the filter settings. The download is ordered according to the date and time. The process can take several minutes. To terminate the process prematurely, press <ESC>. |
| <i>Data filter</i> | see section 4.6.2 | Allows to set filter criteria in order to display and download datasets to the interface. |
| <i>Delete</i> | - | Erases the entire contents of the measuring data memory, independent of the filter settings. Note: All calibration data remain stored when this action is performed. |

All details on the subjects of memory and stored data is given in section 4.6.2.

4.4.2 Display

In the *Configuration / System / Display* menu, you set the display features:

- Switching on/off the display illumination (*Illumination*)
- Display contrast (*Contrast*)

The settings are in the menu, *Configuration / System / Display*. Move to the *Configuration* menu with the <MENU> key.

Settings

| Menu item | Setting | Explanation |
|---------------------|-------------------------|---|
| <i>Illumination</i> | <i>Auto off</i> | The display illumination is automatically switched off if no key has been pressed for 30 seconds. |
| | <i>On</i> <i>Off</i> | Switches the display illumination on or off permanently (see section 4.5.9) |

| Menu item | Setting | Explanation |
|-------------------|-------------|--------------------------------|
| <i>Contrast</i> | 0 ... 100 % | Changes the display contrast |
| <i>Brightness</i> | 0 ... 100 % | Changes the display brightness |

4.4.3 Interface

In the *Interface* menu, you set the features of the interface:

- Transmission speed (*Baud rate*)
- Output format (*Output format*)

The settings are in the menu, *Configuration / System / Interface*. Move to the *Configuration* menu with the <MENU> key.

Settings

| Menu item | Setting | Explanation |
|----------------------|-------------------------------------|---|
| <i>Baud rate</i> | 1200, 2400, 4800, 9600, 19200 | Baud rate of the data interface |
| <i>Output format</i> | ASCII CSV | Output format for data transmission For details, see section 4.7 |

4.4.4 Date/time

In the *Configuration / System / Continue / Date/time* menu, you set the system clock:

- Current time (*Time*)
- Current date (*Date*)
- Format of the date display (*Date format*)

The settings are in the menu, *Configuration / System / Continue / Date/time*. Move to the *Configuration* menu with the <MENU> key.

Settings

| Menu item | Setting | Explanation |
|-------------|----------|-------------------------------------|
| <i>Time</i> | hh:mm:ss | Enter the time with the number keys |
| <i>Date</i> | | Enter the date with the number keys |

| Menu item | Setting | Explanation |
|--------------------|---|----------------------------|
| <i>Date format</i> | <i>dd.mm.yy</i> <i>mm.dd.yy</i> <i>mm/dd/yy</i> | Settings of time and date. |

4.5 Photometry

4.5.1 General information

Photometric measurements serve to determine chemical substances in liquid samples. For this determination, the substance to be determined has to be present in a form that is suitable for photometric measurement. At the same time, possible disturbing factors have to be excluded.

Before measurement, the sample has to be pretreated in order to bring the substance to be determined into the form that is suitable for measurement and at the same time exclude disturbing factors.

Pretreatment of the sample is described in the analysis specification.

In a simple case, pretreatment can be to dissolve a solid substance in water; it can, however, also include chemical conversions, e. g. a digestion.

The chemicals required in the analysis specification are available as test sets.



Suitable analysis specifications for test sets can be found in the photometry analysis manual (on CD-ROM).

There you will also find further instructions on handling chemicals and on how to proceed when applying the analysis specifications.

Methods and the corresponding method data for many test sets are stored as programs in the pHotoFlex® STD. A program number is assigned to each program.

The stored method data are loaded when the program number is entered or read in with the aid of a bar code reader.

You can look up an overview of the available methods in the photometry analysis manual and display it on the screen of the pHotoFlex® STD (see section 4.5.8).

You can measure the following parameters with the pHotoFlex® STD:

- *Concentration*[mg/l]
- *% Transmission* []
- *Absorbance* []

Preparatory activities

Perform the following preparatory activities when you want to measure:

- 1 Clean the exterior of the cells before filling them with sample and also before measuring if necessary (see section 5.2.2).
- 2 For measurement, place the pHotoFlex® STD on a horizontal surface.

4.5.2 Settings for photometric measurements

For photometric measurements, the following settings are available in the *Configuration / Photometry* menu:

- Setting the measured parameter
- Displaying a list of all programs
- Setting the dilution factor
- Switching on or off the analysis timer
- Resetting the settings for photometric measurements

The settings are in the menu, *Configuration / Photometry*. Move to the *Configuration* menu with the <MENU> key.

Settings

| Menu item | Setting | Explanation |
|-----------------------|--|---|
| <i>Meas. param.</i> | <i>Concentration</i> <i>% Transmission</i> <i>Absorbance</i> | Measured parameter |
| <i>Programs</i> | | Display all programs with the corresponding program data (see section 4.5.8). |
| <i>Dilution</i> | | Set the dilution factor (see section 4.5.11) |
| <i>Analysis timer</i> | <i>On</i> <i>Off</i> | Switch on/off the analysis timer (see section 4.5.9) |
| <i>Reset</i> | | Reset all settings for photometric measurements (see section 4.9) |

4.5.3 Measuring the concentration

- 1 If necessary, press the <M> key several times until the measured parameter *Concentration* is selected.

First concentration measurement with the pHotoFlex® STD

| | |
|----------------------------|----------------------------|
| Photometry \ Concentration | |
| i | Select program with <PROG> |
| 01.12.11 15:12 | |

Second and all further concentration measurements

| | |
|----------------------------|--|
| Photometry \ Concentration | |
| i | Select program with <PROG> or with ▲ ▼ |
| 83: A6/25 MC | NH4-N |
| 16 mm | 0.20 - 8.00 mg/l |
| 01.12.11 15:12 | |



From the second concentration measurement, the data of the program last used is automatically displayed here. With <▲> <▼> you can quickly switch between the ten programs last used.

To select a program, you can as an alternative also read in the program number of an analysis specification with a bar code reader (see section 8.2). The following step three is skipped. You can directly start measuring.

The program number of the test is given in the analysis specification, in the list of available programs and, with some tests, on the packing of the test (under the bar code).

- 2 Open the *Program number* display with <PROG>, enter the required program number with the number keys and confirm with <START/ENTER>. or (from the second concentration measurement): Select a program out of the last ten programs with <▲> <▼>. The program data is displayed.



If a program number is selected that requires a measured blank value, the menu automatically guides to the blank value measurement.

| | |
|-----------------------------------|--------------------------------|
| <i>Photometry \ Concentration</i> | |
| i | Insert sample |
| i | Start measurement with <START> |
| 83: A6/25 MC | NH4-N |
| 16 mm | 0.20 - 8.00 mg/l |
| 01.12.11 15:12 | |

- 3 Insert the cell (see section 4.2).
- 4 Start the measurement with <START/ENTER>. Measurement is started. The result is displayed.

| | |
|-----------------------------------|------------------|
| <i>Photometry \ Concentration</i> | |
| | [BV] |
| 0.74 mg/l | |
| 83: A6/25 MC | NH4-N |
| 16 mm | 0.20 - 8.00 mg/l |
| 01.12.11 15:12 | |

← A blank value measured by the user is used

Display when the measuring range is exceeded or undercut

| Display | Meaning |
|--|--|
| "< [Lower limit of measuring range]" instead of the measured value | Measuring range undercut. <u>Remedy:</u> Select a test with a lower measuring range |
| "> [Upper limit of measuring range]" instead of the measured value | Measuring range exceeded. <u>Remedy:</u> Select a test with a higher measuring range or dilute the sample |
| Orientation value | This value serves as an indication for the selection of a suitable test or dilution. If an evaluation of the measurement signal is no longer possible (intensity too high or too low), four bars appear ("----"). |

Examples:

| | |
|----------------------------|------------------|
| Photometry \ Concentration | |
| 0.16 | [BV] |
| < 0.20 mg/l | |
| 83: A6/25 MC | NH4-N |
| 16 mm | 0.20 - 6.51 mg/l |
| 01.02.05 15:12 | |

Orientation value

| | |
|----------------------------|------------------|
| Photometry \ Concentration | |
| ---- | [BV] |
| < 0.20 mg/l | |
| 83: A6/25 MC | NH4-N |
| 16 mm | 0.20 - 6.51 mg/l |
| 01.02.05 15:12 | |

Measurement signal cannot be evaluated



The orientation value can be very inaccurate and should not be used as a measured value!

4.5.4 Blank value (reagent blank value)

A blank value is required for every concentration measurement. For some programs (methods) for concentration measurement, the blank values are already stored in the meter. They are used automatically. For all other programs, the blank value has to be determined separately before the first measurement.

Each stored reagent blank value can be replaced by a blank value determined by the user.



You will find more information on blank values in the photometry analysis manual. A table with the programs and required blank values is included in the analysis specifications.

A blank value is always stored for the program that has just been called up. It remains stored until it is erased (menu item, *Delete blank value*) or overwritten.

The *Reset* function erases all blank values measured by the user and restores the blank values stored in the factory.

If a blank value measured by the user is stored for a program, this blank value is used for measurement. The usage of the blank value measured by the user is documented and also indicated in the measured value display.

Blank value measurement

- 1 If necessary, press the <M> key several times until the measured parameter *Concentration* is selected.
- 2 Select a program with <PROG> as necessary.



The following measurement of the blank value applies only to the selected program.

- 3 Open the adjustment menu with <CAL/ZERO>.

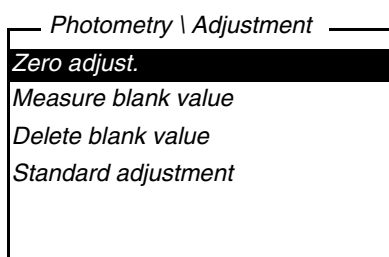

- 4 Using <▲> <▼> and <START/ENTER>, select and start the *Measure blank value* function.

The menu-guided blank value measurement begins.
Follow the instructions on the display.

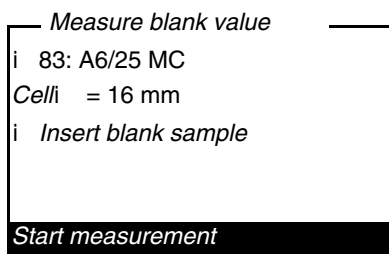

- 5 Insert a cell with blank sample (see section 4.2).
- 6 Start the measurement of the blank value with <START/ENTER>. After measuring, the result of the blank value measurement is displayed and stored. The result is displayed as *i Blank value measurement successful!* or *i Blank value measurement erroneous!*.

```

— Measure blank value
i 83: A6/25 MC
Celli = 16 mm
i Absorbance = 0.301
i Blank value mea-
surement
successful!

```

- 7 Confirm the result with **<START/ENTER>**.
The blank value measurement is completed.
The meter is ready to measure.
or:
Discard the result with **<ESC>**.
Subsequently, carry out a new blank value measurement.

4.5.5 Standard adjustment (user calibration)

With some of the programs (methods) for concentration measurement, you can optimize the calibration curve stored in the meter with the aid of the *Standard adjustment* function.

A standard adjustment is only valid if the deviation compared to the original calibration is no more than 30%.

A standard adjustment is always stored for the program that is presently called up. A standard adjustment is only deleted if

- a new standard adjustment is carried out
- the standard adjustment is erased manually
- the meter is reset to delivery status (*Reset* function)

Standard adjustment

- 1 If necessary, press the **<M>** key several times until the measured parameter *Concentration* is selected.
- 2 Select a program with **<PROG>** as necessary.



The following measurement of the standard applies only to the selected program.

- 3 Open the *Photometry \ Adjustment* menu with **<CAL/ZERO>**.

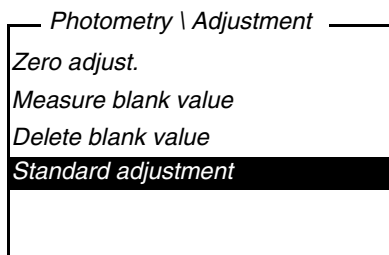

- 4 Open the *Standard adjustment* menu with <▲> <▼> and <START/ENTER>.



If data of a standard adjustment are already available, the data of the last standard adjustment are displayed. Here you can also erase the data of an active standard adjustment.

- 5 Using <▲> <▼> and <START/ENTER>, select and start the *Measure standard* function.

The menu-guided standard measurement begins.
Follow the instructions on the display.

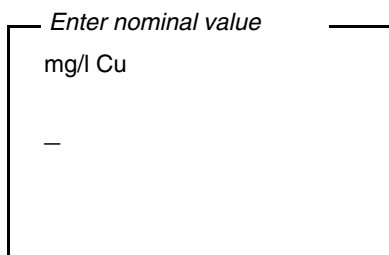

- 6 Enter the nominal value of the standard.

Note:

Enter the decimal separator with <START/ENTER>.

- 7 Confirm the entered nominal value with <START/ENTER>.

- 8 Insert a cell with standard (see section 4.2).

- 9 Start the measurement of the standard with <START/ENTER>.

After measuring, the result of the standard adjustment is displayed and stored.

As the result, the measured value and the adjustment (in %) or *Error* is displayed.

```
— Measure standard
i 304: Cu-1 TP
Celli = 10 mm
i 0.600 mg/l Cu:
  2.000 (93.2%)
Accept
```

- 10 Confirm the result with **<START/ENTER>**.

The standard adjustment is completed.
The meter is ready to measure.

or:

Discard the result with **<ESC>**.

Subsequently, carry out a new standard adjustment.



If a standard adjustment is stored for a program, the standard adjustment is automatically used for measurement. The usage of the standard adjustment is documented together with the measured value and indicated in the measured value display with [Cal].

4.5.6 Absorbance / % Transmission, measuring



The transmission measurement is not described separately in the following example as it operates in exactly the same way as the absorbance measurement. The result of the measurement is displayed in *% Transmission*.

- 1 Press the **<M>** several times as necessary until the measured parameter *Absorbance* (or *% Transmission*) is selected.

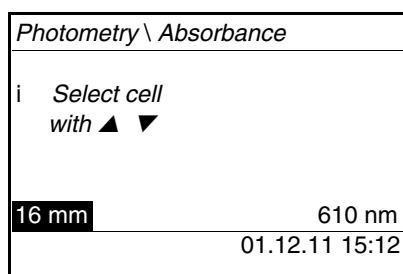

- 2 Select the cell diameter with **<▲>** **<▼>** and confirm with **<START/ENTER>**.
- 3 Select the wavelength with **<▲>** **<▼>** and confirm with **<START/ENTER>**.

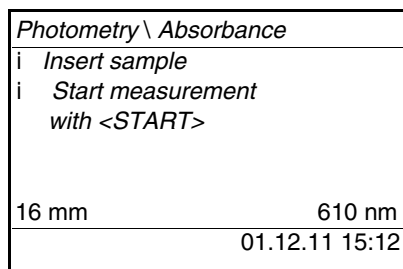

- 4 Clean the cell (see section 5.2.2).
- 5 Insert the cell (see section 4.2).
- 6 Start the measurement with **<START/ENTER>**.
The measurement result is displayed when the measurement is finished.

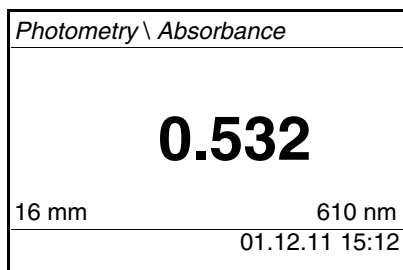

4.5.7 Zero adjustment

The zero adjustment, i. e. measuring and storing the absorbance of a cell filled with water, is necessary after the meter is switched on.

Additionally, we recommend to carry out a zero adjustment if the ambient temperature has changed.

Only perform the zero adjustment against distilled water in an optically perfect cell. The zero adjustment must be performed separately for each cell type.

- 1 If necessary, press the **<M>** key several times until the measured parameter *Concentration* is selected.
- 2 Press the **<CAL/ZERO>** key.

The menu for adjustment measurements opens up.

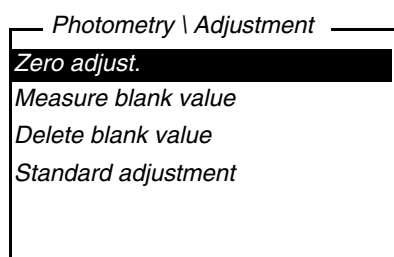

- 3 Using **<▲>** **<▼>** and **<START/ENTER>**, select and start the *Zero adjust.* function.

The menu-guided zero adjustment starts.
Follow the instructions on the display.

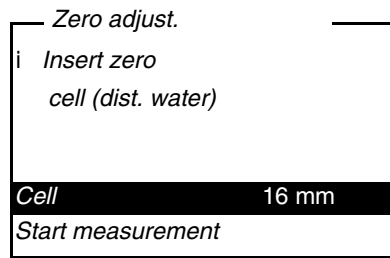

- 4 Insert the cell (see section 4.2).
- 5 Set another cell with <▲> <▼> and <START/ENTER> as necessary.
- 6 Start the measurement of the zero adjustment with <START/ENTER>.

After measuring, the result of the zero adjustment is displayed and stored.

i *Zero adjust. successful!* (successful zero adjustment) or i *Calibration error!* (zero adjustment not successful) is displayed as the result. The zero adjustment is completed.



If i *Calibration error!* was displayed as the calibration result, a note automatically reminds you of another zero adjustment before the next measurement.

Measuring is not possible without a valid zero adjustment.

- 7 Confirm the result with <START/ENTER>.
- The zero adjustment is completed.
The meter is ready to measure.

4.5.8 Programs

Displaying program data

You can view the most important data of all methods. The method data is ordered according to the program number.

- 1 Open the menu *Configuration/ Photometry/ Programs*.
The display shows the most important data of the selected program.

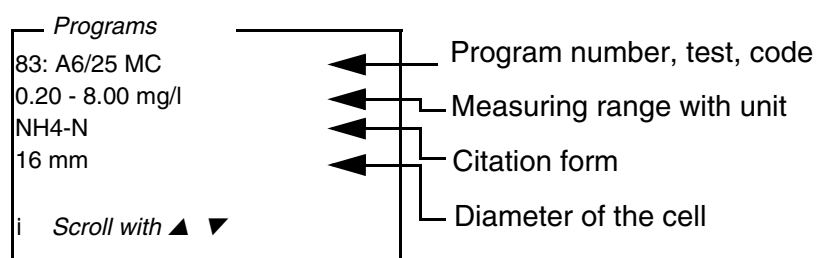



This data is also to be found in the photometry analysis manual in the overview of the test sets and in the individual analysis specifications for the test sets.

Updating programs

Go to www.xylyanalytics.com to always find the latest software version with the newest programs and method data for your pHotoFlex® STD (see section 9).

User-defined programs

User-defined programs (methods) can be stored under program numbers between 900 and 949. You can store up to 50 user-defined programs (see section 4.11).

4.5.9 Analysis timer

Measuring according to analysis instructions often means there are waiting periods between the individual steps.

These waiting periods (time intervals) are stored in the instrument with the program data for each program. The active *Analysis timer* function automatically reminds you to observe these time intervals by means of the menu guidance.

If you want to manually enter time intervals, use the *Timer* function (see section 4.5.10).

The *Analysis timer* with the required time interval is automatically displayed at the due point.

Start the *Analysis timer* with the **<START/ENTER>** key.

Shortening the time interval is not possible.

An acoustic signal sounds when the adjusted time interval has expired.

The *Analysis timer* function is switched on or off in the *Configuration / Photometry/Analysis timer* menu.

This setting generally applies to all measurements with methods according to analysis specification.

4.5.10 Timer

When measuring according to analysis specifications, waiting periods often have to be kept between individual steps of the method.

With the *Timer* function you manually set a time interval.

If you want to be automatically reminded of the given time intervals, use the *Analysis timer* function (see section 4.5.9).

The timer is displayed in the measured value display. It always displays the remaining time of the adjusted time interval.

When the adjusted time interval has expired, the timer indicates 00:00:00,

and an acoustic signal sounds.

The *Timer* function is started in the *Configuration / Timer* menu by entering a time interval.

4.5.11 Measuring diluted samples

If the concentration of a test sample exceeds the measuring range of a method, you can dilute the sample by a factor 1 ... 99 so that the concentration of the diluted test sample is within the measuring range of the method (see photometry analysis manual). Thus a valid measurement is possible.

After entering the factor for the dilution the meter converts the concentration to that of the undiluted sample.

The display then indicates the measured value of the undiluted sample.

Entering the factor of the dilution

- 1 Select the program for which a dilution factor is to be entered.
- 2 Open the menu *Configuration/ Photometry / Dilution*.
The current factor of the dilution is displayed.



- 3 Open the display for the entry of numerals with **<START/ENTER>**.
- 4 Enter the factor of the dilution with the number keys.
The factor has to be a whole number between 0 ... 99.
- 5 Confirm the factor with **<START/ENTER>**.
- 6 Exit the *Dilution* menu with **<ESC>**.
For the following measurements with the selected program, the concentration of the undiluted sampled is displayed as the measurement result.

The entered dilution factor is only valid for the selected program. The dilution factor is erased if

- the photometer is switched off
- a different program number is selected
- the factor 0 is entered in the *Dilution* menu.

If a dilution factor is active, it is indicated on the display during measurement in the form $[x + 1]$.

4.6 Data memory

The meter has 100 storage locations for measurement datasets.

You can transmit measured values (datasets) to the data memory with the **<STO>** key.

Each data storage process transmits the current dataset to the interface at the same time.

The number of memory locations that are still free is displayed in the *Store* menu. The number of memory locations that are occupied is displayed in the *System \ Measured value memory* menu.

Measurement dataset

A complete dataset consists of:

- Date/time
- ID number (ID)
- Program number
- Measured value
- Citation form
- Use of a blank value (BV)
- Dilution (x + 1)

4.6.1 Storing measurement datasets

Proceed as follows to transmit to the data memory and simultaneously output to the interface a measurement dataset:

- 1 Press the **<STO>** key.
The *Store* display appears.

```
Store (996 free)
i 01.12.2011 15:10:11
  PROG 86
  1.12 mg/l NH4-N
  [BV]
assign ID: 1
Store (ID: 1:
```

- 2 Using **<▲>** **<▼>**, **<START/ENTER>** and the number keys, change and confirm the ID number (*ID*) as necessary (0 ... 999).
- 3 Using **<START/ENTER>** or **<STO>**, confirm *Store*.
The dataset is stored. The meter switches to the measured value display.



A measurement dataset is quickly stored by twice pressing **<STO>**. It is stored with the ID set last.

If the memory is full

You can erase the entire memory (see section 4.6.5), or overwrite the oldest dataset with the next storing procedure.
A security prompt appears before a dataset is overwritten.

4.6.2 Filtering measurement datasets

The functions to display and download stored measurement datasets (see section 4.4.1) refer to all stored measurement datasets that correspond to the specified filter criteria.

The settings are in the menu, *Configuration / System / Measured value memory / Data filter*.

Move to the *Configuration* menu with the <MENU> key.

| Data filter | Menu item | Setting/function | Explanation |
|-------------|---------------|-------------------------|---|
| | <i>Filter</i> | | Filter criteria: |
| | | <i>No filter</i> | Data filter switched off |
| | | <i>ID</i> | Selection according to ID number |
| | | <i>PROG</i> | Selection according to program |
| | | <i>Date</i> | Selection according to period |
| | | <i>ID + PROG</i> | Selection according to program and ID number |
| | | <i>ID + Date</i> | Selection according to period and ID number |
| | | <i>PROG + Date</i> | Selection according to program and date |
| | | <i>ID + PROG + Date</i> | Selection according to ID, program and date |
| | <i>ID</i> | | Entry of filter criteria |
| | <i>PROG</i> | | These menu items are made visible by selecting the filter criteria in the <i>Filter</i> menu. |
| | <i>Date</i> | | |

4.6.3 Displaying measurement datasets

You can read out stored datasets to the display. Only those datasets are displayed that correspond to the selected filter criteria (see section 4.6.2).

Start reading out the data to the display in the menu, *Configuration / System / Measured value memory / Display*.

Representation of a dataset

```

Measured value
8: 02.12.2011 10:04:47
ID 0 / PROG 86
11.4 mg/l NH4-N
[BV] [1 + 1]
i Scroll with ▲ ▼
  
```

Further datasets that correspond to the filter criteria are displayed with the <▲> <▼> keys.

Quitting the display

To quit the display of stored measurement datasets, you have the following options:

- Switch directly to the measured value display with <M> (short pressure).
- Leave the display and switch to the superordinate menu with <ESC> or <START/ENTER>.

4.6.4 Download the measurement datasets to the RS232 interface

You can download stored datasets to the RS232 interface. Only those datasets are downloaded that correspond to the selected filter criteria (see section 4.6.2).

The datasets are downloaded in the specified output format (see section 4.7.5).

The data download to the interface is started in the menu, *Configuration / System / Measured value memory / RS232 download*.

4.6.5 Erasing stored measurement datasets

You can erase the stored measurement datasets altogether if you no longer need them.

Erasing all measurement datasets is done in the menu, *Configuration / System / Measured value memory / Delete*.

Erasing individual datasets is not possible. If all memory locations are occupied, however, it is possible to overwrite the oldest dataset at a time. A security prompt appears before a dataset is overwritten.

4.7 Transmitting data

To transfer data from the pHotoFlex® STD to a PC or printer, first establish a connection to a PC or printer (see section 4.7.1).

With the PC software LS Data you can, without further configuration, transmit or save measurement and calibration data for GLP-compliant data management to LS Data or transmit them to Excel and thus to LIMS (see section 4.7.2).

With the MultiLab® Importer (an add-in for Microsoft Excel) you can transmit data from the meter directly to an open Excel sheet (see section 4.7.3).

The connection to a printer or terminal program has to be configured so data can be safely transmitted (see section 4.7.5).

4.7.1 Establishing the connection to a PC

You have the following possibilities of transmitting data from the pHotoFlex® STD to a PC

- via the RS232 interface of the pHotoFlex® STD
or
- via the RS232 interface of the LabStation LS Flex/430
(accessories, see chapter 8)

?Prerequisites

- Microsoft Windows PC with one of the following operating systems:
 - Windows 7
 - Windows 8
 - Windows 10.
- Free interface of the PC
 - Serial COM interface
or
 - USB interface:
and USB adapter (accessory)

Establishing a connection

- Connection to the PC
 - Connecting cable AK 540/B (accessory, see chapter 8) or
 - LabStation LS Flex/430 (accessory, see chapter 8)
- 1 Connect the pHotoFlex® STD to the PC via the LabStation LS Flex/430 (see operating manual LS Flex/430).

The connection to the PC is established. The data can be transferred to the PC:

- via the PC software LS Data (see section 4.7.2)
- via the MultiLab® Importer (see section 4.7.3)
- via a terminal program (see section 4.7.6).

4.7.2 Data transmission with the PC software LS Data

With the PC software LS Data you can transmit and save to the LS Data any measurement- and calibration data for GLP compliant data management (menu item *File / Save As... / *. csv* (CSV format)) or transmit and save to Excel (menu item *Data exchange / Export (.xls)*) and thus transfer to LIMS.



The PC software LS Data is available as an accessory (LabStation LS Flex/430 with PC software LS Data, see chapter 8).

- 1 Establish the connection to a PC (see operating manual of the PC software LS Data and section 4.7.1).
- 2 Transmit data (see operating manual of the PC software LS Data).

4.7.3 Data transmission with the Excel add-in MultiLab® Importer



Set the CSV output format for datasets at the pHotoFlex® STD. It is selected in the menu, *Configuration / System / Interface / Output format* (see section 4.7.4 ESTABLISHING THE CONNECTION TO A PRINTER).

- 1 Establish the connection to a PC (see section 4.7.1).
- 2 Establish a data connection (see operating manual MultiLab® Importer).

- 3 Transmitting data (see section 4.7.6).

4.7.4 Establishing the connection to a printer

Via the RS 232 interface, you can transmit data to an external printer.

Suitable printers

- P3002 (see section 8 ACCESSORIES AND OPTIONS)
- P3001 (no longer available as accessory)

Socket assignment (RS232)

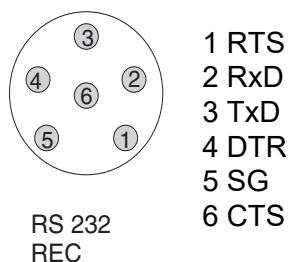

- 1 Connect the RS232 interface to the external printer with the AK540/S cable.



The pHotoFlex® pH is pre-configured for the connection of the printer.

- 2 For error-free data transmission:

The RS232 interface of the pHotoFlex® pH and the printer have to be set to the same transmission speed (*Baud rate*).

 - The baud rate of the pHotoFlex® STD is selected in the menu *Configuration / System / Interface / Baud rate*.
 - The setting of the baud rate of the printer and the default setting are in the documentation of your printer.
- 3 Selecting the output format of datasets (pHotoFlex® STD)

It is selected in the menu, *Configuration / System / Interface / Output format*.

Examples of the output formats (see section 4.7.6)
- 4 Transmitting data (see section 4.7.6).

Examples of transmitted data (see section 4.7.7)

4.7.5 Configuration for the data transmission to a terminal program

Via the RS232 interface you can also transmit data to a PC with the aid of a so-called terminal program.



When using the terminal program "HyperTerminal", you can load the transfer data automatically with the *.ht file stored on the CD.

- 1 Establish the connection to a PC (see section 4.7.1).
- 2 Determine the output format of datasets at the pHotoFlex® STD (see section 4.7.4 ESTABLISHING THE CONNECTION TO A PRINTER
It is selected in the menu, *Configuration / System / Interface / Output format*.
Examples of the output formats (see section 4.7.6)
- 3 Configure the RS232 interface of the pHotoFlex® STD and the terminal program.
The transmission data specified in the pHotoFlex® STD and terminal program have to match.
 - RS232 interface (see section 4.4.3).
 - Terminal (see operating manual of your terminal).

Transmission data:

| | |
|-----------|---|
| Baud rate | can be selected from: 1200, 2400, 4800, 9600, 19200 |
| Handshake | none |
| Parity | none |
| Data bits | 8 |
| Stop bits | 1 |

- 4 Transmit data (see section 4.7.6).
Examples of transmitted data (see section 4.7.7)

4.7.6 Transmitting data to a printer or terminal program

With a printer connected or a connection to a terminal program existing, you can transmit data in the following ways:

| Data | Operation / description |
|---|---|
| Individual data (e.g. measured value, calibration protocol, AQS protocol) | <ul style="list-style-type: none"> ● Display the data and press <PRT>. The data being shown on the display are transmitted to the interface. ● Simultaneously with every manual storage process. |
| Stored measured values | <ul style="list-style-type: none"> ● Display the saved data and press <PRT>. ● All datasets according to the filter criteria (section 4.4) via the <i>Ausgabe RS232/USB</i> function (see section 4.6.2.). |



With the **<PRT>** key you output data that is being shown on the display to the interface (displayed measured values, stored measurement datasets, calibration record).

4.7.7 Examples of data transmitted (printer, terminal program)

The data are output according to the selected output format.

The ASCII output format delivers formatted datasets.

**Example;
output format
ASCII**

```
pHotoFlex Ser. no. 12345678
01.12.11 09:56:20
ID 1/ PROG 83
1.74 mg/l NH4-N [BV]
-----
03.12.11 14:01:57
ID 2/ PROG 81
176 mg/l O2 [BV]
-----
etc...
```

Example, output format CSV

The CSV output format delivers datasets separated by ";".
The data are output in the following order:

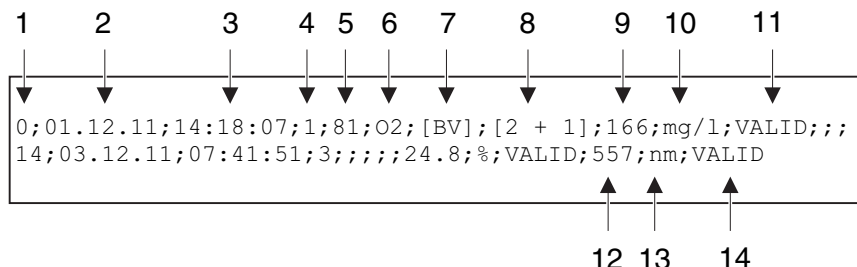

- 1 Current number of the storage location
(or "0" during output from measured value display)
- 2 Date of storing
- 3 Time of storing
- 4 Adjusted ID
- 5 Program number (only for the measured parameter, *Concentration*)
- 6 Citation form (only for the measured parameter, *Concentration*)
- 7 BV: Measured parameter *Concentration*: Blank value
- 8 Dilution (only for the measured parameter, *Concentration*)
- 9 Main measured value or
Upper/lower measuring range limit
(only with measured value status, OFL/UFL)
- 10 Unit of the main measured value
- 11 Measured value status of the main measured value
 - * VALID: Measured value valid
 - * INVALID: Measured value invalid
 - * UFL: Measured value below the lower measuring range limit
 - * OFL: Measured value above the upper measuring range limit
- 12 Secondary measured value or standard adjustment
for measured parameter *Absorbance / % Transmission*:
Wavelength of the measurement
for measured parameter *Concentration*: Status standard adjustment [Cal]
- 13 Unit of the secondary measured value
for the measured parameter, *Absorbance% Transmission*: nm
for the measured parameter, *Concentration*: Status standard adjustment [Cal]
- 14 Measured value status of the secondary measured value (see 11)



If the connected external printer does not print, please check whether the same baud rate is set at the pHotoFlex® STD and printer.

4.8 Reset

You can reset (initialize) all system and measurement settings.

4.8.1 Resetting the system settings

With the *System / Reset* function, all resettable settings are reset.

- Settings for *Photometry* (see section 4.8.2)
- System settings

| System setting | Default settings |
|-----------------------|------------------|
| <i>Baud rate</i> | 4800 Baud |
| <i>Output format</i> | ASCII |
| <i>Illumination</i> | <i>Auto off</i> |
| <i>Contrast</i> | 50 % |
| <i>Brightness</i> | 50 % |
| <i>Switchoff time</i> | 30 min |
| <i>Beep</i> | <i>On</i> |

4.8.2 Resetting the photometry settings

With the *Photometry / Reset* function, all settings are reset.

| Setting | Default settings |
|---------------------|----------------------|
| <i>PROG</i> | 0 |
| Cell size | 16 mm |
| <i>Meas. param.</i> | <i>Concentration</i> |
| Wavelength | 436 nm |
| Blank values | all erased |

4.9 Meter information

The following meter information is listed in the *Configuration / Info* menu:

- Model designation
- Software version
- Version number(s) of the stored program data
- Series number of the meter

```
Info
i  Model: pHotoFlex
i  Software: V 1.70
i  Prog.: V 1.24 W
i  Ser. no.: 12345678
```

4.10 Software update

With a software update you obtain the current software with all new programs and method data (see section 9).

A software update comprises

- new instrument software
- new programs (methods)
- revisions of existing methods

The current software version can be found on the Internet at www.xylemanalytics.com.

The proceeding for updating the software is given in the appendix (see section 9).

4.11 Administrating user-defined methods

4.11.1 Options for method administration

User-defined programs can be

- entered
- read out
- erased.

To store user-defined programs (methods) in the meter, determine a calibration line for your method yourself and transmit the data of this calibration line to the pHotoFlex® STD.

Administration of the method data can be carried out in the LSdata software (see LSdata operating manual) or with the aid of a terminal program (see section 4.11.2).

You need the following data in any case:

| Data | Possible entries/examples |
|--|--|
| <i>Program No:</i> | 900 ... 949 |
| <i>Model:</i> | Any name (max. 5 characters) |
| <i>Cell [mm]:</i> | 16 or 28 |
| <i>Wave length [nm]:</i> | 436, 517, 557, 594, 610 or 690 |
| <i>MRB (measuring range start):</i> | e.g. 0.05 |
| <i>MRE (measuring range end):</i> | e.g. 8.00 |
| <i>E0 (reagent blank value):</i> | e.g. 0.0 |
| <i>Slope:</i> | e.g. 1.0 |
| <i>Resolution:</i> | 0.0001, 0.001, 0.01, 0.1, 1, 2, 5, 10 or 100 |
| <i>Citation form:</i> | e.g. PO4-P (max. 9 characters) |
| <i>Unit:</i> | e.g. mg/l (max. 7 characters) |
| <i>Blank required:</i> (No/Yes) | 0 or 1 |
| <i>Standard adjustment possible:</i> (No/Yes) | 0 or 1 |
| <i>Standard adjustment required:</i> (No/Yes) | 0 or 1 |

4.11.2 Administrating user-defined programs with a terminal program

Generally, a terminal program serves to establish a connection to a device on a data interface and to communicate with the device via a console on the display.

Thus, it is also possible to send command lines.

Terminal programs are available for different operating systems by different manufacturers. Windows (version 95 to XP) contains the "HyperTerminal" terminal program. It is in the program menu under *Accessories*.

For more detailed information please refer to the user information of the terminal program.



On the CD-ROM there is a configuration file for the HyperTerminal program. By double clicking the configuration file (*.ht) you open the HyperTerminal program with the presettings required for data exchange with the meter.

The pHotoFlex® STD can administrate the database of user-defined programs via command lines.

- 1 With the aid of the AK 540/B interface cable, connect the pHotoFlex® STD to the serial interface (COM port) of the PC (see section 8.1.2).
- 2 Make sure the pHotoFlex® STD is switched on.
- 3 Start the terminal program on the PC.
- 4 Configure the connection settings for the COM interface as necessary.

Storing user-defined programs

Enter a command line according to the following scheme in the terminal program:

U.500#14, Program No, Model, Cell [mm], Wave length [nm], MRB, MRE, E0, Slope, Resolution, Citation form, Unit, Blank required, Standard adjustment possible, Standard adjustment required

Example:

```
U.500#14, 900, test, 16, 436, 0.0, 2.0, 0.0, 1.0, 0.01, test, mg/  
1, 0, 1, 0
```

The individual data sections of the command line are separated by commas. The dot "." has to be used as a decimal separator within a data section.

- 5 Enter the command line.
- 6 Finish the command line with Enter.
The data is transmitted to the pHotoFlex® STD.



If there is already a program stored under the selected number, the programming is canceled. If you wish to store the program under the selected number, you have to erase the program stored under the number first.

After a successful transmission, the terminal program writes "!>".
After a failed transmission, the terminal program writes "?>".

Erasing user-defined programs

To erase user-defined programs, enter a command line according to the following scheme in the terminal program:

| | Erase all user-defined programs | Erase one user-defined program |
|---------------------|--|---------------------------------------|
| Command line | U.520 | U.521#1, <i>Program No</i> |
| Example | U.520 | U.521#1,900 |

- 7 Enter the command line.
- 8 Finish the command line with Enter.
The data is transmitted to the pHotoFlex® STD.
The requested data is displayed on the terminal as the result.

After a successful transmission, the requested data is displayed on the terminal.
After a failed transmission, the terminal program writes "?>".

Reading out user-defined programs

To read out user-defined programs, enter a command line according to the following scheme in the terminal program:

| | Read out all user-defined programs | Read out one user-defined program |
|---------------------|---|--|
| Command line | U.510 | U.511#1, <i>Program No</i> |
| Example | U.510 | U.511#1,900 |

9 Enter the command line.

10 Finish the command line with Enter.

The data is transmitted to the pHotoFlex® STD.

The requested data is displayed on the terminal as the result.

After a successful transmission, the terminal program writes "!>".
After a failed transmission, the terminal program writes "?>".

5 Maintenance, cleaning, disposal

5.1 Maintenance

The meter is almost maintenance-free.
The only maintenance task is replacing the batteries or battery pack.

5.1.1 Inserting/exchanging the batteries

NOTE

Make sure that the poles of the batteries are positioned correctly.
The ± signs on the batteries must correspond to the ± signs in the battery compartment.

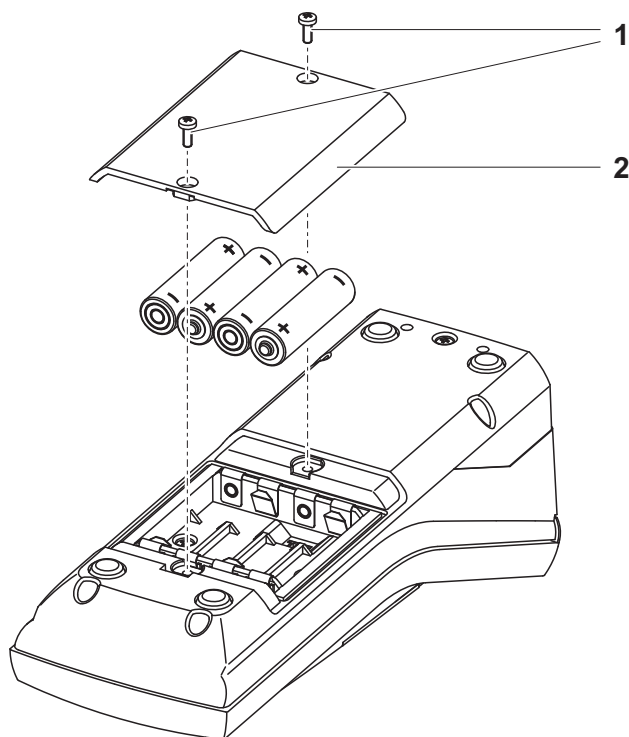

- 1 Open the battery compartment:
 - Unscrew the two screws (1) on the underside of the meter,
 - Remove the lid of the battery compartment (2).
- 2 If necessary, take four old batteries out of the battery compartment.
- 3 Insert four batteries (3) in the battery compartment.
- 4 Close the battery compartment and fix it with the screws.



Dispose of used batteries according to the local regulations of your country.

End users within the European Union are obligated to return used batteries (even ecologically compatible ones) to a collection point set up for recycling purposes.

Batteries are marked with the crossed-out waste container symbol. Therefore, they may not be disposed with the domestic waste.

5.1.2 Retrofitting the battery pack

NOTE

Use original WTW battery packs only.

Together with the power pack the battery pack is available as an accessory (see section 8.1).

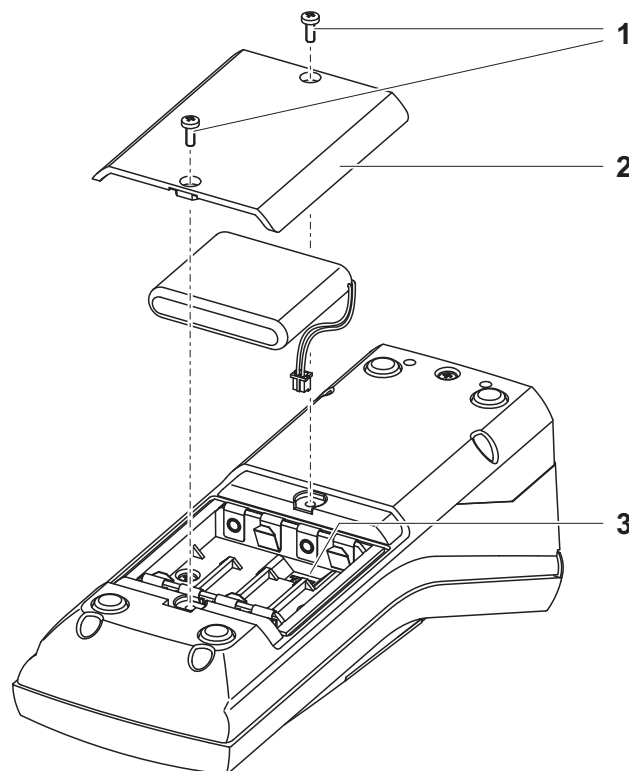

- 1 Open the battery compartment:
 - Unscrew the two screws (1) on the underside of the meter,
 - Remove the lid of the battery compartment (2).

- 2 If necessary, take four old batteries out of the battery compartment.
- 3 Connect the cable of the battery pack with the socket (3) on the bottom of the battery compartment and insert the battery pack in the battery compartment.
- 4 Close the battery compartment and fix it with the screws.



Dispose of used batteries according to the local regulations of your country.

End users within the European Union are obligated to return used batteries (even ecologically compatible ones) to a collection point set up for recycling purposes.

Batteries are marked with the crossed-out waste container symbol. Therefore, they may not be disposed with the domestic waste.

5.2 Cleaning

Occasionally wipe the outside of the measuring instrument with a damp, lint-free cloth. Disinfect the housing with isopropanol as required.

NOTE

The housing parts are made of plastic (polyurethane, ABS and PMMA) and are only conditionally resistant against organic solvents. Thus, avoid contact with acetone and similar detergents that contain solvents. Remove any splashes immediately.

5.2.1 Cleaning the cell shaft

If liquid is in the cell shaft (e.g. due to a spilled cell), clean the cell shaft as follows:



CAUTION

leased, observe the hazard information on the cell. If necessary, take corresponding protective measures (protective goggles, protective gloves etc.).

- 1 Switch the pHotoFlex® STD off and pull out the power plug.
- 2 Rinse the cell shaft with distilled water.

5.2.2 Cleaning the cells

Cells have to be clean, dry, and free of fingerprints. Therefore, clean them regularly:

- 1 Clean the cells inside and out with hydrochloric acid or laboratory soap.
- 2 Rinse out several times with distilled water.
- 3 Let them dry in the air.
- 4 Only hold the cells by the top or by the light protection cap so that the optical path is not impaired.
- 5 Before measuring, clean the cell with the enclosed cleaning cloth.

5.3 Packing

This meter is sent out in a protective transport packing.



We recommend: Keep the packing material. The original packing protects the meter against damage during transport.

5.4 Disposal

Batteries

Dispose of used batteries according to the local regulations of your country (see section 5.1.1).

Meter

At the end of its operational lifetime, the meter must be returned to the disposal or return system statutory in your country. If you have any questions, please contact your supplier.

6 What to do if...

6.1 General errors

| | | |
|---|---|---|
| Display, LoBat | Cause – The batteries or battery pack are largely depleted | Remedy – Insert new batteries – Charge the battery pack (see section 3.2) |
| Meter does not react to keystroke | Cause – Software error – Operating condition undefined or EMC load unallowed | Remedy – Processor reset: Press the <START/ENTER> and <PRT> keys simultaneously. |
| RS232 interface does not react | Cause – Software error – Operating condition undefined or EMC load unallowed | Remedy – Processor reset: Press the <START/ENTER> and <PRT> keys simultaneously. |
| Error message, Error 0, 8, 16, 16384 | Cause – Instrument error | Remedy – Repeat measurement – Meter defective, send meter to WTW for repair and quote the error number |

6.2 Photometry

| Measuring range exceeded or undershot | Cause | Remedy |
|---------------------------------------|---|---|
| | – Program not suitable | – Select program with suitable measuring range – Dilute the sample |
| Obviously incorrect measured values | Cause | Remedy |
| | – Measurement disturbed by external light | – Close the external light cover. |
| | – Cell not correctly inserted | – Insert the cell so that it is positioned on the bottom of the cell shaft. |
| | – Cell contaminated | – Clean the cell |
| | – Cell shaft contaminated | – Clean the cell shaft |
| | – Dilution set incorrectly | – Set the dilution |
| | – Selected program unsuitable | – Select other program |
| | – Zero measurement incorrect | – Perform zero measurement |
| | – Blank value incorrect | – Remeasure the blank value |

7 Technical data

7.1 General data

7.1.1 pHotoFlex® STD

| | | |
|------------------------------------|---------------------------------------|---|
| Dimensions | Approx. 236 x 86 x 117 mm | |
| Weight | Approx. 0.6 kg (without batteries) | |
| Mechanical structure | Type of protection | IP 67 |
| Electrical safety | Protective class | III |
| Test certificates | CE, FCC | |
| Ambient conditions | Storage | - 25 °C ... + 65 °C |
| | Operation | 0 °C ... + 50 °C |
| | Climatic class | 2 |
| Allowable relative humidity | Yearly mean: | 75 % |
| | 30 days /year: | 95 % |
| | Other days: | 85% |
| Power supply | Batteries | 4 x 1.5 V, type AA |
| | Operating time with battery operation | approx. 5000 measurements |
| | Battery pack (optional) | 5 x 1.2 V nickel metal hydride (NiMH), type AA |
| | Power pack Charging device (optional) | FRIWO FW7555M/09, 15.1432.500-00 Friwo Part. No. 1883259 ----- RiHuiDa RHD20W090150 ----- Input: 100 ... 240 V ~ / 50 ... 60 Hz / 400 mA Output: 9 V = / 1,5 A Connection max. overvoltage category II Primary plugs contained in the scope of delivery: Euro, US, UK and Australian. |

| | | |
|----------------------------------|--|--|
| Serial interface | Connection of the cable AK 540/B or AK 540/S | |
| | Baud rate | Adjustable: 1200, 2400, 4800, 9600, 19200 Baud |
| | Type | RS232 |
| | Data bits | 8 |
| | Stop bits | 2 |
| | Parity | None |
| | Handshake | RTS/CTS |
| | Cable length | Max. 15 m |
| Guidelines and norms used | EMC | EC directive 89/336/EEC EN 61326-1/A3:2003 FCC Class A |
| | Meter safety | EEC guideline 73/23/EEC EN 61010-1 :2001 |
| | Climatic class | VDI/VDE 3540 |
| | IP protection class | EN 60529:1991 |

7.2 Photometry

| | | |
|------------------------------------|---|-------------------|
| Optical measuring principle | LED photometer with filter | |
| Interference filter | 436 nm, 517 nm, 557 nm, 594 nm, 610 nm, 690 nm | |
| | Accuracy: | ± 2 nm |
| Photometric reproducibility | 0.005 or better | |
| Photometric resolution | 0.001 | |
| Warm-up time | None | |
| Measuring time | Approx. 2s | |
| Measured parameters | Concentration (method dependent, selectable display type), absorbance, transmission | |
| Measuring range | Absorbance: | -2.000 ... +2.000 |

| | | |
|------------------------------|---------------|-------------|
| | Transmission: | 1 ... 150 % |
| User-defined programs | | 50 |
| Resolution | 1.00 ... 9.99 | 0.01 % |
| Transmission | 10.0 ... 150 | 0.1 % |

8 Accessories and options

8.1 Accessories

8.1.1 Meter accessories

| Description | Model | Order no. |
|---|-------------|-----------|
| LabStation with LSdata PC software, battery pack and universal power pack | LS Flex/430 | 251 301 |
| Batteries for pHotoFlex | RB Flex/430 | 251 300 |
| 25 empty round cells (16 mm) | RK 14/25 | 250 621 |
| 3 empty round cells (28 mm) | LK28-Set | 251 302 |
| Thermoprinter* | P3001 | 250 045 |
| Needle printer* | LQ 300+ | 250 046 |

* a connection cable is required to connect the printer (see section 8.1.2)

8.1.2 Connection cable:

PC You can connect a PC to the pHotoFlex® STD in one of the following ways:

| Description | Model | Order no. |
|---|---|-----------|
| ● Connection PC - pHotoFlex® STD | | |
| – Cable | AK 540/B | 902 842 |
| + USB adapter (for USB connection on PC) | ADA USB | 902 881Y |
| ● Connection PC - LabStation | | |
| – Zero modem cable | included in the scope of delivery of the LabStation | |
| + USB adapter (for USB connection on PC) | ADA USB | 902 881Y |

Thermoprinter

You can connect the P3001 thermoprinter to the pHotoFlex® STD in the following ways:

| Description | Model | Order no. |
|---|-----------------------------|-----------|
| ● Connection P3001 - | | |
| – Cable | AK 540/S | 902 843 |
| ● Connection P3001 - LabStation | | |
| – Cable in conjunction with an adapter (socket - socket) [GenderChanger] | AK 3000 Specialist shops | 250 745 |
| or: | | |
| – Cable, 2 x 9-pin (socket - plug) | Specialist shops | |

Matrix printer

You can connect an LQ300 needle printer to the pHotoFlex® STD in one of the following ways:

| Description | Model | Order no. |
|---|------------------------------|-----------|
| ● Connection LQ300 - | | |
| – Cable with adapter 9-pin (plug) - 25-pin (plug) | AK 540/B Specialist shops | 902 842 |
| ● Connection LQ300 - LabStation | | |
| – Cable in conjunction with an adapter (socket - socket) [GenderChanger] | AK/LQ300 Specialist shops | 250 746 |
| or: | | |
| – Zero modem cable, 9-pin (socket) - 25-pin (plug) | Specialist shops | |

8.2 Bar code reader

The following optional extensions are available in specialist shops:

| Device/cable | Model |
|--|--|
| Bar code reader* | <ul style="list-style-type: none">● Handscanner Datalogic DLC6065-M1● Handscanner Datalogic Touch65 |
| Connection cable Bar code reader - LabStation | Datalogic CAB-350 |

* In addition to the bar code reader, a suitable connection cable is required to operate the bar code reader

9 Firmware update

General information

With the aid of a PC, you can update the firmware of the pHotoFlex® STD to the latest version.

You can find available firmware update files for your meter on the Internet.

The update program contains:

- the newest firmware (meter software)
- new or changed method data and programs.

Connecting the meter to the PC

The following is required for connection to a PC:

- a free serial interface (COM or USB port) on your PC
- cable or LabStation with cable for connection to PC
 - for direct connection of the meter to the PC:
the AK 540/B interface cable (accessory) or
 - for connection with the LabStation:
an operable LabStation with null modem cable (accessory, see LabStation operating manual)
- for connection to a USB interface on the PC:
a USB adapter (accessory).



Prior to starting the update please make sure that the batteries are fully loaded, or operate the pHotoFlex® STD with the LabStation. Otherwise there is the risk of the pHotoFlex® STD crashing during the update.

Program installation

Install the firmware update program on your PC.

Under Microsoft Windows 7, administrator rights are required.

Program start

Start the program from the Windows start menu.

Via the language menu you can change the adjusted language.

Firmware update

Proceed as follows:

- 1 Connect the pHotoFlex® STD to an interface of the PC.
- 2 Make sure the pHotoFlex® STD is switched on.
- 3 To start the updating process click the OK button.

- 4 Then follow the instructions of the program.
The programming process takes approx. 5 minutes.
A terminatory message is displayed after a successful programming process. The firmware update is now completed.
- 5 Disconnect the meter from the PC.
The meter is ready for operation.

After switching the meter off and on you can check whether the meter has taken over the new software version on the start display.

10 Disposal

Handle and dispose of all waste in compliance with local laws and regulations.

EU only: Correct disposal of this product — WEEE Directive on waste electrical and electronic equipment

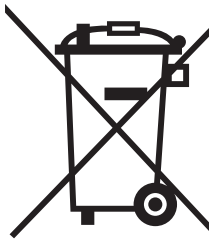

This marking on the product, accessories or literature indicates that the product should not be disposed of with other waste at the end of its working life.

To prevent possible harm to the environment or human health from uncontrolled waste disposal, please separate these items from other types of waste and recycle them responsibly to promote the sustainable reuse of material resources.



Waste from electrical and electronic equipment can be returned to the producer or distributor.

EU only: Correct disposal of batteries in this product

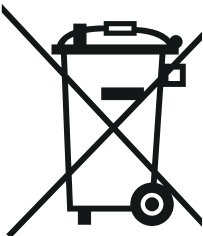

This marking on the battery, manual or packaging indicates that the batteries in this product should not be disposed of with other waste at the end of its working life. Where marked, the chemical symbols Hg, Cd or Pb indicate that the battery contains mercury, cadmium or lead above the reference levels in Directive 2006/66/EC. If batteries are not properly disposed of, these substances can cause harm to human health or the environment.

To protect natural resources and to promote material re-use, please separate batteries from other types of waste and recycle them through your local, free battery return system.

11 Lists

This chapter provides additional information and orientation aids.

Abbreviations

The list of abbreviations explains the indicators and the abbreviations that appear on the display and in the manual.

Specialist terms

The glossary briefly explains the meaning of the specialist terms. However, terms that should already be familiar to the target group are not described here.

Abbreviations

| | |
|-------|--------------------------------------|
| d | Day |
| h | Hour |
| j | Year |
| K | Temperature unit, Kelvin |
| LoBat | Batteries almost empty (Low battery) |
| m | Month |
| s | Second |
| SELV | Safety Extra Low Voltage |

Glossary

Analysis specification

The exact proceeding to carry out the detection procedure is described in the analysis instructions.

Blank value (reagent blank value)

The evaluation of the photometric measurement always refers to the comparison value of a sample without the substance to be determined (reagent blank value). Thus the influence of the basic absorbance of the reagents on photometric measurement is compensated for.

Cell

Vessel that takes a liquid sample for the photometric measurement. The cell material (mostly glass) must have certain optical features to be suitable for photometry.

| | |
|----------------------------|---|
| Citation forms | <p>Different forms of representing a measured concentration value that can be derived from each other.</p> <p>The method for determining phosphate provides, for example, a measured value for phosphorous P. This measured value can also be quoted in other citation forms such as PO₄, PO₄-P or P₂O₅.</p> |
| Detection procedure | <p>The detection procedure designates the general principle of how a sample is brought into a form suitable for measurement.</p> <p>Different methods can be based on the same detection procedure.</p> |
| LED | <p>Light Emitting Diode</p> <p>LEDs are used as the light source in the pHotoFlex® STD.</p> |
| Measured value | <p>The measured value is the special value of a measured parameter to be determined. It is given as a combination of the numerical value and unit (e.g. 3 m; 0.5 s; 5.2 A; 373.15 K).</p> |
| Method | <p>A method comprises a chemical detection procedure and special method data (calibration line) that are required to evaluate the measurement results.</p> <p>How to carry out the method up to the photometric measuring is described in the analysis instructions.</p> <p>The pHotoFlex® STD contains a database with methods (programs). Furthermore, user-defined methods can be entered in the database as well.</p> |
| Program | <p>In the pHotoFlex® STD, methods with the relevant method data are stored as programs.</p> <p>Programs are called up via the assigned program number.</p> |
| Reset | <p>Restoring the original condition of all settings of a measuring system.</p> |
| Resolution | <p>Smallest difference between two measured values that can be displayed by a meter.</p> |
| Test set (test) | <p>A test set contains all reagents that are required for the photometric determination of the sample according to the analysis instructions.</p> |
| Zero adjustment | <p>Adjusting a photometer with a water-filled cell.</p> <p>The zero adjustment applies to measuring all measured parameters (concentration, absorbance, transmission) of a photometer.</p> |

12 Index

A

| | |
|---|--------|
| Absorbance / % Transmission, measuring .. | 39 |
| Analysis specification | 30 |
| Analysis timer | 42 |
| Automatic switch-off function | 12, 15 |

B

| | |
|-------------------------------|----|
| Blank value | 34 |
| Blank value measurement | 35 |

C

| | |
|---------------------------------|----|
| Cleaning | 62 |
| Concentration measurement | 32 |
| Connectors | 9 |

D

| | |
|----------------------------|-------|
| Data filter | 46 |
| Dataset | 44 |
| Date and time | 22 |
| Date/time | 29 |
| Default settings | |
| System settings | 54 |
| Display | 8, 28 |
| Display illumination | 8, 16 |

F

| | |
|-----------------------|----|
| Filter | 46 |
| Firmware update | 72 |

I

| | |
|-----------------------------|----|
| Initial commissioning | 14 |
| Initialize | 54 |
| Inserting a cell | 16 |
| Interface | 29 |

K

| | |
|---------------------|---|
| Key functions | 7 |
| Keys | 7 |

M

| | |
|------------------------------|----|
| Measure diluted sample | 43 |
| Measured value display | 19 |
| Measurement data memory | |
| Storage locations | 44 |

| | |
|---------------------------|----|
| Measurement dataset | 44 |
| Menus (navigation) | 19 |
| Messages | 20 |
| Method | 30 |

N

| | |
|------------------|----|
| Navigation | 19 |
|------------------|----|

O

| | |
|-----------------------|----|
| Operating modes | 18 |
|-----------------------|----|

P

| | |
|---------------------------------|----|
| Photometric determination | 30 |
| Program | 30 |
| Programs | 41 |

R

| | |
|-------------------------------|----|
| Reset | 54 |
| RS232 socket assignment | 50 |

S

| | |
|---------------------------|--------|
| Safety | 10 |
| Scope of delivery | 12 |
| Storage | 27 |
| Storing in memory | 44 |
| Switching on | 15 |
| System menu | |
| General information | 28, 31 |
| System settings | 26 |
| General information | 26, 29 |

T

| | |
|------------------------------------|----|
| Test set | 30 |
| Timer | 42 |
| Transmitting data | 48 |
| Transmitting measured values | 48 |

U

| | |
|-----------------------------|----|
| User-defined programs | 42 |
|-----------------------------|----|

Z

| | |
|-----------------------|----|
| Zero adjustment | 40 |
|-----------------------|----|

Xylem |'zīləm|

- 1) The tissue in plants that brings water upward from the roots;
- 2) a leading global water technology company.

We're a global team unified in a common purpose: creating advanced technology solutions to the world's water challenges. Developing new technologies that will improve the way water is used, conserved, and re-used in the future is central to our work. Our products and services move, treat, analyze, monitor and return water to the environment, in public utility, industrial, residential and commercial building services settings. Xylem also provides a leading portfolio of smart metering, network technologies and advanced analytics solutions for water, electric and gas utilities. In more than 150 countries, we have strong, long-standing relationships with customers who know us for our powerful combination of leading product brands and applications expertise with a strong focus on developing comprehensive, sustainable solutions.

For more information on how Xylem can help you, go to www.xylem.com.



Service and Returns:

Xylem Analytics Germany
Sales GmbH & Co. KG
WTW
Am Achalaich 11
82362 Weilheim
Germany

Tel.: +49 881 183-325
Fax: +49 881 183-414
E-Mail wtw.rma@xylem.com
Internet: www.xylemanalytics.com



Xylem Analytics Germany GmbH
Am Achalaich 11
82362 Weilheim
Germany

