

photoFlex[®] pH

LED FILTER PHOTOMETER WITH pH FUNCTION



a xylem brand

Copyright © 2022 Xylem Analytics Germany GmbH
Printed in Germany.

pHotoFlex® pH - Contents

1	Overview	6
1.1	General features	6
1.2	Keypad	7
1.3	Display	9
1.4	Socket field	9
1.5	LabStation (optional)	10
2	Safety	11
2.1	Safety information	11
2.1.1	Safety information in the operating manual	11
2.1.2	Safety signs on the meter	11
2.1.3	Further documents providing safety information	11
2.2	Safe operation	12
2.2.1	Authorized use	12
2.2.2	Requirements for safe operation	12
2.2.3	Unauthorized use	12
3	Commissioning	13
3.1	Scope of delivery	13
3.2	Power supply	13
3.2.1	General information	13
3.2.2	Inserting/exchanging the batteries	15
3.3	Initial commissioning	16
4	Operation	17
4.1	Switching on the meter	17
4.2	Inserting a cell	18
4.3	General operating principles	20
4.3.1	Operating modes	20
4.3.2	Navigation	21
4.3.3	Navigation example 1: Setting the language	22
4.3.4	Example 2 on navigation: Setting the date and time	24
4.3.5	Menu overview	26
4.4	System settings (<i>System</i> menu)	28
4.4.1	<i>Measured value memory</i>	29
4.4.2	<i>Display</i>	30
4.4.3	<i>Interface</i>	30
4.4.4	<i>Date/time</i>	31
4.5	Photometry	31
4.5.1	General information	31

- 4.5.2 Settings for photometric measurements 33
- 4.5.3 Measuring the concentration 33
- 4.5.4 Blank value (reagent blank value) 36
- 4.5.5 Standard adjustment (user calibration) 38
- 4.5.6 Absorbance / % Transmission, measuring 40
- 4.5.7 Zero adjustment 41
- 4.5.8 Programs 43
- 4.5.9 *Analysis timer* 43
- 4.5.10 *Timer* 44
- 4.5.11 Measuring diluted samples 44
- 4.6 pH value / ORP voltage 46
 - 4.6.1 General information 46
 - 4.6.2 Measuring the pH value 47
 - 4.6.3 Measuring the ORP 47
 - 4.6.4 Settings for pH and ORP measurements 48
 - 4.6.5 Calibration 49
 - 4.6.6 Carrying out the TEC and NIST/DIN calibration 52
- 4.7 Memory 56
 - 4.7.1 Storing measurement datasets 57
 - 4.7.2 Filtering measurement datasets 58
 - 4.7.3 Displaying measurement datasets 58
 - 4.7.4 Output measurement datasets to the RS232 interface 59
 - 4.7.5 Erasing stored measurement datasets 59
- 4.8 Transmitting data 60
 - 4.8.1 Establishing the connection to a PC 60
 - 4.8.2 Data transmission with the PC software LS Data 61
 - 4.8.3 Data transmission with the Excel add-in MultiLab® Importer 61
 - 4.8.4 Establishing the connection to a printer 62
 - 4.8.5 Configuration for the data transmission to a terminal program 63
 - 4.8.6 Transmitting data to a printer or terminal program 64
 - 4.8.7 Examples of data transmitted (printer, terminal program) 64
- 4.9 Reset 66
 - 4.9.1 Resetting the system settings 66
 - 4.9.2 Resetting the photometry settings 66
 - 4.9.3 Resetting the settings for pH measurements ... 67
- 4.10 Meter information 67
- 4.11 Software update 67
- 4.12 Administrating user-defined methods 68
 - 4.12.1 Administrating user-defined programs with a terminal program 69

5	Maintenance, cleaning	72
5.1	Maintenance	72
5.1.1	Inserting/exchanging the batteries	72
5.1.2	Retrofitting the battery pack	73
5.2	Cleaning	74
5.2.1	Cleaning the cell shaft	74
5.2.2	Cleaning the cells	75
5.3	Packing	75
6	What to do if...	76
6.1	General errors	76
6.2	Photometry	77
6.3	pH value / ORP voltage	77
7	Technical data	80
7.1	General data	80
7.2	Photometry	81
7.3	pH value / ORP voltage	82
8	Accessories and options	83
8.1	Accessories	83
8.1.1	Connecting cable	83
8.2	Optional extensions of the pHotoFlex® pH	85
9	Firmware update	86
10	Disposal	88
11	Lists	89
12	Index	95

1 Overview

1.1 General features

The compact pHotoFlex® pH handheld precision meter enables you to carry out the following measurements quickly and reliably:

- Photometric measurements
 - Concentration measurements (colorimetric measurements)
 - Absorbance measurements
 - Transmission measurements
- pH measurements.

The pHotoFlex® pH handheld meter provides the maximum degree of ease of use, reliability and measuring certainty for all applications.

The proven MultiCal® calibration procedure supports you in calibrating for pH measurements, and the AutoRead function enables precise pH measurements.

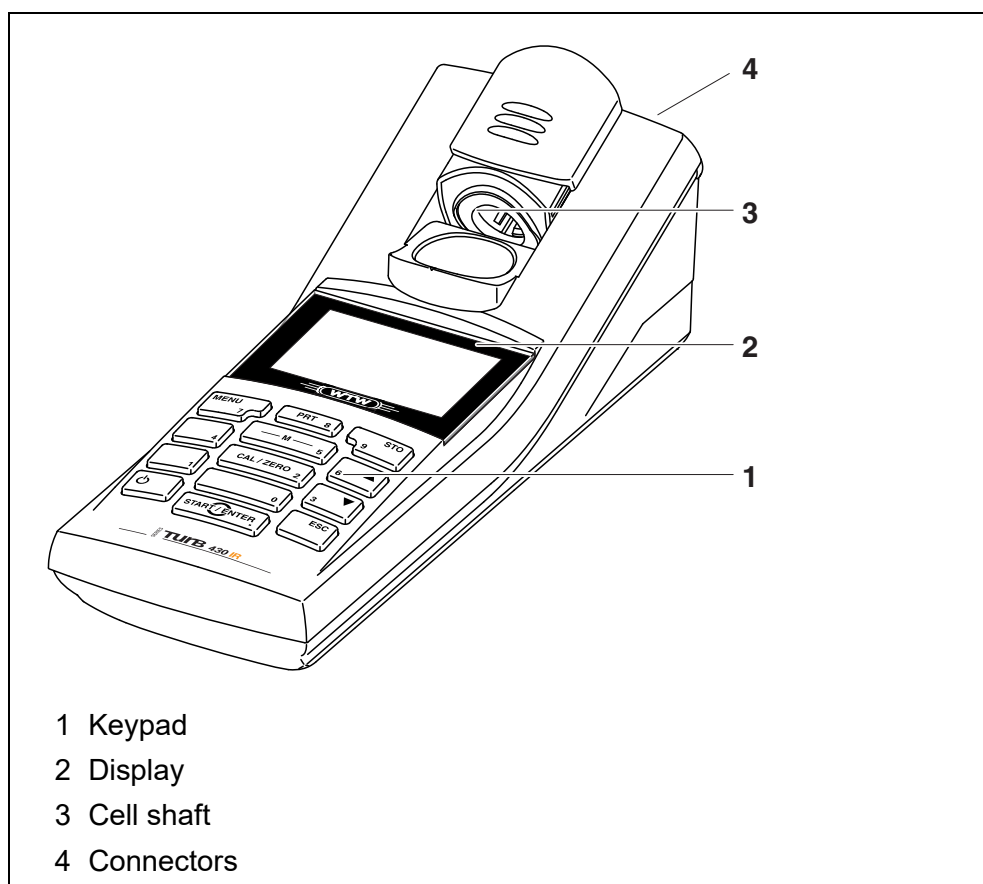



If you need further information or application notes, you can obtain the following material from WTW:

- Application reports
- Primers
- Safety datasheets.

You will find information on available literature in the WTW catalog or on the Internet.

1.2 Keypad



Key functions



Select the measuring mode
<M> (long keystroke):

- *Photometry*
- *pH & ORP*

Select the measured parameter within a measuring mode











<M> (short keystroke):

- *pH & ORP: pH, ORP*
- *Photometry: Concentration, Absorbance, % Transmission*
-



Start calibration (Measuring mode *pH & ORP*)

Start zero adjustment or blank value measurement using the *Photometry \ Adjustment* menu (measuring mode, *Photometry*) <CAL/ZERO>

	<p>In the <i>Photometry</i> measuring mode: Select a program for concentration measurement <PROG></p>
	<p>Open menus / confirm entries / start measurement <START/ENTER></p>
	<p>Call up the <i>Configuration</i> menu (all settings are made here) <MENU></p>
	<p>In the <i>Photometry</i> measuring mode, measured parameter, <i>Concentration</i>: Switch over between available citation forms <FORM></p>
	<p>In the <i>Photometry</i> measuring mode, measured parameter, <i>Concentration</i>: Switch over between available units <UNIT></p>
	<p>Switch the meter on or off <ON/OFF></p>
	<p>Output the display contents to the RS232 interface (e.g. print) <PRT></p>
	<p>Open the <i>Store</i> menu: <STO> Quick storing: 2 x <STO></p>
	<p>Highlight menu items or selection; Set the values <▲ >, <▼ ></p>
	<p>Switch to the next higher menu level / cancel input <ESC></p>



Entering numerals with the number keys (see ENTERING NUMERALS WITH THE NUMBER KEYS, page 22).

1.3 Display

The graphic display shows all information of the current measurement in the measured value display. The illumination enables to read the display even in the dark.

Example

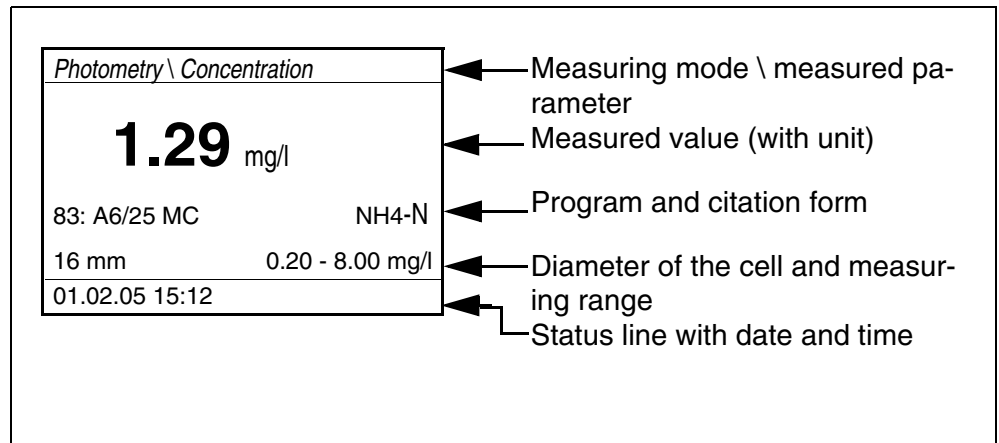

1.4 Socket field

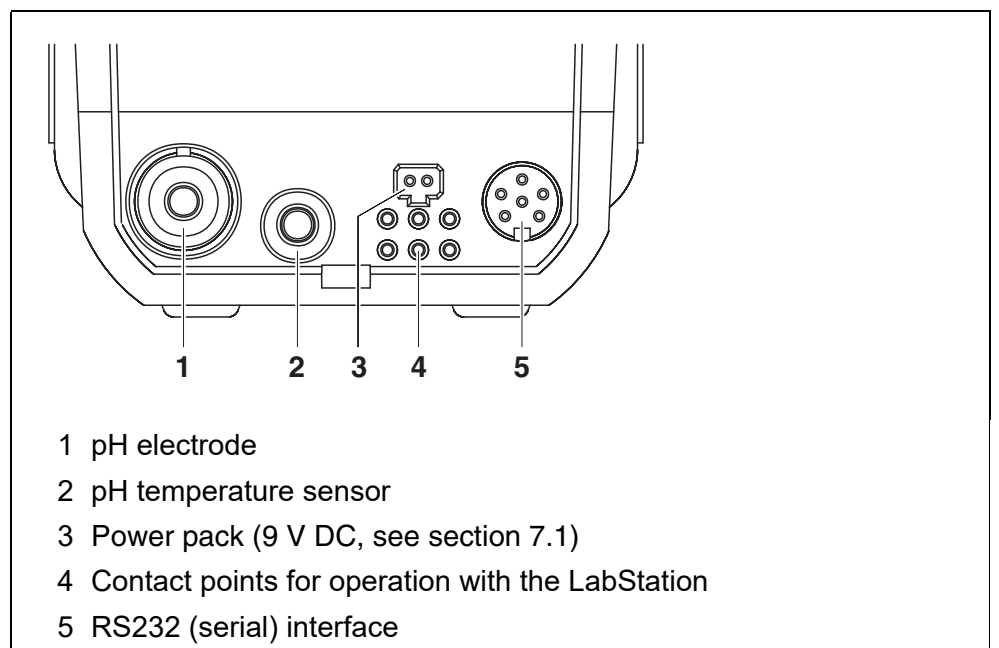

1.5 LabStation (optional)

The LabStation, which is available as an accessory, enables you to use the pHotoFlex® pH conveniently in the laboratory (see LabStation operating manual).

Laboratory operation with the LabStation enables the following additional functions:

- With photometric measurements, the zero measurement is retained even after switching the pHotoFlex® pH off and on again
- You can connect a barcode reader for the simplified calling up of programs
- The LSdata software included serves to easily enter user-defined programs
- Operation with power pack and battery pack (included in the scope of delivery of the LabStation). The accumulator pack in the pHotoFlex® pH is automatically charged as soon as the meter is placed in the LabStation.

2 Safety

2.1 Safety information

2.1.1 Safety information in the operating manual

This operating manual provides important information on the safe operation of the meter. Read this operating manual thoroughly and make yourself familiar with the meter before putting it into operation or working with it. The operating manual must be kept in the vicinity of the meter so you can always find the information you need.

Important safety instructions are highlighted in this operating manual. They are indicated by the warning symbol (triangle) in the left column. The signal word (e.g. "CAUTION") indicates the level of danger:



WARNING

indicates a possibly dangerous situation that can lead to serious (irreversible) injury or death if the safety instruction is not followed.



CAUTION

indicates a possibly dangerous situation that can lead to slight (reversible) injury if the safety instruction is not followed.

NOTE

indicates a possibly dangerous situation where goods might be damaged if the actions mentioned are not taken.

2.1.2 Safety signs on the meter

Note all labels, information signs and safety symbols on the meter and in the battery compartment. A warning symbol (triangle) without text refers to safety information in this operating manual.

2.1.3 Further documents providing safety information

The following documents provide additional information, which you should observe for your safety when working with the measuring system:

- Operating manuals of further accessories
- Safety datasheets of the test reagents for working with photometric test sets.
- Safety datasheets of calibration or maintenance accessories (such as buffer solutions, electrolyte solutions, etc.)

2.2 Safe operation



CAUTION

Danger of eye damage by visible and invisible LED radiation. In the cell shaft of the pHotoFlex® pH there are light emitting diodes (LEDs) of the 1M class.

Do not look at the radiation using optical instruments. With normal, authorized use there is no hazard.

2.2.1 Authorized use

This meter is authorized exclusively for carrying out the following measurements in the laboratory:

- Analysis of substances in water and aqueous solutions using round cells
- Concentration measurement
- Absorbance and transmission measurement

Only the operation and running of the meter according to the instructions and technical specifications given in this operating manual is authorized (see chapter 7 TECHNICAL DATA).

Any other use is considered unauthorized.

2.2.2 Requirements for safe operation

Note the following points for safe operation:

- The meter may only be operated according to the authorized use specified above.
- The meter may only be supplied with power by the energy sources mentioned in this operating manual.
- The meter may only be operated under the environmental conditions mentioned in this operating manual.
- The meter may only be opened if this is explicitly described in this operating manual (example: Inserting the batteries).

2.2.3 Unauthorized use

The meter must not be put into operation if:

- it is visibly damaged (e.g. after being transported)
- it was stored under adverse conditions for a lengthy period of time (storing conditions, see chapter 7 TECHNICAL DATA).

3 Commissioning

3.1 Scope of delivery

- Handheld meter, pHotoFlex® pH
- 4 batteries 1.5 V type AA (in the battery compartment)
- 1 empty cell 16 mm
-
- Microfiber cloth to clean the meter
- Compact operating manual
- Overview of the keys / available programs
- CD-ROM with
 - Detailed operating manual
 - Photometry analysis manual with analysis specifications
 - Software to program user-defined methods
- Optional: LabStation with LSdata PC software, battery pack and universal power pack
- Optional: Battery pack (rechargeable)



The optional parts of the scope of delivery are available as accessories (see section 8.1).

3.2 Power supply

3.2.1 General information

You can operate the meter either with batteries, battery pack or a power pack. The power pack supplies the meter with low voltage (9 V DC). At the same time, the battery pack is charged. The battery pack is charged even while the meter is switched off.

The *LoBat* display indicator appears when the batteries or battery pack are nearly discharged.

approx. 36 hours.

Charging time of the battery pack



CAUTION

**Use original power packs only.
The line voltage at the operating site must lie within the input voltage range of the original power pack (see chapter 7 TECHNICAL DATA).**



The battery pack should not be completely discharged. If you do not operate the instrument for a longer period of time you should charge the battery pack every six months.

Automatic switch-off function

The meter has an automatic switch-off function in order to save the batteries or battery pack (see section 4.4).

Display illumination

During operation with the batteries or battery pack the meter automatically switches off the display illumination if no key is pressed for 30 seconds. The illumination is switched on with the next keystroke again. The display illumination can also be switched off completely (see section 4.4.2).



The power pack and battery pack are available as accessories (see section 8.1).

Connecting the power pack (optional)

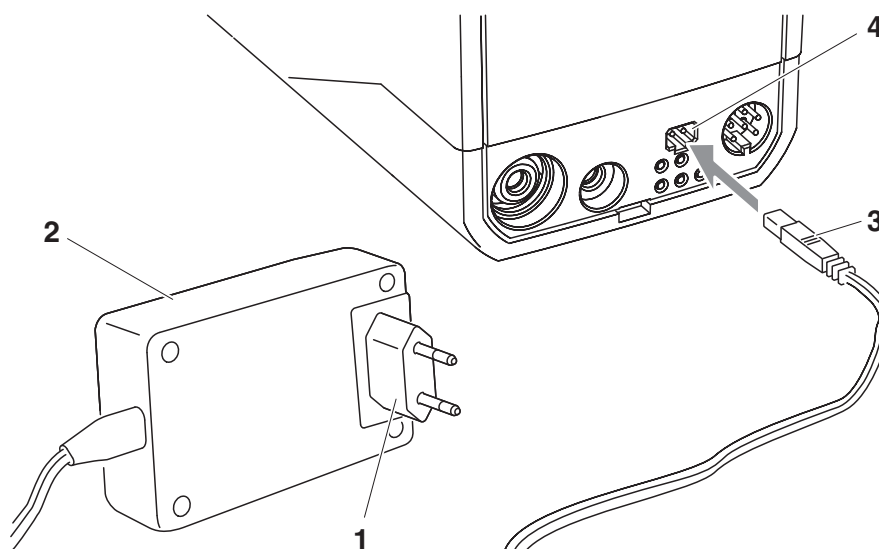

- 1 If necessary, replace the Euro plug (1) of the power pack (2) by the country-specific plug suitable for your country.
- 2 Connect the plug (3) to the socket (4) of the measuring instrument.
- 3 Connect the power pack unit to an easily accessible mains socket.

3.2.2 Inserting/exchanging the batteries

NOTE

Make sure that the poles of the batteries are positioned correctly. The ± signs on the batteries must correspond to the ± signs in the battery compartment.

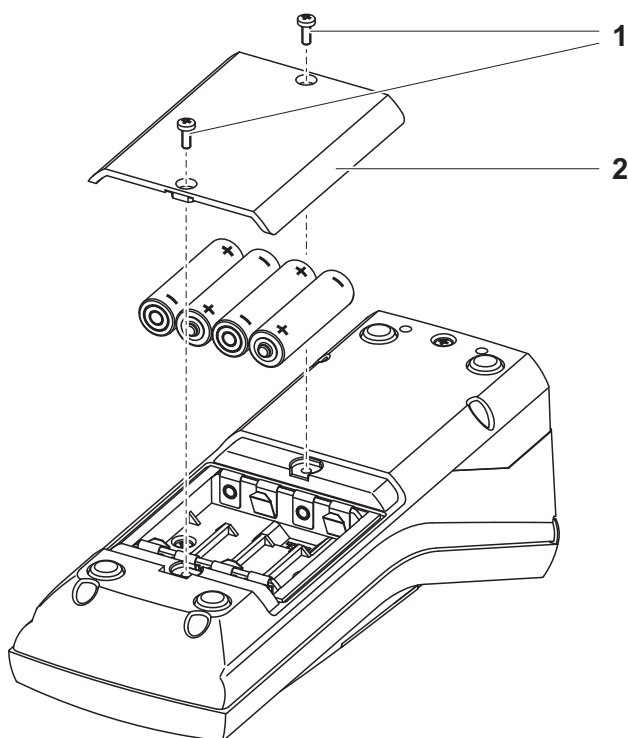

- 1 Open the battery compartment:
 - Unscrew the two screws (1) on the underside of the meter,
 - Remove the lid of the battery compartment (2).
- 2 If necessary, take four old batteries out of the battery compartment.
- 3 Insert four batteries (3) in the battery compartment.
- 4 Close the battery compartment and fix it with the screws.

3.3 Initial commissioning

Perform the following activities:

- For
 - Battery operation: Insert the batteries (see section 3.2.2)
 - Battery pack operation: Insert the battery pack (see section 5.1.2)
 - Line power operation and charging the battery pack: Connect the power pack (see section 3.2)
 - Operation with LabStation and battery pack: Insert the battery pack, connect the LabStation and insert the meter in the LabStation (see LabStation operating manual)
- Switch on the meter (see section 4.1)
- Set the language as necessary (see section 4.3.3)
- Set the date and time as necessary (see section 4.3.4)



When you set the language, date and time according to the mentioned sections of this operating manual you will quickly become familiar with the simple operation of the pHotoFlex® pH.

4 Operation

4.1 Switching on the meter

Switching on

Press the **<ON/OFF>** key.

For 30 seconds, the *Start* menu appears with a selection of the measuring modes. The measuring mode last selected is highlighted.

The status line indicates the meter designation and the version number of the software.

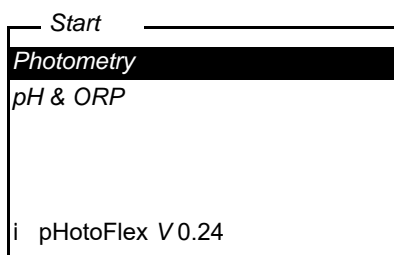

After a few seconds, the meter automatically switches to the measuring mode and measured parameter used last.

The measured value display appears (here, e.g. measuring mode *Photometry*).

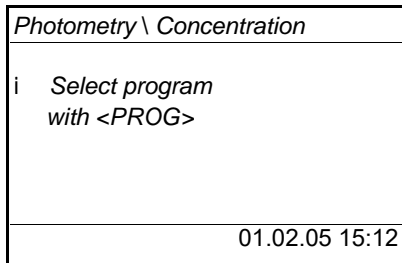

Press **<M>** (long pressure) to switch to the measuring mode.

Press **<M>** (short pressure) to switch between different measuring parameters in the selected measuring mode.

Switching off

Press the **<ON/OFF>** key.

Automatic switch-off function

The meter has an automatic switch-off function in order to save the batteries or battery pack (see section 4.4). The automatic switchoff switches off the meter if no key is pressed for an adjustable period.

The automatic switch-off function is not active

- if the power is supplied by the power pack (optional),
- if the power is supplied by the LabStation (optional),
- if the *Timer* or *Analysis timer* function is on.

Display illumination with battery-powered operation

During operation with batteries or battery pack the meter automatically switches off the display illumination if no key is pressed for 30 seconds. The illumination is switched on with the next keystroke again.

4.2 Inserting a cell

In order to be able to insert cells into the pHotoFlex® pH, the cell shaft must be prepared for holding a cell.

- 1 Push the dust cover (1) upward.
The cell shaft for 28 mm cells is open.
 - Insert a 28 mm cell (see below)
 - Insert a 16 mm cell (see page 18)

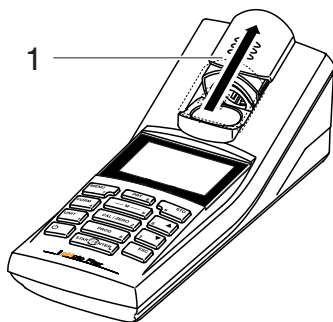
**Inserting a 28 mm cell**

- 2 Insert the cell so that it is positioned on the bottom of the cell shaft.
The cell is ready to be measured.

**Inserting a 16 mm cell**

- 1 Put the fold-out cell shaft (2) in an upright position until it locks into place.

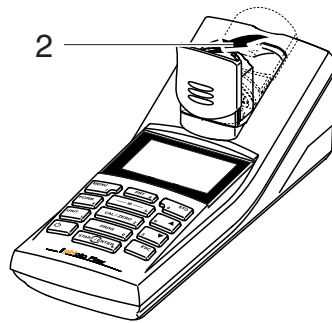

- 2 Pull upwards the height adapter (3).
The cell shaft is extended.

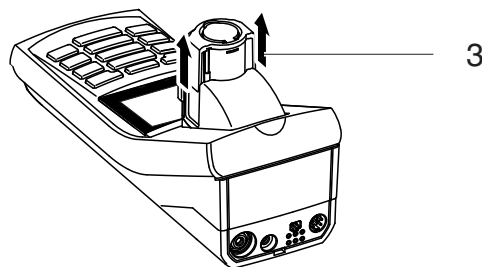

- 3 Open the external light cover (4) of the cell shaft.

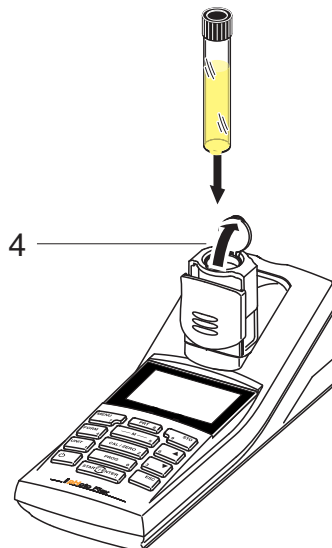

- 4 Insert the 16 mm cell (marking points to the front) so that it is positioned on the bottom of the cell shaft.
- 5 Close the external light cover (4).
The cell is ready to be measured.



For optimum measurement results, the cell must always be covered by the external light cover. Otherwise, the external light can falsify the measurement result.

4.3 General operating principles

This section contains basic information on the operation of the pHotoFlex® pH.

Operating elements, display

An overview of the operating elements and the display is given in section 1.2 and section 1.3.

Operating modes, navigation

An overview of the operating modes of the pHotoFlex® pH and the navigation through menus and functions can be found in section 4.3.1 and section 4.3.2.

4.3.1 Operating modes

The instrument has the following operating modes:

- Measurement
The display indicates measurement data in the measured value display
- Calibration
The display indicates a calibration process with calibration information, or a process to carry out a zero adjustment
- Data transmission
The meter transmits measuring datasets or calibration records to the serial interface
- Configuration
The display indicates a menu with further menus, settings and functions

4.3.2 Navigation

Measured value display

In the measured value display, you can

- select a measuring mode with **<M>** (long pressure)
- select a measured parameter in the active measuring mode (e. g. pH <-> mV) with **<M>** (short pressure)
- open the menu with **<MENU>**
- switch to the superordinate *Start* menu with **<ESC>**.

Menus and dialogs

The menus for settings and dialogs in procedures contain further subelements. The selection is done with the keys **<▲ > <▼ >**.

The current selection is displayed inverse.

- Menus

The name of the menu is displayed at the upper edge of the frame. Menus are opened by confirming with **<START/ENTER>**. Example:

Configuration	
Photometry	
pH & ORP	
System	
Info	

- Settings

Settings are indicated by a colon. The current setting is displayed on the right-hand side. With **<START/ENTER>**, the selection of the possible settings is opened. Subsequently, the setting can be changed with **<▲ > <▼ >** and **<START/ENTER>**.

Example:

System	
Language:	Deutsch
Beep:	Off
Illumination:	On
Contrast:	48 %
Temperature unit:	°C
Switchoff time:	30 min

- Functions

Functions are designated by the name of the function. They are immediately carried out when you confirm them with **<START/ENTER>**.

Example: display the *Calibr. record* function (in the *pH & ORP / Calibration* menu).

pH & ORP	
Calibr. record	
Calibr. type:	AutoCal
TEC	
Calibr. interval:	007 d
Unit for slope:	mV/pH
i 2.00 4.01 7.00 10.01	

- Messages
Information or operating instructions are designated by the *i* symbol. They cannot be selected.
Example:

pH & ORP	
i Buffer recognition TEC	
i Immerse sensor in buffer 1	
Set temperature: 25 °C	
Continue	

← The *i* indicates info texts, e.g. messages, notes or instructions



The principles of navigation are explained in the two following sections by reference of examples:

- Setting the language (section 4.3.3)
- Setting the date and time (see section 4.3.4).

Entering numerals with the number keys

Keys with additional characters printed on (orange) are assigned doubly. In the input fields you can directly enter digits with the orange number keys (e.g. date and time). Complete entering a number with the key **<START/ENTER>**.

When entering numeric values with decimal separators (e.g. turbidity nominal values), pressing **<START/ENTER>** for the first time will set the decimal separator. Pressing **<START/ENTER>** for the second time will complete the entering of the numeric value. The numeric value is always displayed with decimal places and, if necessary, rounded.

4.3.3 Navigation example 1: Setting the language



The following example describes in the language of the country how to set the language. On delivery, English is set as the language in the pHotoFlex® pH. During initial commissioning, you can set the language in the menu, *Configuration / System / Language*.

- 1 In the measured value display:
Open the *Configuration* menu with **<MENU>**.
The instrument is in the configuration mode.
- 2 Select the *System* menu with **<▲ > <▼ >**.
The current selection is displayed in reverse video.
- 3 Using **<START/ENTER>**, open the *System* menu.

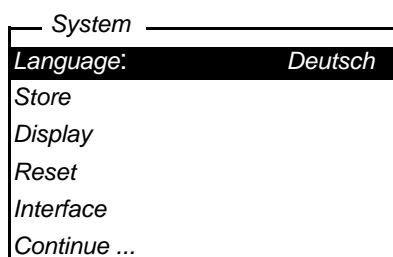

- 4 Select the *Language* menu with **<▲ > <▼ >**.
The current selection is displayed in reverse video.
- 5 Open the setting of the *Language* with **<START/ENTER>**.

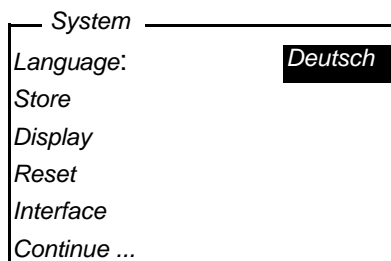

- 6 Select the required language with **<▲ > <▼ >**.
- 7 Confirm the setting with **<START/ENTER>**.
The setting is active. The menu is displayed in the selected language.
- 8 To make further settings, switch to the next higher menu level with **<ESC>**.
or
Switch to the measured value display with **<M>** (short pressure).
The instrument is in the measuring mode.

4.3.4 Example 2 on navigation: Setting the date and time

The meter has a clock with a date function. The date and time are indicated in the status line of the measured value display. When storing measured values and calibrating, the current date and time are automatically stored as well.

Numerals are generally entered via the number keys.

The correct setting of the date and time and date format is important for the following functions and displays:

- Current date and time
- Calibration date
- Identification of stored measured values.

Therefore, check the time at regular intervals.



After a fall of the supply voltage (empty batteries, empty battery pack), the date and time are reset to 01.01.2003 00, 00:00 hours.

Setting the date, time and date format

The date format can be switched from the display of day, month, year (*dd.mm.yy*) to the display of month, day, year (*mm/dd/yy* or *mm.dd.yy*).

- 1 In the measured value display:
Open the *Configuration* menu with **<MENU>**.
The instrument is in the configuration mode.
- 2 Select and confirm the *System / Continue ... / Date/time* menu with **<▲ >** **<▼ >** and **<START/ENTER>**.

<i>Date/time</i>	
<i>Time:</i>	14:53:40
<i>Date:</i>	30.10.03
<i>Date format:</i>	<i>dd.mm.yy</i>

- 3 Select and confirm the *Time* menu with **<▲ >** **<▼ >** and **<START/ENTER>**.
A display for the entry of numerals with the number keys opens up.

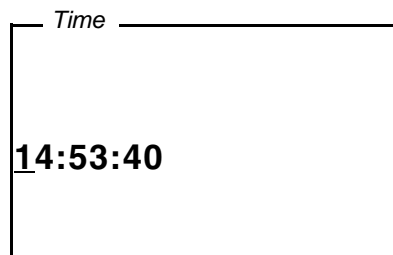

- 4 Enter the time using the number keys.
The digit to be changed is displayed underlined.



In the case of wrong entries, you can cancel the procedure with **<ESC>**.

After canceling with **<ESC>**, it is possible to enter all digits once again. The new digits are only taken over by confirming with **<START/ENTER>**.

- 5 Confirm the setting with **<START/ENTER>**.
The time is set.
- 6 Set the current *Date* as necessary. The setting is made similarly to that of the time.
- 7 Change the date format as necessary.
- 8 To make further settings, switch to the next higher menu level with **<ESC>**.
or
Switch to the measured value display with **<M>** (short pressure).
The instrument is in the measuring mode.

4.3.5 Menu overview

<i>Photometry</i>	<i>Meas. param.</i>	<i>Concentration</i> <i>% Transmission</i> <i>Absorbance</i>		
	<i>Programs</i>			
	<i>Dilution</i>			
	<i>Analysis timer</i>	<i>On</i> <i>Off</i>		
	<i>Reset</i>			
<i>pH & ORP</i>	<i>Meas. param.</i>	<i>pH</i> <i>ORP</i>		
	<i>Calibration</i>	<i>Calibr. record</i>		
		<i>Calibr. type</i>	<i>TEC</i> <i>NIST/DIN</i>	
		<i>Calibr. interval</i>	1 ... 999 d	
		<i>Unit for slope</i>	mV/pH %	
	<i>Man. temperature</i>	-20 ... +130 °C		
	<i>Temperature unit</i>	°C, °F		
<i>Reset</i>				
<i>Timer</i>				

(continued on next page)

<i>System</i>	<i>Language</i>	<i>Deutsch</i> <i>English</i> <i>Français</i> <i>Español</i>		
	<i>Measured value memory</i>	<i>Display</i>		
		<i>RS232 download</i>		
		<i>Data filter</i>	<i>Filter ID</i> <i>PROG</i> <i>Datum</i>	
		<i>Delete</i>		
		i 4 of 1000 i <i>occupied</i>		
		i <i>Filter: No filter</i>		
	<i>Display</i>	<i>Illumination</i>	<i>Auto off</i> <i>On</i> <i>Off</i>	
		<i>Contrast</i>	0 ... 100 %	
		<i>Brightness</i>	0 ... 100 %	
	<i>Reset</i>			
	<i>Interface</i>	<i>Baud rate</i>	1200, 2400, 4800, 9600, 19200	
		<i>Output format</i>	<i>ASCII</i> <i>CSV</i>	
	<i>Continue ... / Date/time</i>	<i>Time</i>	hh:mm:ss	
		<i>Date</i>		
<i>Date format</i>		<i>dd.mm.yy</i> <i>mm.dd.yy</i> <i>mm/dd/yy</i>		
<i>Continue ... / Switchoff time</i>	10, 20, 30, 40, 50 min, 1, 2, 3, 4, 5, 10, 15, 20, 24 h			
<i>Continue ... / Beep</i>	<i>On</i> <i>Off</i>			

Info

4.4 System settings (System menu)

The following meter characteristics and general functions are in the menu *Configuration / System*:

- Language selection (*Language*)
- Memory- and database functions (*Store*)
- Display settings (*Display*)
- Restoring the basic settings (*Reset*)
- Configuration of the interface for PC/printer (*Interface*)
- Setting the date/time (*Date/time*)
- Setting the switch-off time (*Switchoff time*)
- Setting the keyboard sound (*Beep*)

Settings/functions

The settings are in the menu, *Configuration / System*. Move to the *Configuration* menu with the **<MENU>** key.

Menu item	Setting	Explanation
<i>Language</i>	<i>Deutsch</i> <i>English</i> <i>Français</i> <i>Español</i>	Select the language (see section 4.3.3)
<i>Store</i>	<i>Display</i> <i>RS232 down-load</i> <i>Data filter</i> <i>Delete</i>	Memory- and database functions (see section 4.7.2)
<i>Display</i>	<i>Illumination</i> <i>Contrast</i> <i>Brightness</i>	Switch on/off the display illumination (see section 4.4.2)
<i>Reset</i>	-	Reset the system settings to the delivery condition (see section 4.9.1).
<i>Interface</i>	<i>Baud rate</i> <i>Output format</i>	Baud rate of the data interface (see section 4.4.3)
<i>Continue ... / Date/time</i>	<i>Time</i> <i>Date</i> <i>Date format</i>	Time and date settings (see section 4.3.4)

Menu item	Setting	Explanation
<i>Continue ... / Switchoff time</i>	10, 20, 30, 40, 50 min, 1, 2, 3, 4, 5, 10, 15, 20, 24 h	The automatic switchoff function switches the meter off if no entry is made for a specified period of time (<i>Switchoff time</i>). This conserves the batteries or the battery pack.
<i>Continue ... / Beep</i>	<i>On</i> <i>Off</i>	Switches on/off the beep on keystroke

4.4.1 Measured value memory

In the *Measured value memory* menu, you find functions to display and edit the stored measurement datasets:

- Show measurement datasets on the display (*Display*)
- Output measurement datasets to the RS232 interface (*RS232 download*)
- Define filter rules for the stored measurement datasets (*Data filter*)
- Erase all stored measurement datasets (*Delete*)
- Information on the number of occupied memory locations

The settings are in the menu, *Configuration / System / Measured value memory*. Move to the *Configuration* menu with the **<MENU>** key.

Settings/functions

Menu item	Setting/ function	Explanation
<i>Display</i>	-	Displays in pages all measurement datasets that correspond to the filter settings. Further options: <ul style="list-style-type: none"> ● Scroll through the datasets with <▲ > <▼ >. ● Output the displayed dataset to the interface with <PRT>. ● Quit the display with <ESC>.
<i>RS232 download</i>	-	Downloads to the interface all measurement datasets that correspond to the filter settings. The download is ordered according to the date and time. The process can take several minutes. To terminate the process prematurely, press <ESC> .

Menu item	Setting/ function	Explanation
<i>Data filter</i>	see section 4.7.2	Allows to set filter criteria in order to display and download datasets to the interface.
<i>Delete</i>	-	Erases the entire contents of the measuring data memory, independent of the filter settings. Note: All calibration data remain stored when this action is performed.

All details on the subjects of memory and stored data are given in section 4.7.2.

4.4.2 Display

In the *Configuration / System / Display* menu, you set the display features:

- Switching on/off the display illumination (*Illumination*)
- Display contrast (*Contrast*)

The settings are in the menu, *Configuration / System / Display*. Move to the *Configuration* menu with the **<MENU>** key.

Settings

Menu item	Setting	Explanation
<i>Illumination</i>	<i>Auto off</i>	The display illumination switches itself off if no key has been pressed for 30 seconds.
	<i>On</i> <i>Off</i>	Switches the display illumination on or off permanently (see section 4.5.9)
<i>Contrast</i>	0 ... 100 %	Changes the display contrast
<i>Brightness</i>	0 ... 100 %	Changes the display brightness

4.4.3 Interface

In the *Interface* menu, you set the features of the interface.

- Transmission speed (*Baud rate*)
- Output format (*Output format*)

The settings are in the menu, *Configuration / System / Interface*.
Move to the *Configuration* menu with the <MENU> key.

Settings	Menu item	Setting	Explanation
	<i>Baud rate</i>	1200, 2400, 4800, 9600, 19200	Baud rate of the data interface
	<i>Output format</i>	ASCII CSV	Output format for data transmission For details, see section 4.8

4.4.4 Date/time

In the *Configuration / System / Continue ... / Date/time* menu, you set the system clock:

- Current time (*Time*)
- Current date (*Date*)
- Format of the date display (*Date format*)

The settings are in the menu, *Configuration / System / Continue ... / Date/time*.

Move to the *Configuration* menu with the <MENU> key.

Settings	Menu item	Setting	Explanation
	<i>Time</i>	hh:mm:ss	Enter the time with the number keys
	<i>Date</i>		Enter the date with the number keys
	<i>Date format</i>	dd.mm.yy mm.dd.yy mm/dd/yy	Settings of time and date.

4.5 Photometry

4.5.1 General information

Photometric measurements serve to determine chemical substances in liquid samples. For this determination, the substance to be determined has to be present in a form that is suitable for photometric measurement. At the same time, possible disturbing factors have to be excluded.

Before measurement, the sample has to be pretreated in order to bring the

substance to be determined into the form that is suitable for measurement and at the same time exclude disturbing factors.

Pretreatment of the sample is described in the analysis specification.

In a simple case, pretreatment can be to dissolve a solid substance in water; it can, however, also include chemical conversions, e. g. a digestion.

The chemicals required in the analysis specification are available as test sets.



Suitable analysis specifications for test sets can be found in the photometry analysis manual (on CD-ROM).

There you will also find further instructions on handling chemicals and on how to proceed when applying the analysis specifications.

Methods and the corresponding method data for many test sets are stored as programs in the pHotoFlex® pH. A program number is assigned to each program.

The stored method data are loaded when the program number is entered or read in with the aid of a bar code reader.

You can look up an overview of the available methods in the photometry analysis manual and display it on the screen of the pHotoFlex® pH (see section 4.5.8).

You can measure the following parameters with the pHotoFlex® pH:

- *Concentration* [mg/l]
- *% Transmission* []
- *Absorbance* []

Preparatory activities

Perform the following preparatory activities when you want to measure:

- 1 Clean the exterior of the cells before filling them with sample and also before measuring if necessary (see section 5.2.2).
The cells must be absolutely clean and free of scratches.
- 2 For measurement, place the pHotoFlex® pH on a horizontal surface.

4.5.2 Settings for photometric measurements

For photometric measurements, the following settings are available in the *Configuration / Photometry* menu:

- Setting the measured parameter
- Displaying a list of all programs
- Setting the dilution factor
- Switching on or off the analysis timer
- Resetting the settings for photometric measurements

The settings are in the menu, *Configuration / Photometry*. Move to the *Configuration* menu with the **<MENU>** key.

Settings	Menu item	Setting	Explanation
	<i>Meas. param.</i>	<i>Concentration</i> <i>% Transmission</i> <i>Absorbance</i>	Measured parameters in measuring mode <i>Photometry</i>
	<i>Programs</i>		Display all programs with the corresponding program data (see section 4.5.8).
	<i>Dilution</i>		Set the dilution factor (see section 4.5.11)
	<i>Analysis timer</i>	<i>On</i> <i>Off</i>	Switch on/off the analysis timer (see section 4.5.9)
	<i>Reset</i>		Reset all settings for the <i>Photometry</i> measuring mode (see section 4.9.3)

4.5.3 Measuring the concentration

- 1 Press the **<M>** key (long pressure) repeatedly until the *Photometry* measuring mode is selected.
- 2 Press the **<M>** key (short pressure) repeatedly until the measured parameter, *Concentration* is selected.

First concentration measurement with the pHotoFlex® pH

Photometry \ Concentration	
i	Select program with <PROG>
01.02.05 15:12	

Second and all further concentration measurements

Photometry \ Concentration	
i	Select program with <PROG> or with ▲ ▼
83: A6/25 MC	NH4-N
16 mm	0.20 - 6.51 mg/l
01.02.05 15:12	



From the second concentration measurement, the data of the program last used is automatically displayed here.

With <▲ > <▼ > you can quickly switch between the ten programs last used.

To select a program, you can as an alternative also read in the program number of an analysis specification with a bar code reader (see section 8.2). The following step three is skipped. You can directly start measuring.

The program number of the test is given in the analysis specification, in the list of available programs and, with some tests, on the packing of the test (under the bar code).

- 3 Open the *Program number* display with <PROG>, enter the required program number with the number keys and confirm with <START/ENTER>.
or (from the second concentration measurement):
Select a program out of the last ten programs with <▲ > <▼ >. The program data is displayed.



If a program number is selected that requires a measured blank value, the menu automatically guides to the blank value measurement.

Photometry \ Concentration	
i	Insert sample
i	Start measurement with <START>
83: A6/25 MC	NH4-N
16 mm	0.20 - 6.51 mg/l
01.02.05 15:12	

- 4 Insert the cell (see section 4.2).

- 5 Start the measurement with **<START/ENTER>**.
Measurement is started. The result is displayed.

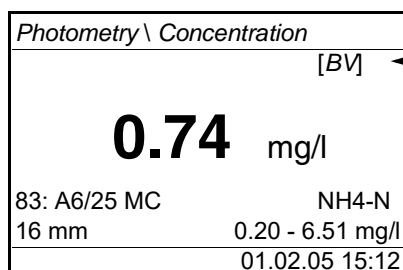

← A blank value measured by the user is used

Display when the measuring range is exceeded or undercut

Display	Meaning
"< [Lower limit of measuring range]" instead of the measured value	Measuring range undercut. <u>Remedy:</u> Select a test with a lower measuring range
"> [Upper limit of measuring range]" instead of the measured value	Measuring range exceeded. <u>Remedy:</u> Select a test with a higher measuring range or dilute the sample
Orientation value	This value serves as an indication for the selection of a suitable test or dilution. If an evaluation of the measurement signal is no longer possible (intensity too high or too low), four bars appear ("----").

Examples:

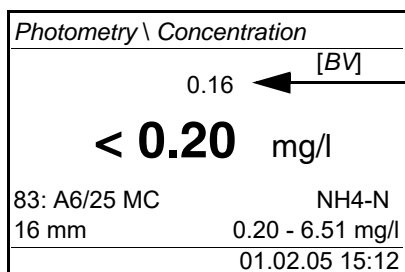

← Orientation value

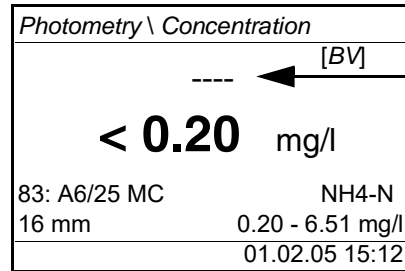

The orientation value can be very inaccurate and should not be used as a measured value!

4.5.4 Blank value (reagent blank value)

A blank value is required for every concentration measurement. For some programs (methods) for concentration measurement, the blank values are already stored in the meter. They are used automatically. For all other programs, the blank value has to be determined separately before the first measurement. Each stored reagent blank value can be replaced by a blank value determined by the user.



You will find more information on blank values in the photometry analysis manual. A table with the programs and required blank values is included in the analysis specifications.

A blank value is always stored for the program that has just been called up. It remains stored until it is erased (menu item, *Delete blank value*) or overwritten.

The *Reset* function erases all blank values measured by the user and restores the blank values stored in the factory.

If a blank value measured by the user is stored for a program, this blank value is used for measurement. The usage of the blank value measured by the user is documented and also indicated in the measured value display.

Blank value measurement

- 1 Press the **<M>** key (long pressure) repeatedly until the *Photometry* measuring mode is selected.
- 2 Press the **<M>** key (short pressure) repeatedly until the measured parameter, *Concentration* is selected.
- 3 Select a program with **<PROG>** as necessary.



The following measurement of the blank value applies only to the selected program. If no program is selected, the information *i No program selected.* appears on the display.

- 4 Open the adjustment menu with **<CAL/ZERO>**.

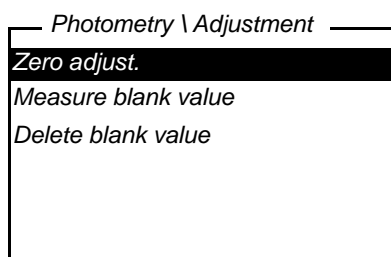

- 5 Using **<▲ >** **<▼ >** and **<START/ENTER>**, select and start the *Measure blank value* function.

The menu-guided blank value measurement begins.
Follow the instructions on the display.

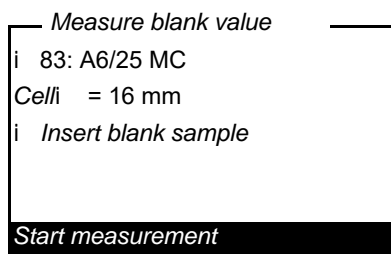

- 6 Insert a cell with blank sample (see section 4.2).
- 7 Start the measurement of the blank value with **<START/ENTER>**.
After measuring, the result of the blank value measurement is displayed and stored.
The result is displayed as *i Blank value measurement successful!*
or *i Blank value measurement erroneous!*

```

— Measure blank value
i 83: A6/25 MC
Celli = 16 mm
i Absorbance = 0.301
i Blank value mea-
surement
successful!

```

- 8 Confirm the result with **<START/ENTER>**.
The blank value measurement is completed.
The meter is ready to measure.
or:
Discard the result with **<ESC>**.
Subsequently, carry out a new blank value measurement.

4.5.5 Standard adjustment (user calibration)

With some of the programs (methods) for concentration measurement, you can optimize the calibration curve stored in the meter with the aid of the *Standard adjustment* function.

A standard adjustment is only valid if the deviation compared to the original calibration is no more than 30%.

A standard adjustment is always stored for the program that is presently called up. A standard adjustment is only deleted if

- a new standard adjustment is carried out
- the standard adjustment is erased manually
- the meter is reset to delivery status (*Reset* function)

Standard adjustment

- 1 If necessary, press the **<M>** key several times until the measured parameter *Concentration* is selected.
- 2 Select a program with **<PROG>** as necessary.



The following measurement of the standard applies only to the selected program.

- 3 Open the *Photometry \ Adjustment* menu with **<CAL/ZERO>**.

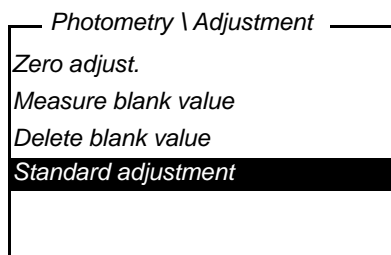

- 4 Open the *Standard adjustment* menu with <▲ > <▼ > and <START/ENTER>.



If data of a standard adjustment are already available, the data of the last standard adjustment are displayed. Here you can also erase the data of an active standard adjustment.

- 5 Using <▲ > <▼ > and <START/ENTER>, select and start the *Measure standard* function.
The menu-guided standard measurement begins.
Follow the instructions on the display.

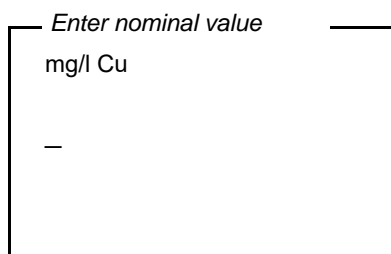

- 6 Enter the nominal value of the standard.
Note:
Enter the decimal separator with <START/ENTER>.
- 7 Confirm the entered nominal value with <START/ENTER>.
- 8 Insert a cell with standard (see section 4.2).
- 9 Start the measurement of the standard with <START/ENTER>.
After measuring, the result of the standard adjustment is displayed and stored.
As the result, the measured value and the adjustment (in %) or *Error* is displayed.

```

Measure standard
i 304: Cu-1 TP
Celli = 10 mm
i 0.600 mg/l Cu:
  2.000 (93.2%)
Accept

```

- 10 Confirm the result with **<START/ENTER>**.
The standard adjustment is completed.
The meter is ready to measure.
or:
Discard the result with **<ESC>**.
Subsequently, carry out a new standard adjustment.



If a standard adjustment is stored for a program, the standard adjustment is automatically used for measurement. The usage of the standard adjustment is documented together with the measured value and indicated in the measured value display with [Ca].

4.5.6 Absorbance / % Transmission, measuring



The transmission measurement is not described separately in the following example as it operates in exactly the same way as the absorbance measurement. The result of the measurement is displayed in % *Transmission*.

- 1 Press the **<M>** key (long pressure) repeatedly until the *Photometry* measuring mode is selected.
- 2 Press the **<M>** key (short pressure) repeatedly until the measured variable, *Absorbance* or % *Transmission* is selected.

```

Photometry \ Absorbance
i Select cell
  with ▲ ▼
16 mm 610 nm
01.02.05 15:12

```

- 3 Select the cell diameter with **<▲ >** **<▼ >** and confirm with **<START/ENTER>**.
- 4 Select the wavelength with **<▲ >** **<▼ >** and confirm with **<START/ENTER>**.

Photometry \ Absorbance	
i Insert sample	
i Start measurement with <START>	
16 mm	610 nm
01.02.05 15:12	

- 5 Clean the cell (see section 5.2.2).
- 6 Insert the cell (see section 4.2).
- 7 Start the measurement with **<START/ENTER>**.
The measurement result is displayed when the measurement is finished.

Photometry \ Absorbance	
0.532	
16 mm	610 nm
01.02.05 15:12	

4.5.7 Zero adjustment

The zero adjustment, i. e. measuring and storing the absorbance of a cell filled with water, is necessary after the meter is switched on.

Additionally, we recommend to carry out a zero adjustment if the ambient temperature has changed.

Only perform the zero adjustment against distilled water in an optically perfect cell. The zero adjustment must be performed separately for each cell type.

- 1 Press the **<M>** key (long pressure) repeatedly until the *Photometry* measuring mode is selected.
- 2 Press the **<M>** key (short pressure) repeatedly until the measured parameter, *Concentration* is selected.
- 3 Press the **<CAL/ZERO>** key.
The menu for adjustment measurements opens up.

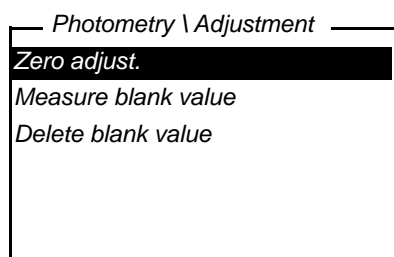

- 4 Using **<▲ >** **<▼ >** and **<START/ENTER>**, select and start the *Zero adjust.* function.
The menu-guided zero adjustment starts.
Follow the instructions on the display.

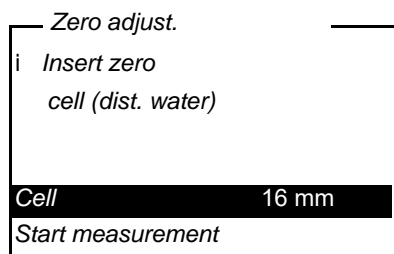

- 5 Insert the cell (see section 4.2).
- 6 Set another cell with **<▲ >** **<▼ >** and **<START/ENTER>** as necessary.
- 7 Start the measurement of the zero adjustment with **<START/ENTER>**.
After measuring, the result of the zero adjustment is displayed and stored.
i *Zero adjust. successful!* (successful zero adjustment) or i *Calibration error!* (zero adjustment not successful) is displayed as the result.
The zero adjustment is completed.



If *i Calibration error!* was displayed as the calibration result, a note automatically reminds you of another zero adjustment before the next measurement.

Measuring is not possible without a valid zero adjustment.

- 8 Confirm the result with **<START/ENTER>**.

The zero adjustment is completed.

The meter is ready to measure.

4.5.8 Programs

Displaying program data

You can view the most important data of all methods.

The method data is ordered according to the program number.

- 1 Open the menu *Configuration/ Photometry/ Programs*.

The display shows the most important data of the selected program.

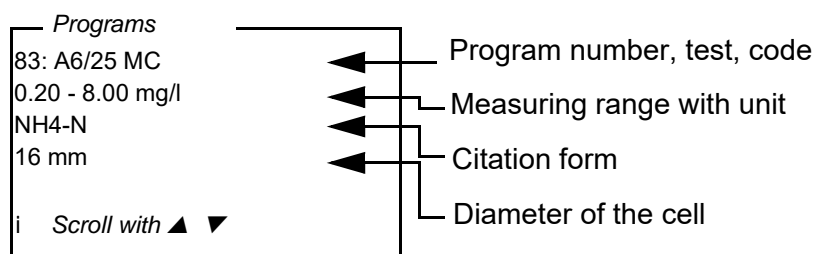

This data is also to be found in the photometry analysis manual in the overview of the test sets and in the individual analysis specifications for the test sets.

Updating programs

Go to www.xylyanalytics.com to always find the latest software version with the newest programs and method data for your pHotoFlex® pH (see FIRMWARE UPDATE).

User-defined programs

User-defined programs (methods) can be stored under program numbers between 900 and 999. You can store up to 100 user-defined programs (see section 4.12).

4.5.9 Analysis timer

Measuring according to analysis instructions often means there are waiting periods between the individual steps.

These waiting periods (time intervals) are stored in the instrument with the

program data for each program. The active *Analysis timer* function automatically reminds you to observe these time intervals by means of the menu guidance.

If you want to manually enter time intervals, use the *Timer* function (see section 4.5.10).

The *Analysis timer* with the required time interval is automatically displayed at the due point.

Start the *Analysis timer* with the **<START/ENTER>** key.

Shortening the time interval is not possible.

An acoustic signal sounds when the adjusted time interval has expired.

The *Analysis timer* function is switched on or off in the *Configuration / Photometry/Analysis timer* menu.

This setting generally applies to all measurements with methods according to analysis specification.

4.5.10 *Timer*

When measuring according to analysis specifications, waiting periods often have to be kept between individual steps of the method.

With the *Timer* function you manually set a time interval.

If you want to be automatically reminded of the given time intervals, use the *Analysis timer* function (see section 4.5.9).

The timer is displayed in the measured value display. It always displays the remaining time of the adjusted time interval.

When the adjusted time interval has expired, the timer indicates 00:00:00, and an acoustic signal sounds.

The *Timer* function is started in the *Configuration / Timer* menu by entering a time interval.

4.5.11 Measuring diluted samples

If the concentration of a test sample exceeds the measuring range of a method, you can dilute the sample by a factor 1 ... 99 so that the concentration of the diluted test sample is within the measuring range of the method (see photometry analysis manual). Thus a valid measurement is possible.

After entering the factor for the dilution the meter converts the concentration to that of the undiluted sample.

The display then indicates the measured value of the undiluted sample.

Entering the factor of the dilution

- 1 Select the program for which a dilution factor is to be entered.

- 2 Open the menu *Configuration/ Photometry / Dilution*.
The current factor of the dilution is displayed.

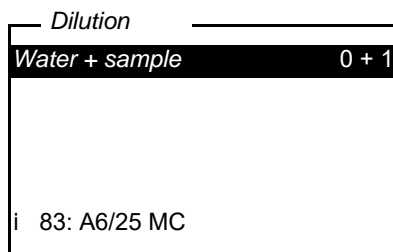

- 3 Open the display for the entry of numerals with **<START/ENTER>**.
- 4 Enter the factor of the dilution with the number keys.
The factor has to be a whole number between 0 ... 99.
- 5 Confirm the factor with **<START/ENTER>**.
- 6 Exit the *Dilution* menu with **<ESC>**.
For the following measurements with the selected program, the concentration of the undiluted sampled is displayed as the measurement result.

The entered dilution factor is only valid for the selected program. The dilution factor is erased if

- the photometer is switched off
- a different program number is selected
- the factor 0 is entered in the *Dilution* menu.

If a dilution factor is active, it is indicated on the display during measurement in the form [x + 1].

4.6 pH value / ORP voltage

4.6.1 General information

You can measure the following parameters:

- pH value []
- ORP [mV]



The RS232 interface is not galvanically isolated.

When connecting an earthed PC/printer, measurements cannot be performed in earthed media as incorrect values would result!

Temperature measurement

For reproducible pH measurements, it is essential to measure the temperature of the test sample.

You have the following options to measure the temperature:

- Automatic measurement of the temperature by a temperature sensor (NTC30 or Pt1000) integrated in electrode.
- Manual determination and input of the temperature.

The measuring instrument recognizes whether a suitable electrode is connected and automatically switches on the temperature measurement.

The display of the temperature indicates the active temperature measuring mode:

Temperature sensor	Resolution of the temp. display	Temperature of the measuring medium
yes	0.1 °C	Automatic measurement
-	1 °C	Manual measurement and entry

Preparatory activities

Perform the following preparatory activities when you want to measure:

- 1 Connect a pH or ORP electrode to the meter.
- 2 Press the **<M>** key (long pressure) repeatedly until the *pH* & *ORP* measuring mode is selected.
- 3 Press the **<M>** key (short pressure) repeatedly until the measured parameter, *pH* or *ORP* is selected.
- 4 Adjust the temperature of the solutions and measure the current temperature if the measurement is made without a temperature sensor.
- 5 Calibrate or check the meter with the electrode.

4.6.2 Measuring the pH value

- 1 Perform the preparatory activities according to section 4.6.1.
- 2 Immerse the pH electrode in the test sample.

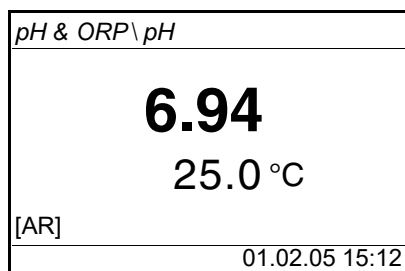

- 3 Press the **<M>** key (short pressure) repeatedly until the measured parameter *pH* is selected.

AutoRead (drift control)

The AutoRead function (drift control) continually checks the stability of the measurement signal. The stability has a considerable impact on the reproducibility of measured values. The display of the measured parameter flashes until a stable measured value is available.

Criteria

With identical measurement conditions, the following applies:

Measured parameter	Reproducibility	Response time
pH value	Better than 0.01	> 30 seconds

4.6.3 Measuring the ORP



ORP electrodes are not calibrated. However, you can check ORP electrodes using a test solution.

- 1 Perform the preparatory activities according to section 4.6.1.
- 2 Immerse the ORP electrode in the test sample.

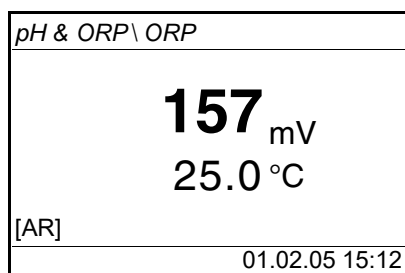

- 3 Press the **<M>** key (short pressure) repeatedly until the measured parameter, *ORP* is selected.

AutoRead (drift control)

The AutoRead function (drift control) continually checks the stability of the measurement signal. The stability has a considerable impact on the reproducibility of measured values. The display of the measured parameter flashes until a stable measured value is available.

Criteria

With identical measurement conditions, the following applies:

Measured parameter	Reproducibility	Response time
ORP	better than 1 mV	> 30 seconds

4.6.4 Settings for pH and ORP measurements

Overview

For pH and ORP measurements, the following settings are possible in the menu *Configuration / pH & ORP*:

- *Meas. param.*
- *Calibr. record* (display, print)
- Select the calibration type
- Enter the *Calibr. interval*
- Select *Unit for slope*
- Select *Temperature unit*
- *Reset*

Settings/functions

The settings are in the menu, *Configuration / pH & ORP*. Move to the *Configuration* menu with the **<MENU>** key.

Menu item	Possible setting	Explanation
<i>Meas. param.</i>	<i>pH & ORP</i> mV	
<i>Calibration / Calibr. record</i>	-	Display the calibration record of the last calibration.
<i>Calibration / Calibr. type</i>	<i>TEC</i> <i>NIST/DIN</i>	Buffer sets to be used for pH calibration. For details, see section 4.6.5.

Menu item	Possible setting	Explanation
<i>Calibration / Calibr. interval</i>	1 ... 999 d	<i>Calibr. interval</i> for the pH electrode (in days). The meter reminds you to calibrate regularly by the flashing sensor symbol in the measured value display.
<i>Calibration / Unit for slope</i>	mV/pH %	Unit of the slope. The % display refers to the Nernst slope of -59.16 mV/pH (100 x determined slope/Nernst slope).
<i>Man. temperature</i>	-20 ... +130 °C	Entry of the manually determined temperature. For measurements without temperature sensor only.
<i>Temperature unit</i>	°C, °F	Degrees Celsius Degrees Fahrenheit
<i>Reset</i>		Reset all settings for the <i>pH</i> & <i>ORP</i> measuring mode (see section 4.9.3)

4.6.5 Calibration

Why calibrate?

pH electrodes age. This changes the asymmetry (zero point) and slope of the pH electrode. As a result, an inexact measured value is displayed. Calibration determines the current values of the asymmetry and slope of the electrode and stores them in the measuring instrument. Thus, you should calibrate at regular intervals.

When to calibrate?

- After connecting another combination electrode
- When the sensor symbol flashes:
 - After the calibration interval has expired
 - after voltage interruption (e.g. empty batteries, empty accumulator pack)

Buffer sets for calibration

You can use the buffer sets quoted in the table for an automatic calibration. The pH values are valid for the specified temperature values. The tempera-

ture dependence of the pH values is taken into account during calibration.

Buffer set	Name on the display	pH values at 25 °C
WTW Technical buffer solutions	TEC	2.00 4.01 7.00 10.01
NIST/DIN buffer solutions	NIST/DIN	1.679 4.006 6.865 9.180 12.454



The buffers are selected in the menu *Configuration / pH & ORP / Calibr. type*, see section 4.6.4).

Calibration points

Calibration can be performed using one, two or three buffer solutions in any order (single-point, two-point or three-point calibration). The meter determines the following values and calculates the calibration line as follows:

	Determined values	Displayed calibration data
1-point	Asy	<ul style="list-style-type: none"> ● Asymmetry = Asy ● Slope = Nernst slope (-59.16 mV/pH at 25 °C)
2-point	Asy Slp.	<ul style="list-style-type: none"> ● Asymmetry = Asy ● Slope = Slp.
3-point	Asy Slp.	<ul style="list-style-type: none"> ● Asymmetry = Asy ● Slope = Slp. <p>The calibration line is calculated by linear regression.</p>



You can display the slope in the units, mV/pH or % (see section 4.6.4).

AutoRead

In calibration, the AutoRead function is automatically activated. The current AutoRead measurement can be terminated at any time (accepting the current value).

Calibration record

When finishing a calibration, the new calibration values are displayed as an informative message (symbol i) first. You can then decide whether to take over these values for the new calibration or to go on using the old calibration data. After the new calibration values have been taken over the calibration record is displayed.

Display calibration data and output to interface

You can view the data of the last calibration on the display. Using the **<PRT>** key, you can then download the displayed calibration data to the interface, e. g. to a printer or PC.

The calibration record of the last calibration is to be found under the menu item, *Configuration / pH & ORP / CalibrationCalibr. record.*

Sample record



```

31.10.03 16:13
pHotoFlex Ser. no. 12345678
Calibration pH & ORP
Calibr. date 31.10.03 16:13:33
Calibr. interval 7 d
AutoCal TEC
Buffer 1      4.01
Buffer 2      7.00
Buffer 3     10.01
Voltage 1     184.0 mV    24.0 °C
Voltage 2      3.0 mV     24.0 °C
Voltage 3    -177.0 mV     24.0 °C
Slope        -60.2 mV/pH
Asymmetry     4.0 mV
Sensor +++

```

Calibration evaluation

After calibrating, the meter automatically evaluates the calibration. The asymmetry and slope are evaluated separately. The worse evaluation of both is taken into account. The evaluation appears on the display and in the calibration record.

Display	Calibration record	Asymmetry [mV]	Slope [mV/pH]
	+++	-15 ... +15	-60,5 ... -58
	++	-20 ... +20	-58 ... -57
	+	-25 ... +25	-61 ... -60.5 or -57 ... -56

Display	Calibration record	Asymmetry [mV]	Slope [mV/pH]
 Clean the electrode according to the electrode operating manual	-	-30 ... +30	-62 ... -61 or -56 ... -50
----	----	< -30 or > 30	... -62 or ... -50
Perform error elimination according to chapter 6 WHAT TO DO IF...			

Preparatory activities

Perform the following preparatory activities when you want to calibrate:

- 1 Connect the pH electrode to the meter.
The pH measured value is shown on the display.
- 2 Keep the buffer solutions ready. Adjust the temperature of the buffer solutions, or measure the current temperature, if you measure without a temperature sensor.

4.6.6 Carrying out the TEC and NIST/DIN calibration

The two calibration procedures only differ in the use of different buffer sets (see section 4.6.5). Make sure that, in the *pH & ORP / Calibration* menu, the *Calibr. type* is correctly set (see section 4.6.4).

For this procedure, use any two or three WTW Technical buffer solution in ascending or descending order.

Below, the *TEC* calibration is described. With *NIST/DIN* calibration, the *NIST/DIN* buffer recognition and other buffer nominal values are displayed. Apart from that, the procedure is identical.



The TEC calibration at pH 10.01 is optimized for the WTW Technical buffer solution TEP 10 Trace or TPL 10 Trace. Other buffer solutions could cause the calibration to be erroneous. The correct buffer solutions are available in the WTW catalog or on the Internet.

- 1 Press the **<M>** key (short pressure) repeatedly until the measured parameter, *pH* or *ORP* is selected.

- 2 Start the calibration with **<CAL/ZERO>**.
The calibration display appears.

```

pH & ORP \ Calibration
i Buffer recognition TEC
i Immerse sensor in buffer 1

Continue

```

- 3 Immerse the electrode in buffer solution 1.
- 4 If the *Set temperature* menu item appears, measure and enter the temperature of the buffer manually (measurement without temperature sensor).
- 5 Using **<▲ >** **<▼ >** *Continue*, highlight and press **<START/ENTER>**.
The buffer is measured.
The measured value is checked for stability (AutoRead).

```

pH & ORP \ Calibration
i Buffer value = 7.00
i U = 3 mV
i Temperature = 24.8°C
████████████████████
Terminate AutoRead

```

- 6 Wait for the end of the AutoRead measurement or accept the calibration value with **<START/ENTER>**.
The calibration display for the next buffer appears.

```

pH & ORP \ Calibration
i Buffer recognition TEC
i Immerse sensor in buffer 2

Exit with one point calibr.
Continue

```

- 7 Single-point calibration: Using <▲ > <▼ >, select *Exit with one point calibr.* and confirm with <START/ENTER>.

The calibration is completed as a single-point calibration.

The new calibration values are displayed as a piece of information (i).

You have the following options:

- Using <START/ENTER>, take over the new calibration values. Subsequently, the calibration record is displayed and output to the interface at the same time.
- Using <M> (short pressure) or <ESC> switch to the measured value display, without taking over the new calibration values.



For **single-point calibration**, the instrument uses the Nernst slope (-59.16 mV/pH at 25 °C) and determines the asymmetry of the electrode.

Continuing for two-point calibration (Calibr. type TEC)

- 8 Thoroughly rinse the electrode with distilled water.
- 9 Immerse the electrode in buffer solution 2.
- 10 If the *Set temperature* menu item appears, measure and enter the temperature of the buffer manually (measurement without temperature sensor).
- 11 Using <▲ > <▼ > *Continue*, highlight and press <START/ENTER>. The buffer is measured. The measured value is checked for stability (AutoRead).

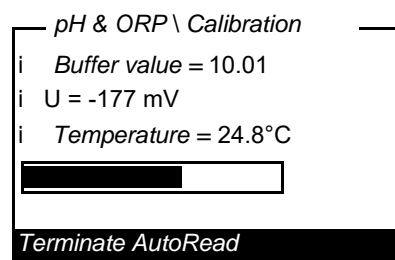

- 12 Wait for the end of the AutoRead measurement or and accept the calibration value with <START/ENTER> *Terminate AutoRead* . The calibration display for the next buffer appears.

```

pH & ORP \ Calibration
i Buffer recognition TEC
i Immerse sensor in buffer 3

Exit with 2 point calibr.
Continue

```

- 13 For two-point calibration, select with **<▲ > <▼ >** *Exit with 2 point calibr.* and confirm with **<START/ENTER>**.

The calibration is completed as a two-point calibration.

The new calibration values are displayed as a piece of information (i).

You have the following options:

- Using **<START/ENTER>**, take over the new calibration values. Subsequently, the calibration record is displayed and output to the interface at the same time.
- Using **<M>** (short pressure) or **<ESC>**, switch to the measured value display, without taking over the new calibration values.

Continuing with three-point calibration (Calibr. type TEC)

- 14 Thoroughly rinse the electrode with distilled water.
- 15 Immerse the electrode in buffer solution 3.
- 16 If necessary, measure the temperature of buffer 3 manually and, using **<▲ > <▼ >** and **<START/ENTER>**, enter and confirm in the *Set temperature* setting.
- 17 Using **<▲ > <▼ >** *Continue*, highlight and press **<START/ENTER>**. The buffer is measured.
The measured value is checked for stability (AutoRead).

```

pH & ORP \ Calibration
i Buffer value = 4.01
i U = 184 mV
i Temperature = 24.8°C
████████████████████
Terminate AutoRead

```

- 18 Wait for the end of the AutoRead measurement or *Terminate Auto-Read* and accept the calibration value with **<START/ENTER>**.

The new calibration values are displayed as a piece of information (i).

You have the following options:

- Using **<START/ENTER>**, take over the new calibration values. Subsequently, the calibration record is displayed and output to the interface at the same time.
- Using **<M>** (short pressure) or **<ESC>** switch to the measured value display, without taking over the new calibration values.

4.7 Memory

The meter has 2000 storage locations for measurement datasets.

You can transmit measured values (datasets) to the data memory with the **<STO>** key.

Each data storing process transmits the current dataset to the interface at the same time.

The number of memory locations that are still free is displayed in the *Store* menu. The number of memory locations that are occupied is displayed in the *System / Measured value memory* menu.

Measurement dataset

A complete dataset consists of:

- Date/time
- ID number (ID)
- and the following measurement data, depending on the selected measuring mode

Measuring mode	Measured data
<i>Photometry:</i>	<ul style="list-style-type: none"> ● Program number ● Measured value ● Citation form ● Use of a blank value (BV) ● Dilution (x +1)

pH & ORP:

- Measured value (pH/mV)
- Temperature value (°C/°F)
- AutoRead info (AR)

AR appears with the measured value if the AutoRead criterion was met while storing (stable measured value). Otherwise, the AR display is missing.

4.7.1 Storing measurement datasets

Proceed as follows to transmit to the data memory and simultaneously output to the interface a measurement dataset:

- 1 Press the **<STO>** key.
The *Store* display appears.

```

—Store (996 free)
i 02.02.2005 11:24:16
  0.00 mg/l PO4-P BV
  PROG 1

ID:                               1
Store (ID: 1)

```

- 2 Using **<▲ >** **<▼ >**, **<START/ENTER>** and the number keys, change and confirm the ID number (*ID*) as necessary (0 ... 999).
- 3 Using **<START/ENTER>** or **<STO>**, confirm *Store*.
The dataset is stored. The meter switches to the measured value display.



A measurement dataset is quickly stored by twice pressing **<STO>**. It is stored with the ID last set.

If the memory is full

You can erase the entire memory (see section 4.7.5), or overwrite the oldest dataset with the next storing procedure.
A security prompt appears before a dataset is overwritten.

4.7.2 Filtering measurement datasets

The functions to display and download stored measurement datasets (see section 4.4.1) refer to all stored measurement datasets that correspond to the specified filter criteria.

The settings are in the menu, *Configuration / System / Measured value memory / Data filter*.

Move to the *Configuration* menu with the **<MENU>** key.

Data filter	Menu item	Setting/function	Explanation
	<i>Filter</i>		Filter criteria:
		<i>No filter</i>	Data filter switched off
		<i>ID</i>	Selection according to ID number
		<i>PROG</i>	Selection according to program
		<i>Datum</i>	Selection according to period
		<i>ID + PROG</i>	Selection according to program and ID number
		<i>ID + Date</i>	Selection according to period and ID number
		<i>PROG + Date</i>	Selection according to program and date
		<i>ID + PROG + Date</i>	Selection according to ID, program and date
	<i>ID</i>		Entry of filter criteria
	<i>PROG</i>		These menu items are made visible by selecting the filter criteria in the <i>Filter</i> menu.
	<i>Datum</i>		

4.7.3 Displaying measurement datasets

You can read out stored datasets to the display. Only those datasets are displayed that correspond to the selected filter criteria (see section 4.7.2).

Start reading out the data to the display in the menu, *Configuration / System / Measured value memory / Display*.

Representation of a dataset

```
02.02.2005 11:24:16
ID: 1
7.000 (pH) 24.8 °C AR
i Scroll with ▲ ▼
```

Further datasets that correspond to the filter criteria are displayed with the <▲ > <▼ > keys.

Quitting the display

To quit the display of stored measurement datasets, you have the following options:

- Switch directly to the measured value display with <M> (short pressure).
- Leave the display and switch to the superordinate menu with <ESC> or <START/ENTER>.

4.7.4 Output measurement datasets to the RS232 interface

You can output stored datasets to the RS232 interface (see section 4.8). Only those datasets are downloaded that correspond to the selected filter criteria (see section 4.7.2).

The datasets are downloaded in the specified output format (see section 4.8.5).

The output of the data to the interface is started in the menu, *Configuration / System / Measured value memory / RS232 download*.

4.7.5 Erasing stored measurement datasets

You can erase the stored measurement datasets altogether if you no longer need them.

Erasing all measurement datasets is done in the menu, *Configuration / System / Measured value memory / Delete*.



Erasing individual datasets is not possible. If all memory locations are occupied, however, it is possible to overwrite the oldest dataset at a time. A security prompt appears before a dataset is overwritten.

4.8 Transmitting data

To transfer data from the pHotoFlex® pH to a PC or printer, first establish a connection to a PC or printer (see section 4.8.1).

With the PC software LS Data you can, without further configuration, transmit or save measurement and calibration data for GLP-compliant data management to LS Data or transmit them to Excel and thus to LIMS (see section 4.8.2).

With the MultiLab® Importer (an add-in for Microsoft Excel) you can transmit data from the meter directly to an open Excel sheet (see section 4.8.3).

The connection to a printer or terminal program has to be configured so data can be safely transmitted (see section 4.8.5).

4.8.1 Establishing the connection to a PC

You have the following possibilities of transmitting data from the pHotoFlex® pH to a PC

- via the RS232 interface of the pHotoFlex® pH
or
- via the RS232 interface of the LabStation LS Flex/430
(accessories, see chapter 8)



The RS232 interface is not galvanically isolated.

When connecting an earthed PC/printer, measurements cannot be performed in earthed media as incorrect values would result.

Prerequisites

- Microsoft Windows PC with one of the following operating systems:
 - Windows 7
 - Windows 8
 - Windows 10.
- Free interface of the PC
 - Serial COM interface
or
 - USB interface:
and USB adapter (accessory)
- Connection to the PC
 - Connecting cable AK 540/B (accessory)
or
 - LabStation LS Flex/430 (accessory, see chapter 8)

Establishing a connection

- 1 Connect the pHotoFlex® pH to the PC via the RS232 or via the LabStation LS Flex/430 (see operating manual LS Flex/430).

The connection to the PC is established. The data can be transferred to the PC:

- via the PC software LS Data (see section 4.8.2)
- via the MultiLab® Importer (see section 4.8.3)
- via a terminal program (see section 4.8.6).

4.8.2 Data transmission with the PC software LS Data

With the PC software LS Data you can transmit and save to the LS Data any measurement- and calibration data for GLP compliant data management (menu item *File / Save As... / *. csv* (CSV format)) or transmit and save to Excel (menu item *Data exchange / Export (.xls)*) and thus transfer to LIMS.



The PC software LS Data is available as an accessory (LabStation LS Flex/430 with PC software LS Data, see chapter 8).

- 1 Establish the connection to a PC (see operating manual of the PC software LS Data and section 4.8.1).
- 2 Transmit data (see operating manual of the PC software LS Data).

4.8.3 Data transmission with the Excel add-in MultiLab® Importer



Set the CSV output format for datasets at the pHotoFlex® pH. It is selected in the menu, *Configuration / System / Interface / Output format* (see section 4.8.4 ESTABLISHING THE CONNECTION TO A PRINTER).

- 1 Establish the connection to a PC (see section 4.8.1).
- 2 Establish a data connection (see operating manual MultiLab® Importer).
- 3 Transmitting data (see section 4.8.6).

4.8.4 Establishing the connection to a printer

Via the RS 232 interface, you can transmit data to an external printer.



The RS232 interface is not galvanically isolated. When connecting an earthed PC/printer, measurements cannot be performed in earthed media as incorrect values would result.

Suitable printers

- P3002 (see section 8 ACCESSORIES AND OPTIONS)
- P3001 (no longer available as accessory)

Socket assignment (RS232)

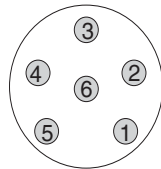

RS 232
REC

- 1 RTS
- 2 RxD
- 3 TxD
- 4 DTR
- 5 SG
- 6 CTS

- 1 Connect the RS232 interface to the external printer with the AK540/S cable.



The pHotoFlex® pH is pre-configured for the connection of the printer.

- 2 For error-free data transmission:

The RS232 interface of the pHotoFlex® pH and the printer have to be set to the same transmission speed (*Baud rate*).

 - The baud rate of the pHotoFlex® pH is selected in the menu *Configuration / System / Interface / Baud rate*.
 - The setting of the baud rate of the printer and the default setting are in the documentation of your printer.
- 3 Selecting the output format of datasets (pHotoFlex® pH)

It is selected in the menu, *Configuration / System / Interface / Output format*.

Examples of the output formats (see section 4.8.6)
- 4 Transmitting data (see section 4.8.6).

Examples of transmitted data (see section 4.8.7)

4.8.5 Configuration for the data transmission to a terminal program

Via the RS232 interface you can also transmit data to a PC with the aid of a so-called terminal program.



When using the terminal program "HyperTerminal", you can load the transfer data automatically with the *.ht file stored on the CD.

- 1 Establish the connection to a PC (see section 4.8.1).
- 2 Determine the output format of datasets at the pHotoFlex® pH (see section 4.8.4 ESTABLISHING THE CONNECTION TO A PRINTER
It is selected in the menu, *Configuration / System / Interface / Output format*.
Examples of the output formats (see section 4.8.6)
- 3 Configure the RS232 interface of the pHotoFlex® pH and the terminal program.
The transmission data specified in the pHotoFlex® pH and terminal program have to match.
 - RS232 interface (see section 4.4.3).
 - Terminal (see operating manual of your terminal).

Transmission data:

Baud rate	can be selected from: 1200, 2400, 4800, 9600, 19200
Handshake	none
Parity	none
Data bits	8
Stop bits	1

- 4 Transmit data (see section 4.8.6).
Examples of transmitted data (see section 4.8.7)

4.8.6 Transmitting data to a printer or terminal program

With a printer connected or a connection to a terminal program existing, you can transmit data in the following ways:

Data	Operation / description
Individual data (e.g. calibration protocol, AQS protocol, measured value)	<ul style="list-style-type: none"> ● Display the data and press <PRT>. The data being shown on the display are transmitted to the interface. ● Simultaneously with every manual storage process.
Stored measured values	<ul style="list-style-type: none"> ● Display the saved data and press <PRT>. ● All datasets according to the filter criteria (section 4.4) via the <i>Ausgabe RS232/USB</i> function (see section 4.7.2.).



With the **<PRT>** key you output data that is being shown on the display to the interface (displayed measured values, stored measurement datasets, calibration record).

4.8.7 Examples of data transmitted (printer, terminal program)

The data are output according to the selected output format.

The ASCII output format delivers formatted datasets.

**Example;
output format
ASCII**

```

pHotoFlex Ser. no. 12345678
31.10.04 09:56:20
ID: 1
10.01 (pH) AR
25 °C

-----

pHotoFlex Ser. no. 12345678
31.10.04 15:48:08
ID 1 / PROG 2
1.1 mg/l Pb [BV][9 + 1]

-----

etc...
```

Example, output format CSV

The CSV output format delivers datasets separated by ";".
The data are output in the following order:

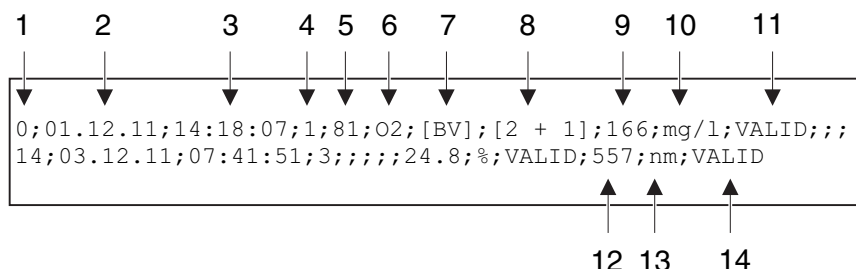

- 1 Current number of the storage location
(or "0" during output from measured value display)
- 2 Date of storing
- 3 Time of storing
- 4 Selected ID
- 5 Program number (only for the measured parameter, *Concentration*)
- 6 Citation form (only for the measured parameter, *Concentration*)
- 7 AR: Measuring mode *pH & ORP*: AutoRead
BV: Measured parameter *Concentration*: Blank value
- 8 Dilution (only for the measured parameter, *Concentration*)
- 9 Main measured value or
Upper/lower measuring range limit
(only with measured value status, OFL/UFL)
- 10 Unit of the main measured value or
designation of dimensionless measured values, e.g. <pH>
- 11 Measured value status of the main measured value
 - * VALID: Measured value valid
 - * INVALID: Measured value invalid
 - * UFL: Measured value below the lower measuring range limit
 - * OFL: Measured value above the upper measuring range limit
- 12 Secondary measured value or standard adjustment
with measured parameter, *pH & ORP*: Temperature
with measured parameter, *Absorbance / % Transmission*:
Wavelength of measurement for the measured parameter,
Concentration: Status standard adjustment [Cal]
- 13 Unit of the secondary measured value
for the measured parameter, *pH & ORP*: °C / °F
with measured parameter, *Absorbance / % Transmission*: nm
- 14 Measured value status of the secondary measured value (see 11)



If the connected external printer does not print, please check whether the same baud rate is set at the pHotoFlex® pH and printer.

4.9 Reset

You can reset (initialize) all system and measurement settings.

4.9.1 Resetting the system settings

With the *System / Reset* function, all resettable settings are reset.

- Settings for *pH & ORP* (see section 4.9.3)
- Settings for *Photometry* (see section 4.9.2)
- System settings

System setting	Default settings
<i>Baud rate</i>	4800 Baud
<i>Output format</i>	ASCII
<i>Illumination</i>	<i>Auto off</i>
<i>Contrast</i>	50 %
<i>Brightness</i>	50 %
<i>Switchoff time</i>	30 min
<i>Beep</i>	<i>On</i>
Measuring mode	<i>Photometry</i>

4.9.2 Resetting the photometry settings

With the *Photometry / Reset* function, all settings are reset.

Setting	Default settings
<i>PROG</i>	0
Cell size	16 mm
<i>Meas. param.</i>	<i>Concentration</i>
Wavelength	436 nm
Blank values	all erased

4.9.3 Resetting the settings for pH measurements



The calibration data are reset to the default settings together with the measuring parameters. Recalibrate after performing a reset.

The following settings for pH measurements are reset to the default settings with the *Reset* function:

Setting	Default settings
<i>Calibr. type</i>	<i>TEC</i>
<i>Calibr. interval</i>	7 d
<i>Meas. param.</i>	<i>pH & ORP</i>
Asymmetry (<i>Asy</i>)	0 mV
Slope (<i>Slp.</i>)	-59.16 mV/pH
Temperature manual	25 °C
Temperature	°C

4.10 Meter information

The following meter information is listed in the *Configuration / Info* menu:

- Model designation
- Software version
- Version number(s) of the stored program data
- Series number of the meter

<i>Info</i>	
i	<i>Model:</i> pHotoFlex
i	<i>Software:</i> V 0.35
i	<i>Prog.:</i> V 0.07
i	<i>Ser. no.:</i> 04280003

4.11 Software update

With a software update you obtain the current software with all new programs and method data (see section 9).

A software update comprises

- new instrument software
- new programs (methods)
- revisions of existing methods

The current software version can be found on the Internet at www.xylemanalytics.com.

The proceeding for updating the software is given in the appendix (see section 9).

4.12 Administrating user-defined methods

User-defined programs can be

- entered
- read out
- erased.

To store user-defined programs (methods) in the meter, determine a calibration line for your method yourself and transmit the data of this calibration line to the pHotoFlex® pH.

Administration of the method data can be carried out in the LSdata software (see LSdata operating manual) or with the aid of a terminal program (see section 4.12.1).

You need the following data in any case:

Data	Possible entries/examples
<i>Program No:</i>	900 ... 999
<i>Model:</i>	Any name (max. 5 characters)
<i>Cuvette [mm]:</i>	16 or 28
<i>Wave length [nm]:</i>	436, 517, 557, 594, 610 or 690
<i>MRB:</i> (measuring range beginning)	e.g. 0.05
<i>MRE:</i> (measuring range end)	e.g. 8.00
<i>E0: (Offset)</i>	e.g. 0.0
<i>Slope: (slope)</i>	e.g. 1.0
<i>Resolution: (resolution)</i>	0.0001, 0.001, 0.01, 0.1, 1, 2, 5, 10 or 100

Data	Possible entries/examples
<i>Formula:</i> (citation form)	e.g. PO4-P (max. 9 characters)
<i>Unit</i> (unit)	e.g. mg/l (max. 7 characters)
<i>Blank required:</i> (No/Yes)	0 or 1
<i>Standard adjustment possible:</i> (No/Yes)	0 or 1
<i>Standard adjustment required:</i> (No/Yes)	0 or 1

4.12.1 Administrating user-defined programs with a terminal program

Generally, a terminal program serves to establish a connection to a device on a data interface and to communicate with the device via a console on the display.

Thus, it is also possible to send command lines.

Terminal programs are available for different operating systems by different manufacturers. Windows (version 95 to XP) contains the "HyperTerminal" terminal program. It is in the program menu under *Accessories*.

For more detailed information please refer to the user information of the terminal program.



On the CD-ROM there is a configuration file for the HyperTerminal program. By double clicking the configuration file (*.ht) you open the HyperTerminal program with the presettings required for data exchange with the meter.

The pHotoFlex® pH can administrate the database of user-defined programs via command lines.

- 1 With the aid of the AK 540/B interface cable, connect the pHotoFlex® pH to the serial interface (COM port) of the PC (see section 8.1.1).
- 2 Make sure the pHotoFlex® pH is switched on.
- 3 Start the terminal program on the PC.
- 4 Configure the connection settings for the COM interface as necessary.

Storing user-defined programs

Enter a command line according to the following scheme in the terminal pro-

gram:

U.500#14, Program No, Model, Cell [mm], Wave length [nm], MRB, MRE, E0, Slope, Resolution, Citation form, Unit, Blank required, Standard adjustment possible, Standard adjustment required

Example:

U.500#14, 900, Test, 16, 436, 0.0, 2.0, 0.0, 1.0, 0.01, test, mg/1, 0, 1, 0

The individual data sections of the command line are separated by commas. The dot "." has to be used as a decimal separator within a data section.

- 5 Enter the command line.
- 6 Finish the command line with Enter.

The data is transmitted to the pHotoFlex® pH.



If there is already a program stored under the selected number, the programming is canceled. If you wish to store the program under the selected number, you have to erase the program stored under the number first.

After a successful transmission, the terminal program writes "!>".
After a failed transmission, the terminal program writes "?>".

Erasing user-defined programs

To erase user-defined programs, enter a command line according to the following scheme in the terminal program:

	Erase all user-defined programs	Erase one user-defined program
Command line	U.520	U.521#1, Program No
Example	U.520	U.521#1, 900

- 7 Enter the command line.
- 8 Finish the command line with Enter.

The data is transmitted to the pHotoFlex® pH.
The requested data is displayed on the terminal as the result.

After a successful transmission, the requested data is displayed on the terminal.
After a failed transmission, the terminal program writes "?>".

Reading out user-defined programs

To read out user-defined programs, enter a command line according to the

following scheme in the terminal program:

	Read out all user-defined programs	Read out one user-defined program
Command line	U.510	U.511#1, <i>Program No</i>
Example	U.510	U.511#1,900

9 Enter the command line.

10 Finish the command line with Enter.

The data is transmitted to the pHotoFlex® pH.

The requested data is displayed on the terminal as the result.

After a successful transmission, the terminal program writes "!>".

After a failed transmission, the terminal program writes "?>".

5 Maintenance, cleaning

5.1 Maintenance

The meter is almost maintenance-free.
The only maintenance task is replacing the batteries or battery pack.

5.1.1 Inserting/exchanging the batteries

NOTE

Make sure that the poles of the batteries are positioned correctly.
The ± signs on the batteries must correspond to the ± signs in the battery compartment.

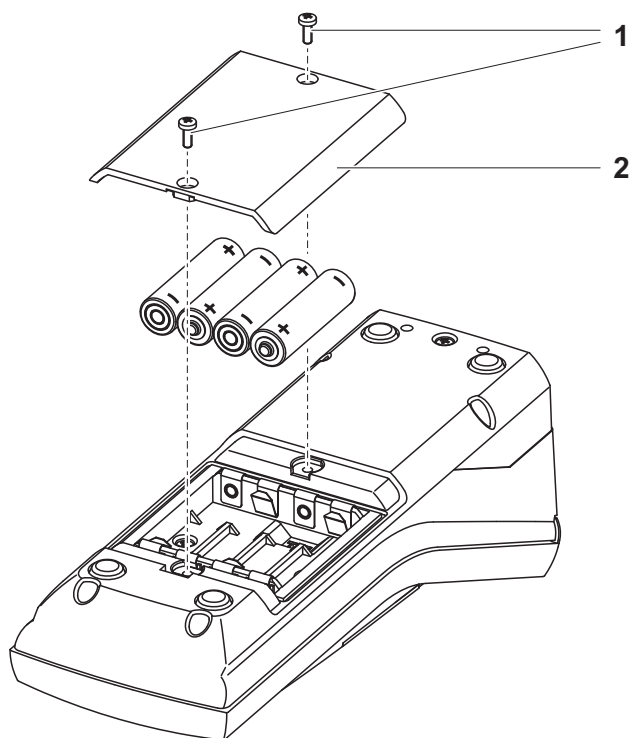

- 1 Open the battery compartment:
 - Unscrew the two screws (1) on the underside of the meter
 - Remove the lid of the battery compartment (2).
- 2 If necessary, take four old batteries out of the battery compartment.
- 3 Insert four batteries (3) in the battery compartment.
- 4 Close the battery compartment and fix it with the screws.



Dispose of used batteries according to the local regulations of your country.

End users within the European Union are obligated to return used batteries (even ecologically compatible ones) to a collection point set up for recycling purposes.

Batteries are marked with the crossed-out waste container symbol. Therefore, they may not be disposed with the domestic waste.

5.1.2 Retrofitting the battery pack

NOTE

Use original WTW battery packs only.

Together with the power pack the battery pack is available as an accessory (see section 8.1).

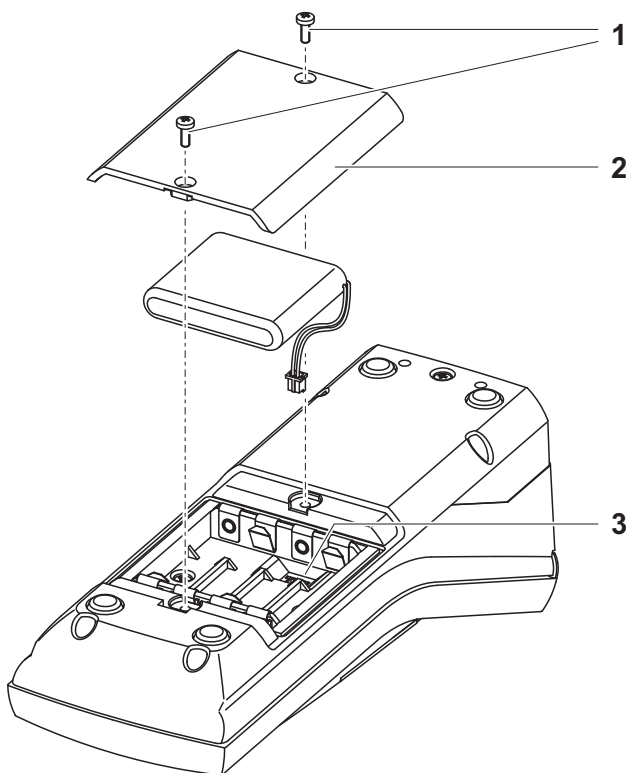

- 1 Open the battery compartment:
 - Unscrew the two screws (1) on the underside of the meter,
 - Remove the lid of the battery compartment (2).

- 2 If necessary, take four old batteries out of the battery compartment.
- 3 Connect the cable of the battery pack with the socket (3) on the bottom of the battery compartment and insert the battery pack in the battery compartment.
- 4 Close the battery compartment and fix it with the screws.



Dispose of used batteries according to the local regulations of your country.

End users within the European Union are obligated to return used batteries (even ecologically compatible ones) to a collection point set up for recycling purposes.

Batteries are marked with the crossed-out waste container symbol. Therefore, they may not be disposed with the domestic waste.

5.2 Cleaning

Occasionally wipe the outside of the measuring instrument with a damp, lint-free cloth. Disinfect the housing with isopropanol as required.

NOTE

The housing parts are made of plastic (polyurethane, ABS and PMMA) and are only conditionally resistant against organic solvents. Thus, avoid contact with acetone and similar detergents that contain solvents. Remove any splashes immediately.

5.2.1 Cleaning the cell shaft

If liquid is in the cell shaft (e.g. due to a spilled cell), clean the cell shaft as follows:



CAUTION

Cells may contain toxic or corrosive substances. If the contents are released, observe the hazard information on the cell. If necessary, take corresponding protective measures (protective goggles, protective gloves etc.).

- 1 Switch the pHotoFlex® pH off and pull out the power plug.
- 2 Rinse the cell shaft with distilled water.

5.2.2 Cleaning the cells

Cells have to be clean, dry, and free of fingerprints. Therefore, clean them regularly:

- 1 Clean the cells inside and out with hydrochloric acid or laboratory soap.
- 2 Rinse several times with distilled water.
- 3 Let them dry in the air.
- 4 Only hold the cells by the top or by the light protection cap so that the optical path is not impaired.
- 5 Before measuring, clean the cell with the enclosed cleaning cloth.

5.3 Packing

This meter is sent out in a protective transport packing.



We recommend: Keep the packing material. The original packing protects the meter against damage during transport.

6 What to do if...

6.1 General errors

Display, LoBat	Cause – Batteries or battery pack almost empty	Remedy – Insert new batteries – Charge the battery pack(see section 3.2)
Meter does not react to keystroke	Cause – Software error – Operating condition undefined or EMC load unallowed	Remedy – Processor reset: Press the < START/ENTER > and < PRT > key simultaneously.
RS232 interface does not react	Cause – Software error – Operating condition undefined or EMC load unallowed	Remedy – Processor reset: Press the < START/ENTER > and < PRT > keys simultaneously.
Error message, Error 0, 8, 16, 16384	Cause – Instrument error	Remedy – Repeat measurement – Meter defective, Send in the meter for repair, stating the error number

6.2 Photometry

Measuring range exceeded or undershot	Cause	Remedy
		– Program not suitable
Obviously incorrect measured values	Cause	Remedy
	– Measurement disturbed by extraneous light	– Close extraneous light flap
	– Cell not correctly inserted	– Insert the cell until it is positioned on the bottom of the cell shaft.
	– Cell contaminated	– Clean the cell
	– Cell shaft contaminated	– Clean the cell shaft
	– Dilution set incorrectly	– Set the dilution
	– Selected program not suitable	– Select a different program
	– Incorrect zero measurement	– Carry out a zero measurement
– Incorrect blank value	– Measure the blank value once again	

6.3 pH value / ORP voltage

Measuring range exceeded or undershot	Cause	Remedy
	<i>Electrode:</i>	
– Air bubble in front of the junction	– Remove the air bubble	
– Air in the junction	– Extract air or moisten junction	
– Gel electrolyte dried out	– Replace the electrode	
<i>Test sample:</i>		
– The pH value lies outside the measuring range	– Not possible	

Measured value display ---- (calibration error)	Cause	Remedy
	<i>Electrode:</i>	
	– Junction contaminated	– Clean the junction
	– Membrane contaminated	– Clean the membrane
	– Moisture in the plug	– Dry plug
	– Too little electrolyte	– Refill the electrolyte
	– Electrode obsolete	– Replace the electrode
	– Electrode broken	– Replace the electrode
	– Socket damp	– Dry the socket
<i>Calibration procedure:</i>		
	– Solution temperature incorrect (without temperature sensor)	– Set the correct temperature
	– Incorrect buffer solutions	– Select the suitable buffer solutions for the calibration procedure
	– Buffer solutions too old	– Use only once. Note the shelf life
No stable measured value	Cause	Remedy
	<i>pH electrode:</i>	
	– Junction contaminated	– Clean the junction
	– Membrane contaminated	– Clean the membrane
<i>Test sample:</i>		
	– pH value not stable	– Measure with air excluded if necessary
	– Temperature not stable	– Temper if necessary
<i>Electrode + test sample:</i>		
	– Conductivity too low (e.g. in ultrapure water)	– Use suitable electrode
	– Temperature too high	– Use suitable electrode
	– Organic liquids	– Use suitable electrode

Obviously incorrect measured values

Cause	Remedy
<i>pH electrode:</i>	
– not connected	– Connect electrode
– Cable broken	– Exchange the cable or electrode
– pH electrode unsuitable	– Use suitable electrode
– Temperature difference between buffer and test sample too great	– Adjust temperature of buffer or sample solutions
– Measurement procedure not suitable	– Follow special procedure

Sensor symbol flashes

Cause	Remedy
– Calibration interval expired	– Recalibrate the measuring system

7 Technical data

7.1 General data

Dimensions	Approx. 236 x 86 x 117 mm	
Weight	Approx. 0.6 kg (without batteries)	
Mechanical structure	Type of protection	IP 67
Electrical safety	Protective class	III
Test certificates	CE, FCC	
Ambient conditions	Storage	- 25 °C ... + 65 °C
	Operation	0 °C ... + 50 °C
	Climatic class	2
Allowable relative humidity	Yearly mean:	75 %
	30 days /year:	95 %
	Other days:	85 %
Power supply	Batteries	4 x 1.5 V, type AA
	Operating time with battery operation	approx. 5000 measurements
	Battery pack (optional)	5 x 1.2 V nickel metal hydride (NiMH), type AA
	Power pack/ charging device (optional)	FRIWO FW7555M/09, 15.1432.500-00 Friwo Part. No. 1883259 ----- RiHuiDa RHD20W090150 ----- Input: 100 ... 240 V ~ / 50 ... 60 Hz / 400 mA Output: 9 V = / 1.5 A Connection max. overvoltage category II Primary plugs contained in the scope of delivery: Euro, US, UK and Australian.

Serial interface	Connection of the cable AK 540/B or AK 540/S	
	Baud rate	Adjustable: 1200, 2400, 4800, 9600, 19200 baud
	Type	RS232
	Data bits	8
	Stop bits	2
	Parity	None
	Handshake	RTS/CTS
	Cable length	Max. 15 m
Guidelines and norms used	EMC	EC guideline 89/336/EEC EN 61326-1/A3:2003 FCC Class A
	Meter safety	EEC guideline 73/23/EEC EN 61010-1 :2001
	Climatic class	VDI/VDE 3540
	IP protection class	EN 60529:1991

7.2 Photometry

Optical measuring principle	LED photometer with filter	
Interference filter	436 nm, 517 nm, 557 nm, 594 nm, 610 nm, 690 nm	
Photometric reproducibility	Accuracy:	± 2 nm
Photometric resolution	0.005 or better	
Warm-up time	None	
Measuring time	Approx. 2s	
Measured parameters	Concentration (method dependent, selectable display type), absorbance, transmission	
Measuring range	Absorbance:	-2.000 ... +2.000
	Transmission:	1 ... 150 %
User-defined programs	100	
Resolution Transmission	1.00 ... 9.99	0.01 %
	10.0 ... 150	0.1 %

7.3 pH value / ORP voltage

Measuring ranges, resolution	Variable	Measuring range	Resolution
	pH	- 2.00 ... + 16.00	0.01
	U [mV]	- 1000 ... + 1000	1
	T [°C]	- 5.0 ... + 100.0	0.1
	T [°F]	- 23.0 ... + 212.0	0.1

Manual temperature input	Variable	Range	Increment
	T _{manual} [°C]	- 20 ... + 100	1

Accuracy (± 1 digit)	Variable	Accuracy	Temperature of the test sample
	pH *	± 0.01	+ 15 °C ... + 35 °C
	U [mV]	± 1	+ 15 °C ... + 35 °C
	T [°C]	± 0.3	0 °C ... + 55 °C
	T [°F]	± 0.54	0 °C ... + 55 °C

* when measuring in a range of ± 2 pH around a calibration point

8 Accessories and options

8.1 Accessories

Description	Model	Order no.
LabStation with PC software LSdata, battery pack and universal power pack	LS Flex/430	251 301
Batteries for pHotoFlex	RB Flex/430	251 300
3 replacement cells, 28 x 60 mm	LKS28-Set	251 302
Calibration set for Turb 430 IR/photoFlex Turb	Kal.Kit Turb 430 IR	600 560
Thermoprinter*	P3001	250 045
Matrix printer*	LQ 300+	250 046
16 mm cells	RK 14/25	250 621

* A connection cable is required to connect the printer (see section 8.1.1)

8.1.1 Connecting cable

PC You can connect a PC to the pHotoFlex® pH in one of the following ways:

Description	Model	Order no.
● Connection PC - pHotoFlex® pH		
– Cable	AK 540/B	902 842
+ USB adapter (for USB connection on PC)	Ada USB	902 881
● Connection PC - LabStation		
– Zero modem cable	included in the scope of delivery of the LabStation	
+ USB adapter (for USB connection on PC)	Ada USB	902 881

Thermoprinter

You can connect the P3001 to the pHotoFlex® pH in the following ways:

Description	Model	Order no.
● Connection P3001 - pHotoFlex® pH		
– Cable	AK 540/S	902 843
● Connection P3001 - LabStation		
– Cable in conjunction with an adapter (socket - socket) [GenderChanger]	AK 3000 Specialist shops	250 745
or:		
– Cable, 2 x 9-pin (socket - plug)	Specialist shops	

Matrix printer

You can connect an LQ300 needle printer to the pHotoFlex® pH in one of the following ways:

Description	Model	Order no.
● Connection LQ300 - pHotoFlex® pH		
– Cable with adapter 9-pin (plug) - 25-pin (plug)	AK 540/B Specialist shops	902 842
● Connection LQ300 - LabStation		
– Cable in conjunction with an adapter (socket - socket) [GenderChanger]	AK/LQ300 Specialist shops	250 746
or:		
– Zero modem cable, 9-pin (socket) - 25-pin (plug)	Specialist shops	

8.2 Optional extensions of the pHotoFlex® pH

The following optional extensions are available in specialist shops:

Device/cable	Model
Bar code reader*	<ul style="list-style-type: none">● Handscanner Datalogic DLC6065-M1● Handscanner Datalogic Touch65
Connection cable Bar code reader - LabStation	Datalogic CAB-350

* In addition to the bar code reader, a suitable connection cable is required to operate the bar code reader

9 Firmware update

General information

With the aid of a PC, you can update the firmware of the pHotoFlex® pH to the latest version.

You can find available firmware update files for your meter on the Internet.

The update program contains:

- the newest firmware (meter software)
- new or changed method data and programs.

Connecting the meter to the PC

The following is required for connection to a PC:

- a free serial interface (COM or USB port) on your PC
- cable or LabStation with cable for connection to PC
 - for direct connection of the meter to the PC:
the AK 540/B interface cable (accessory) or
 - for connection with the LabStation:
an operable LabStation with null modem cable (accessory, see section 8.1)
- for connection to a USB interface on the PC:
a USB adapter (accessory).



Prior to starting the update please make sure that the batteries are fully loaded, or operate the pHotoFlex® pH on the LabStation or with the power pack. Otherwise there is the risk of the pHotoFlex® pH crashing during the update.

Program installation Program start

Install the firmware update program on your PC.

Start the program from the Windows start menu.

Via the language menu you can change the adjusted language.

Under Microsoft Windows 7, administrator rights are required.

Firmware update

Proceed as follows:

- 1 Connect the pHotoFlex® pH to an interface (COM port) of the PC .
- 2 Make sure the pHotoFlex® pH is switched on.
- 3 To start the updating process click the OK button.
- 4 Then follow the instructions of the program.

The programming process takes approx. 5 minutes. A terminatory message is displayed after a successful programming process. The firmware update is now completed.

- 5 Disconnect the meter from the PC.
The meter is ready for operation.

After switching the meter off and on you can check whether the meter has taken over the new software version on the start display.

10 Disposal

Handle and dispose of all waste in compliance with local laws and regulations.

EU only: Correct disposal of this product — WEEE Directive on waste electrical and electronic equipment

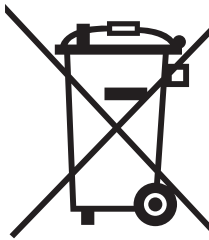

This marking on the product, accessories or literature indicates that the product should not be disposed of with other waste at the end of its working life.

To prevent possible harm to the environment or human health from uncontrolled waste disposal, please separate these items from other types of waste and recycle them responsibly to promote the sustainable reuse of material resources.



Waste from electrical and electronic equipment can be returned to the producer or distributor.

EU only: Correct disposal of batteries in this product

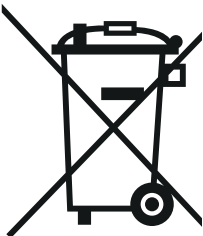

This marking on the battery, manual or packaging indicates that the batteries in this product should not be disposed of with other waste at the end of its working life. Where marked, the chemical symbols Hg, Cd or Pb indicate that the battery contains mercury, cadmium or lead above the reference levels in Directive 2006/66/EC. If batteries are not properly disposed of, these substances can cause harm to human health or the environment.

To protect natural resources and to promote material re-use, please separate batteries from other types of waste and recycle them through your local, free battery return system.

11 Lists

This chapter provides additional information and orientation aids.

Abbreviations

The list of abbreviations explains the indicators and the abbreviations that appear on the display and in the manual.

Specialist terms

The glossary briefly explains the meaning of the specialist terms. However, terms that should already be familiar to the target group are not described here.

Abbreviations

°C	Temperature unit, degrees Celsius
°F	Temperature unit, degrees Fahrenheit
Asy	Asymmetry
Cal	Calibration
d	Day
h	Hour
j	Year
K	Temperature unit, Kelvin
LoBat	Batteries almost empty (Low battery)
m	Month
mV	Voltage unit
mV/pH	Unit of the electrode slope (internat. mV)
<i>NIST/DIN</i>	Automatic calibration for pH measurements with buffer solutions, produced according to NIST or DIN 19 266
pH	pH value
s	Second
S	Slope (internat. k)
SELV	Safety Extra Low Voltage
<i>Slp.</i>	Slope determined with calibration
<i>TEC</i>	Automatic calibration for für pH measurements with WTW Technical buffer solutions according to DIN 19267
U	Voltage

Glossary

Adjusting	To manipulate a measuring system so that the relevant value (e.g. the displayed value) differs as little as possible from the correct value or a value that is regarded as correct, or that the difference remains within the tolerance.
Analysis specification	The exact proceeding to carry out the detection procedure is described in the analysis instructions.
Asymmetry	Designation of the offset potential of a pH electrode. It is the measurable potential of a symmetrical electrode, the membrane of which is immersed in a solution with the pH of the nominal electrode zero point (WTW electrode pH = 7).
AutoRange	Name of the automatic selection of the measuring range.
AutoRead	WTW name for a function to check the stability of the measured value.
Blank value (reagent blank value)	The evaluation of the photometric measurement always refers to the comparison value of a sample without the substance to be determined (reagent blank value). Thus the influence of the basic absorbance of the reagents on photometric measurement is compensated for.
Calibration	Comparing the value from a measuring system (e. g. the displayed value) to the correct value or a value that is regarded as correct. Often, this expression is also used when the measuring system is adjusted at the same time (see adjusting).
Cell	Vessel that takes a liquid sample for the photometric measurement. The cell material (mostly glass) must have certain optical features to be suitable for photometry.
Citation forms	Different forms of representing a measured concentration value that can be derived from each other. The method for determining phosphate provides, for example, a measured value for phosphorous P. This measured value can also be quoted in other citation forms such as PO ₄ , PO ₄ -P or P ₂ O ₅ .
Detection procedure	The detection procedure designates the general principle of how a sample is brought into a form suitable for measurement. Different methods can be based on the same detection procedure.
Electrode zero point	The zero point of a pH combination electrode is the pH value at which the electromotive force of the pH combination electrode at a specified temperature is zero. Normally, this is at 25 °C.
Electromotive force of an electrode	The electromotive force U of the combination electrode is the measurable electromotive force of an electrode in a solution. It equals the sum of all the galvanic voltages of the combination electrode. Its dependency on the pH results in the electrode function, which is characterized by the parameters, slope and zero point.

Junction	The junction is a porous body in the housing wall of reference electrodes or electrolyte bridges. It arranges the electrical contact between two solutions and makes the electrolyte exchange more difficult. The expression, junction, is also used for ground or junction-less transitions.
LED	Light Emitting Diode LEDs are used as the light source in the pHotoFlex® pH.
Measured parameter	The measured parameter is the physical dimension determined by measuring, e.g. pH, conductivity or D.O. concentration.
Measured value	The measured value is the special value of a measured parameter to be determined. It is given as a combination of the numerical value and unit (e. g. 3 m; 0.5 s; 5.2 A; 373.15 K).
Measuring system	The measuring system comprises all the devices used for measuring, e. g. measuring instrument and sensor. In addition, there is the cable and possibly an amplifier, terminal box and armature.
Method	A method comprises a chemical detection procedure and special method data (calibration line) that are required to evaluate the measurement results. How to carry out the method up to the photometric measuring is described in the analysis instructions. The pHotoFlex® pH contains a database with methods (programs). Furthermore, user-defined methods can be entered in the database as well.
Molality	Molality is the quantity (in Mol) of a dissolved substance in 1000 g solvent.
MultiCal®	WTW name stating that a meter provides several pH calibration procedures.
Offset potential	The measurable potential of a symmetrical electrode, the membrane of which is immersed in a solution with the pH of the nominal electrode zero point. The asymmetry is part of the offset potential .
ORP	The ORP is caused by oxidizing or reducing substances dissolved in water if these substances become effective on an electrode surface (e.g. a gold or platinum surface).
pH value	The pH value is a measure of the acidic or basic effect of an aqueous solution. It corresponds to the negative decadic logarithm of the molal hydrogen ions activity divided by the unit of the molality. The practical pH value is the value of a pH measurement.
Potentiometry	Name of a measuring technique. The signal (depending on the measured parameter) of the electrode is the electrical potential. The electrical current remains constant.

Program	In the pHotoFlex® pH, methods with the relevant method data are stored as programs. Programs are called up via the assigned program number.
Reset	Restoring the original condition of all settings of a measuring system.
Resolution	Smallest difference between two measured values that can be displayed by a meter.
Slope	The slope of a linear calibration function.
Standard solution	The standard solution is a solution where the measured value is known by definition. It is used to calibrate a measuring system.
Temperature function	Name of a mathematical function expressing the temperature behavior of a test sample, a sensor or part of a sensor.
Test sample	Designation of the test sample ready to be measured. Normally, a test sample is made by processing the original sample. The test sample and original sample are identical if the test sample was not processed.
Test set (test)	A test set contains all reagents that are required for the photometric determination of the sample according to the analysis instructions.
Zero adjustment	Adjusting a photometer with a water-filled cell. The zero adjustment applies to measuring all measured parameters (concentration, absorbance, transmission) of a photometer.

12 Index

A

Absorbance / % Transmission, measuring ..	40
Analysis specification	31
Analysis timer	43
Asymmetry of the pH electrode	49
Automatic switch-off function	14, 17
AutoRead	
ORP	48
pH	47

B

Blank value	36
Blank value measurement	36

C

Calibration	
pH	49
Calibration evaluation	
pH	51
Calibration points	
pH	50
Cleaning	74
Concentration measurement	33
Connecting sensors	9
Connectors	9

D

Data filter	58
Data memory	29
Dataset	56
Date and time	24
Date/time	31
Default settings	
Measured parameter	67
System settings	66
Display	9, 30
Display illumination	9, 18
Drift control	
ORP	48
pH	47

F

Filter	58
Firmware update	86

I

Initial commissioning	16
Initialize	66
Inserting a cell	18
Interface	30

K

Key functions	7
Keys	7

M

Measure diluted sample	44
Measured value display	21
Measurement data memory	
Storage locations	56
Measurement dataset	56
Measuring	
ORP	47
pH	47
Measuring menu	
pH/ORP	29, 48
Menus (navigation)	21
Messages	22
Method	31

N

Navigation	21
------------------	----

O

Operating modes	20
-----------------------	----

P

pH buffer sets	49
Photometric determination	31
Power pack	13
Program	31
Programs	43

R

Rechargeable battery	
Charging time	13
Reset	66
RS232 socket assignment	62

S

Safety	11
Scope of delivery	13
Single-point calibration	
pH	54
Slope	
pH	49
Storing in memory	56
Switching on	17
System menu	
General information	30, 33
System settings	28
General information	28, 31

T

Temperature measurement	
pH	46
Test set	31
Three-point calibration	
pH	55
Timer	44
Transmitting data	60
Transmitting measured values	60
Two-point calibration	
pH	54

U

User-defined programs	43
-----------------------------	----

Z

Zero adjustment	41
-----------------------	----

Xylem |'zīləm|

- 1) The tissue in plants that brings water upward from the roots;
- 2) a leading global water technology company.

We're a global team unified in a common purpose: creating advanced technology solutions to the world's water challenges. Developing new technologies that will improve the way water is used, conserved, and re-used in the future is central to our work. Our products and services move, treat, analyze, monitor and return water to the environment, in public utility, industrial, residential and commercial building services settings. Xylem also provides a leading portfolio of smart metering, network technologies and advanced analytics solutions for water, electric and gas utilities. In more than 150 countries, we have strong, long-standing relationships with customers who know us for our powerful combination of leading product brands and applications expertise with a strong focus on developing comprehensive, sustainable solutions.

For more information on how Xylem can help you, go to www.xylem.com.



Service and Returns:

Xylem Analytics Germany
Sales GmbH & Co. KG
WTW
Am Achalaich 11
82362 Weilheim
Germany

Tel.: +49 881 183-325
Fax: +49 881 183-414
E-Mail wtw.rma@xylem.com
Internet: www.xylemanalytics.com



Xylem Analytics Germany GmbH
Am Achalaich 11
82362 Weilheim
Germany

