

OPERATING MANUAL

ba77053d04 08/2021

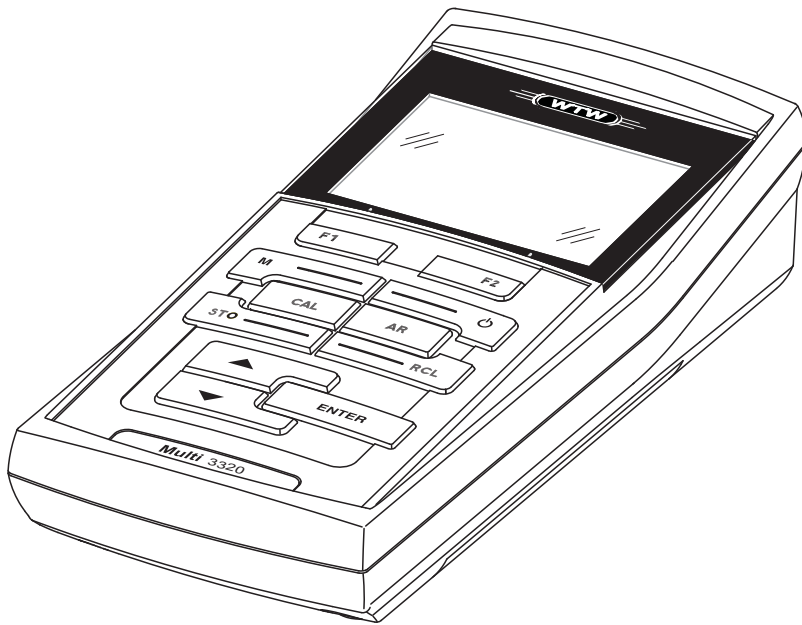

Multi 3320

METER FOR 2 SENSORS (PH/ORP/D.O./COND)



a xylem brand



For the most recent version of the manual, please visit www.WTW.com.

Copyright

© 2021 Xylem Analytics Germany GmbH
Printed in Germany..

Multi 3320 - Contents

1	Overview	7
1.1	Multi 3320 meter	7
1.2	Sensors	7
2	Safety	9
2.1	Safety information	9
2.1.1	Safety information in the operating manual	9
2.1.2	Safety signs on the meter	9
2.1.3	Further documents providing safety information	9
2.2	Safe operation	10
2.2.1	Authorized use	10
2.2.2	Requirements for safe operation	10
2.2.3	Unauthorized use	10
3	Commissioning	11
3.1	Scope of delivery	11
3.2	Power supply	11
3.3	Initial commissioning	11
3.3.1	Inserting the batteries	12
4	Operation	13
4.1	General operating principles	13
4.1.1	Keypad	13
4.1.2	Display	14
4.1.3	Status information (meter)	14
4.1.4	Connectors	15
4.2	Switching on the meter	15
4.3	Switching off	16
4.4	Navigation	16
4.4.1	Operating modes	16
4.4.2	Measured value display	17
4.4.3	Menus and dialogs	17
4.4.4	Elements in menus and dialogs	17
4.4.5	Navigation example 1: Setting the language	18
4.4.6	Example 2 on navigation: Setting the date and time	20
4.5	Channel display	22
4.5.1	Display of several sensors in the measuring mode	22

5	pH value	23
5.1	Measuring	23
5.1.1	Measuring the pH value	23
5.1.2	Measuring the temperature	24
5.2	Calibration	25
5.2.1	Why calibrate?	25
5.2.2	When do you have to calibrate?	25
5.2.3	Automatic calibration (AutoCal)	25
5.2.4	Manual calibration (ConCal)	28
5.2.5	Calibration points	31
5.2.6	Calibration data	32
5.2.7	Continuous measurement control (CMC function)	35
6	ORP voltage	36
6.1	Measuring	36
6.1.1	Measuring the ORP	36
6.1.2	Measuring the temperature	37
6.2	ORP calibration	37
7	Ion concentration	38
7.1	Measuring	38
7.1.1	Measuring the ion concentration	38
7.1.2	Measuring the temperature	39
7.2	Calibration	40
7.2.1	Why calibrate?	40
7.2.2	When to calibrate?	40
7.2.3	Calibration (ISE Cal)	40
7.2.4	Calibration standards	43
7.2.5	Calibration data	43
8	Dissolved oxygen	45
8.1	Measuring	45
8.1.1	Measuring D.O.	45
8.1.2	Measuring the temperature	46
8.2	Calibration	47
8.2.1	Why calibrate?	47
8.2.2	When to calibrate?	47
8.2.3	Calibration procedure	47
8.2.4	Calibration in water vapor-saturated air (air calibration vessel)	47
8.2.5	Calibrating with a comparison measurement (OxiComp)	48
8.2.6	Calibration data	50
9	Conductivity	52

9.1	Measuring	52
9.1.1	Measuring the conductivity.	52
9.1.2	Measuring the temperature	53
9.2	Calibration	54
9.2.1	Why calibrate?	54
9.2.2	When to calibrate?	54
9.2.3	Determining the cell constant (calibration in control standard)	54
9.2.4	Calibration data	55
10	Settings	57
10.1	Measurement settings	57
10.1.1	Settings for pH measurements.	57
10.1.2	Buffer sets for calibration	58
10.1.3	Calibration interval	61
10.1.4	Settings for ORP measurements	61
10.1.5	Settings for ISE measurements	62
10.1.6	Settings for D.O. sensors	64
10.1.7	Calibration interval	65
10.1.8	Settings for conductivity measuring cells	66
10.1.9	Calibration interval	68
10.1.10	Temperature compensation	68
10.1.11	Setting the TDS factor	69
10.2	Sensor-independent settings	70
10.2.1	<i>System</i>	70
10.2.2	<i>Data storage</i>	71
10.2.3	<i>Automatic Stability control</i>	71
10.3	Reset.	72
10.3.1	Resetting the measurement settings.	72
10.3.2	Resetting the system settings	74
11	Data memory	75
11.1	Manual storage	75
11.2	Automatic data storage at intervals	76
11.3	Measurement data memory	78
11.3.1	Editing the measurement data memory	78
11.3.2	Erasing the measurement data memory	80
11.3.3	Measurement dataset	80
11.3.4	Memory locations	80
12	Transmitting data (USB interface).	81
12.1	Options for data transmission	81
12.2	Connecting a PC	82
12.3	MultiLab Importer	82
13	Maintenance, cleaning, disposal.	83

- 13.1 Maintenance 83
 - 13.1.1 General maintenance activities..... 83
 - 13.1.2 Replacing the batteries..... 83
- 13.2 Cleaning..... 84
- 13.3 Packing 84
- 13.4 Disposal..... 84
 - 13.4.1 85
 - 13.4.2 85
- 14 What to do if... 86**
 - 14.1 pH/ORP 86
 - 14.2 ISE..... 88
 - 14.3 Dissolved oxygen..... 89
 - 14.4 Conductivity..... 90
 - 14.5 General information..... 91
- 15 Technical data 92**
 - 15.1 Measuring ranges, resolution, accuracy 92
 - 15.1.1 pH/ORP 92
 - 15.1.2 ISE 93
 - 15.1.3 Oxi 93
 - 15.1.4 Cond..... 95
 - 15.2 General data 96
- 16 Firmware update 98**
- 17 Glossary..... 99**
- 18 Index..... 103**

1 Overview

1.1 Multi 3320 meter

The Multi 3320 meter enables you to perform measurements (pH, U, ISE, conductivity, dissolved oxygen) quickly and reliably.

The Multi 3320 provides the maximum degree of operating comfort, reliability and measuring certainty for all applications.

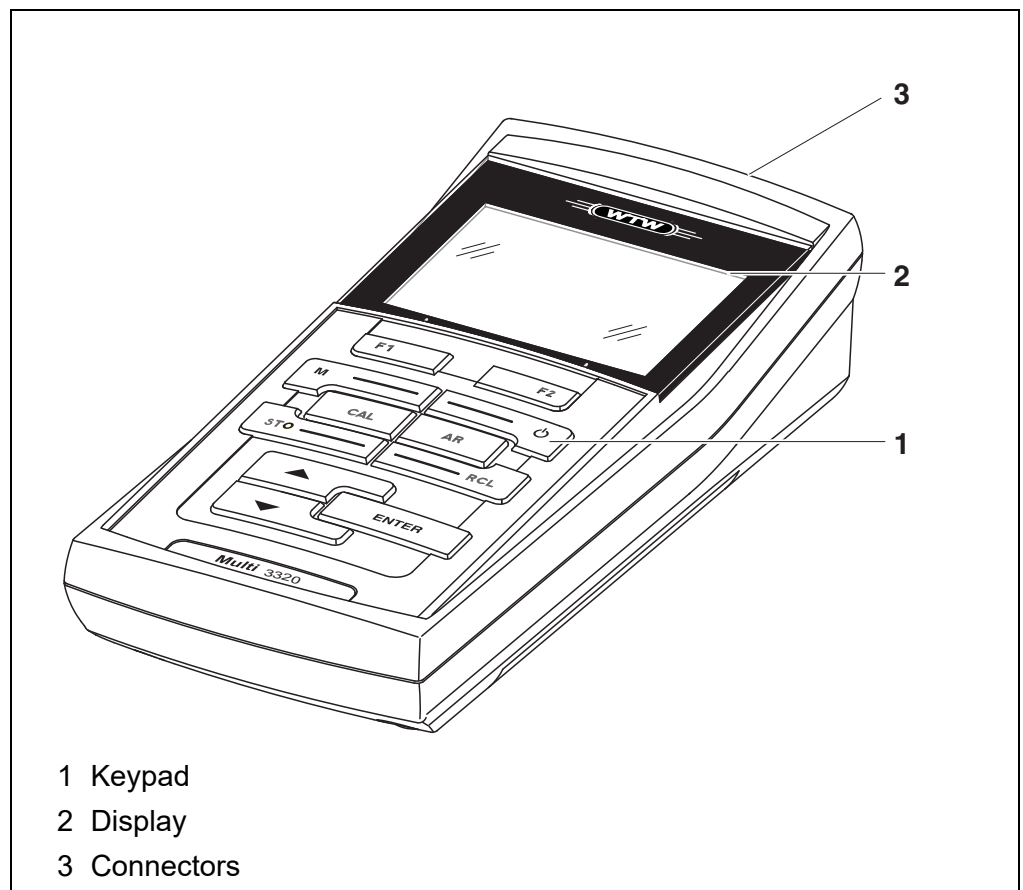

1.2 Sensors

A measuring system ready to measure consists of the Multi 3320 meter and a suitable sensor.

Suitable sensors are pH electrodes, ion selective electrodes (ISE), ORP electrodes, dissolved oxygen (D.O.) sensors and conductivity measuring cells.

Suitable sensors are pH electrodes, ion selective electrodes (ISE) and ORP electrodes.



Information on available sensors is given on the Internet and in the WTW catalog, "Laboratory and field instrumentation".

2 Safety

2.1 Safety information

2.1.1 Safety information in the operating manual

This operating manual provides important information on the safe operation of the meter. Read this operating manual thoroughly and make yourself familiar with the meter before putting it into operation or working with it. The operating manual must be kept in the vicinity of the meter so you can always find the information you need.

Important safety instructions are highlighted in this operating manual. They are indicated by the warning symbol (triangle) in the left column. The signal word (e.g. "CAUTION") indicates the level of danger:

**WARNING**

indicates a possibly dangerous situation that can lead to serious (irreversible) injury or death if the safety instruction is not followed.

**CAUTION**

indicates a possibly dangerous situation that can lead to slight (reversible) injury if the safety instruction is not followed.

NOTE

indicates a possibly dangerous situation where goods might be damaged if the actions mentioned are not taken.

2.1.2 Safety signs on the meter

Note all labels, information signs and safety symbols on the meter and in the battery compartment. A warning symbol (triangle) without text refers to safety information in this operating manual.

2.1.3 Further documents providing safety information

The following documents provide additional information, which you should observe for your safety when working with the measuring system:

- Operating manuals of sensors and other accessories
- Safety datasheets of calibration or maintenance accessories (such as buffer solutions, electrolyte solutions, etc.)

2.2 Safe operation

2.2.1 Authorized use

This meter is authorized exclusively for pH, ISE, ORP, dissolved oxygen and conductivity measurements in a field and laboratory environment.

This meter is authorized exclusively for pH, ISE and ORP measurements in a field and laboratory environment.

Only the operation and running of the meter according to the instructions and technical specifications given in this operating manual is authorized (see section 15 TECHNICAL DATA, page 92).

Any other use is considered unauthorized.

2.2.2 Requirements for safe operation

Note the following points for safe operation:

- The meter may only be operated according to the authorized use specified above.
- The meter may only be supplied with power by the energy sources mentioned in this operating manual.
- The meter may only be operated under the environmental conditions mentioned in this operating manual.
- The meter may only be opened if this is explicitly described in this operating manual (example: Inserting the batteries).

2.2.3 Unauthorized use

The meter must not be put into operation if:

- it is visibly damaged (e.g. after being transported)
- it was stored under adverse conditions for a lengthy period of time (storing conditions, see section 15 TECHNICAL DATA, page 92).

3 Commissioning

3.1 Scope of delivery

- MeterMulti 3320
- 4 batteries 1.5 V Mignon type AA
- Short instructions
- CD-ROM with
 - USB drivers
 - detailed operating manual
 - Software MultiLab Importer

3.2 Power supply

The Multi 3320 is supplied with power in the following ways:

- Battery operation (4 x alkaline manganese batteries, type AA)
- USB operation via a connected USB-B cable

3.3 Initial commissioning

Perform the following activities:

- Insert the supplied batteries
- Switch on the meter
(see section 4.2 SWITCHING ON THE METER, page 15)
- Set the date and time
(see section 4.4.6 EXAMPLE 2 ON NAVIGATION: SETTING THE DATE AND TIME, page 20)

3.3.1 Inserting the batteries

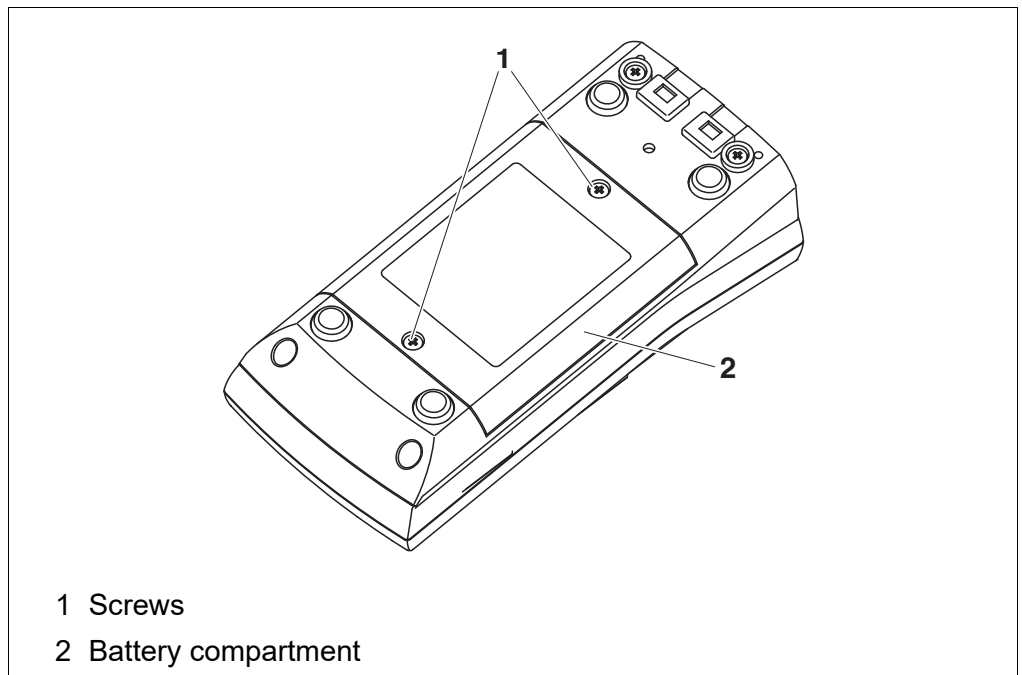
**CAUTION**

Make sure that the poles of the batteries are positioned correctly. The \pm signs on the batteries must correspond to the \pm signs in the battery compartment.



You can operate the meter either with normal batteries or with rechargeable batteries (Ni-MH). In order to charge the batteries, an external charging device is required.

1. Place four batteries (type Mignon AA) in the battery compartment.
2. Close the battery compartment.
3. Set the date and time
(see section 4.4.6 EXAMPLE 2 ON NAVIGATION: SETTING THE DATE AND TIME, page 20).











4 Operation

4.1 General operating principles

4.1.1 Keypad

In this operating manual, keys are indicated by brackets <.> .



The key symbol (e.g. **<ENTER>**) generally indicates a short keystroke (under 2 sec) in this operating manual. A long keystroke (approx. 2 sec) is indicated by the underscore behind the key symbol (e.g. **<ENTER__ >**).

	<F1> : <F1__> :	Softkeys providing situation dependent functions, e.g.: <F2> /[USB output]: Outputs data to the USB interface <F2__> /[USB output]: Configures the automatic data output to the USB interface
	<F2> : <F2__> :	
	<On/Off> :	Switches the meter on or off
	<M> :	Selects the measured parameter / Quits the settings
	<CAL> : <CAL__> :	Calls up the calibration procedure Displays the calibration data
	<STO> : <STO__ > :	Saves a measured value manually Opens the menu for the automatic save function
	<RCL> : <RCL__> :	Displays the manually stored measured values Displays the automatically stored measured values
 	<▲><▼> : <▲__><▼__> : <__> :	Menu control, navigation Increments, decrements values Increments, decrements values continuously
	<ENTER> : <ENTER__> : > :	Opens the menu for measurement settings / confirms entries Opens the menu for system settings
	<AR>	Freezes the measured value (HOLD function) Switches the AutoRead measurement on or off

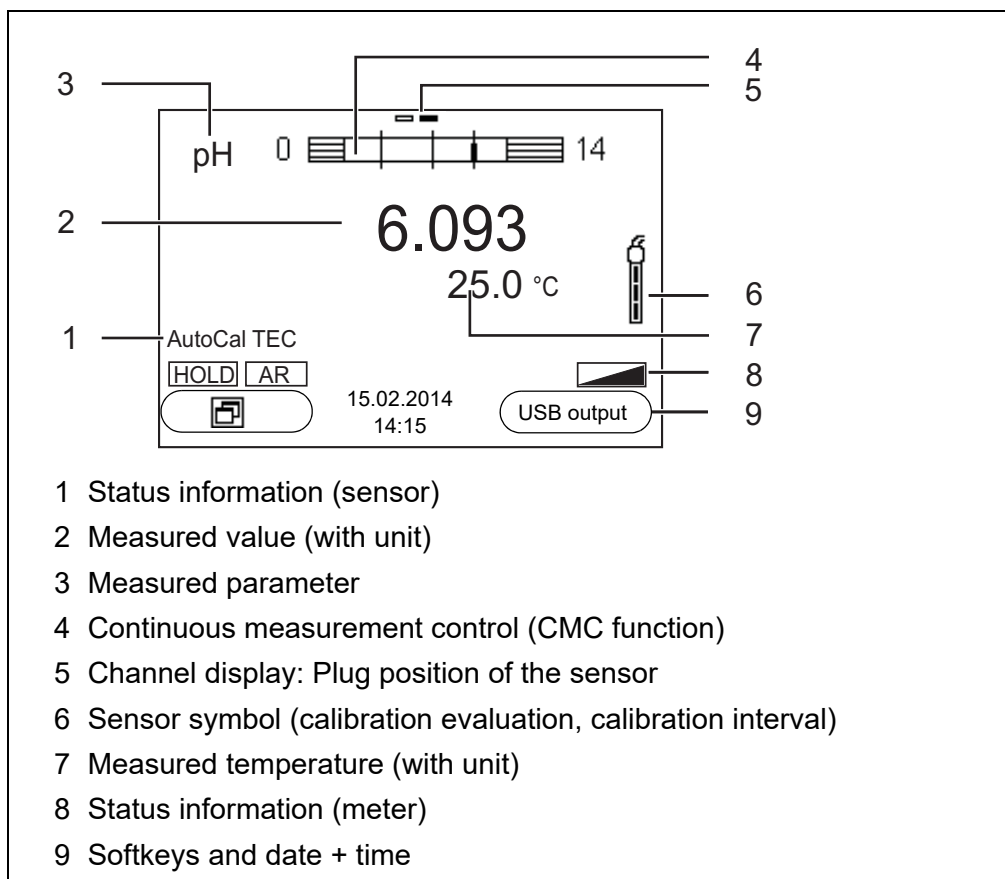
4.1.2 Display



4.1.3 Status information (meter)

AR	Stability control (AutoRead) is active
HOLD	Measured value is frozen (<AR> key)
	Batteries are almost empty
	Data are automatically output to the USB-B interface at intervals

4.1.4 Connectors

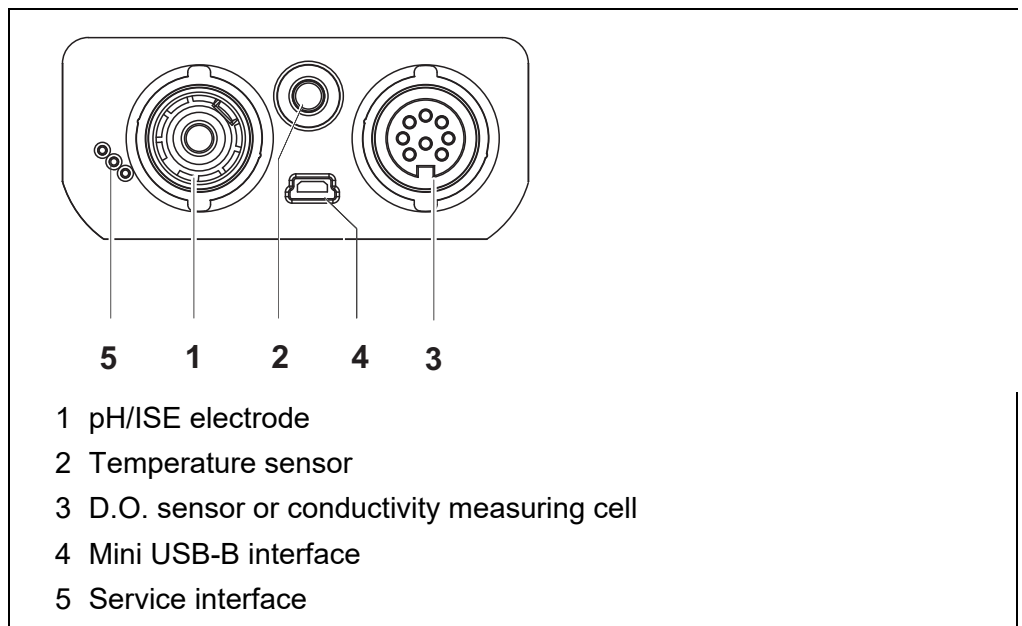

CAUTION

Only connect sensors to the meter that cannot return any voltages or currents that are not allowed (> SELV and > current circuit with current limiting).

Almost all customary sensors fulfill these conditions.

4.2 Switching on the meter

1. Switch the meter on with **<On/Off>**.
The meter performs a self-test.
The display shows the manufacturer's logo while the self-test is being performed.
The measured value display appears.

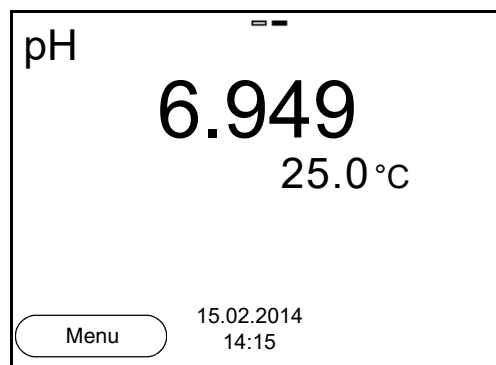

4.3 Switching off

1. Switch the printer off with **<On/Off>**.

Automatic shut-off function

The instrument has an automatic shut-off function in order to save the batteries (see section 10.2.1 SYSTEM, page 70). The automatic shut-off function switches off the meter if no key is pressed for an adjustable period.

The automatic shut-off function is not active

- if the communication cable is connected
- if the *Automatic data storage* function is active, or with automatic data transmission

Display illumination

The meter automatically switches off the display illumination if no key is pressed for 30 seconds. The illumination is switched on with the next keystroke again.

You can also generally switch the display illumination on or off (see section 10.2.1 SYSTEM, page 70).

4.4 Navigation

The principles of navigation in menus and dialogs are explained in the following sections.

4.4.1 Operating modes

The instrument has the following operating modes:

Operating mode	Explanation
Measuring	The measurement data of the connected sensor are shown in the measured value display
Calibration	The course of a calibration with calibration information, functions and settings is displayed
Storing in memory	The meter stores measuring data automatically or manually
Transmitting data	The meter transmits measuring data and calibration records to a USB-B interface automatically or manually.
Setting	The system menu or a sensor menu with submenus, settings and functions is displayed

Only those displays and functions are available in the active operating mode that are currently being required.

4.4.2 Measured value display

In the measured value display, open the setting menus with **<ENTER>**. The current functions of the softkeys are shown on the display.

- Use **<ENTER>** (short pressure) to open the menu for calibration and measurement settings for the displayed measured parameter.
- Use **<ENTER__ >** (long keystroke (approx. 2 s) to open the *Storage & config* menu with the sensor-independent settings.

Use the keys of the keypad to carry out further functions such as storage or calibration (see section 4.1.1 KEYPAD, page 13). These functions are not available in other operating situations.

4.4.3 Menus and dialogs

The menus for settings and dialogs in procedures contain further subelements.

- To select a subelement, use the **<▲><▼>** keys. The current selection is displayed with a frame.
- To make further settings, switch to the next higher menu level with **<F1>**[Back].
- Use **<M>** to return to the measured value display.

4.4.4 Elements in menus and dialogs

- Submenus

The name of the submenu is displayed at the upper edge of the frame. Submenus are opened by confirming with **<ENTER>**. Example:

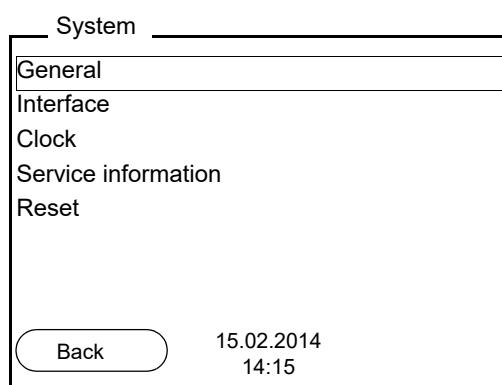

- Settings

Settings are indicated by a colon. The current setting is displayed on the right-hand side. The setting mode is opened with **<ENTER>**. Subsequently, the setting can be changed with **<▲><▼>** and **<ENTER>**. Example:

General	
Language:	Deutsch
Beep:	Off
Illumination:	On
Contrast:	50 %
Switchoff time:	1 h
Temperature unit:	°C
Stability control:	On
<input type="button" value="Back"/> 15.02.2014 14:15	

- **Functions**

Functions are designated by the name of the function. They are immediately carried out by confirming with **<ENTER>**.

Example: Display the *Calibration record* function.

pH	
Calibration record	
Calibration data storage	
Buffer:	TEC
One point calibration:	Yes
Calibration interval:	7 d
Unit for slope:	mV/pH
i 2.00 4.01 7.00 10.01 (25 °C)	
<input type="button" value="Back"/> 15.02.2014 14:15	

- **Messages**

Information is marked by the **i** symbol. It cannot be selected. Example:

pH	
Calibration record	
Calibration data storage	
Buffer:	<input type="text" value="TEC"/>
One point calibration:	Yes
Calibration interval:	7 d
Unit for slope:	mV/pH
i 2.00 4.01 7.00 10.01 (25 °C)	
<input type="button" value="Back"/> 15.02.2014 14:15	

4.4.5 Navigation example 1: Setting the language

1. Press the **<On/Off>** key.
The measured value display appears.
The instrument is in the measuring mode.

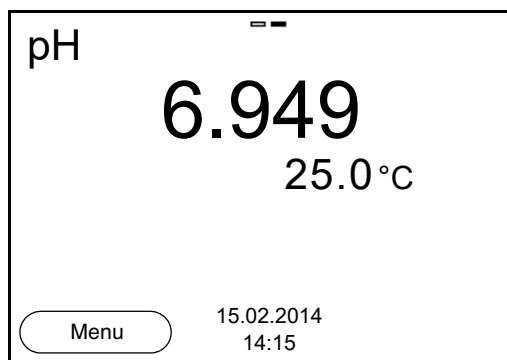

2. Open the *Storage & config* menu with **<ENTER>**. The instrument is in the setting mode.

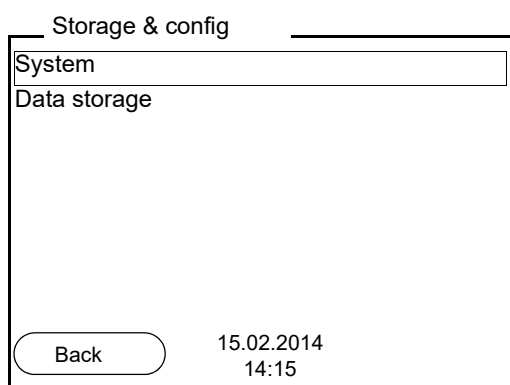

3. Select the *System* submenu with **<▲><▼>**. The current selection is displayed with a frame.
4. Open the *System* submenu with **<ENTER>**.

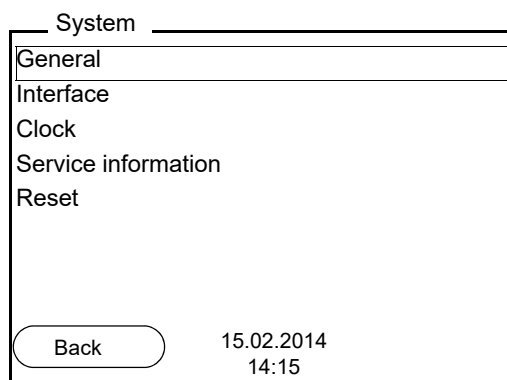

5. Select the *General* submenu with **<▲><▼>**. The current selection is displayed with a frame.
6. Open the *General* submenu with **<ENTER>**.

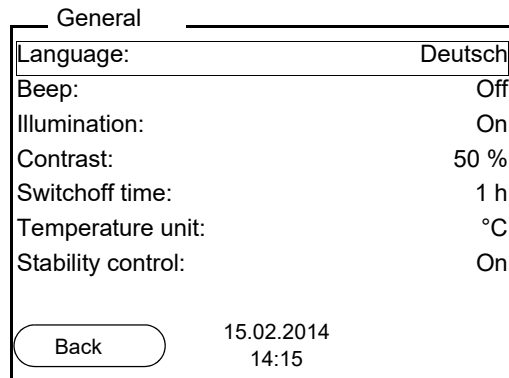

7. Open the setting mode for the *Language* with **<ENTER>**.

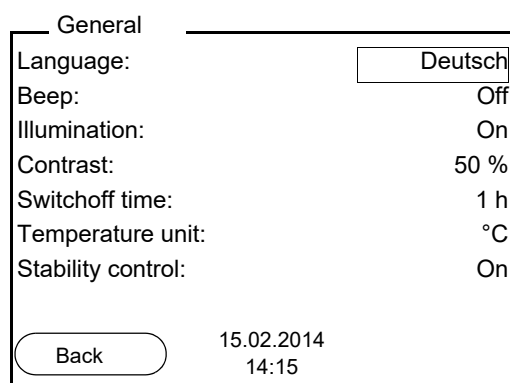

8. Select the required language with **<▲><▼>**.
9. Confirm the setting with **<ENTER>**.
The meter switches to the measuring mode.
The selected language is active.

4.4.6 Example 2 on navigation: Setting the date and time

The meter has a clock with a date function. The date and time are shown in the measured value display.

When storing measured values and calibrating, the current date and time are automatically stored as well.

The correct setting of the date and time and date format is important for the following functions and displays:

- Current date and time
- Calibration date
- Identification of stored measured values.

Therefore, check the time at regular intervals.



After a fall of the supply voltage (empty batteries), the date and time are reset.

The date format can be switched from the display of day, month, year (*dd.mm.yyyy*) to the display of month, day, year (*mm/dd/yyyy* or *mm.dd.yyyy*).

1. In the measured value display:
Open the *Storage & config* menu with **<ENTER__ >**.
The instrument is in the setting mode.
2. Select and confirm the *System / Clock* menu with **<▲><▼>** and **<ENTER>**.
The setting menu for the date and time opens up.
3. Select and confirm the *Time* menu with **<▲><▼>** and **<ENTER>**.
The hours are highlighted.

Clock	
Date format:	dd.mm.yyyy
Date:	15.02.2014
Time:	14:15:25
<div style="display: flex; justify-content: space-between; align-items: center;"> Back <div style="text-align: center;"> 15.02.2014 14:15 </div> </div>	

4. Change and confirm the setting with **<▲><▼>** and **<ENTER>**.
The minutes are highlighted.
5. Change and confirm the setting with **<▲><▼>** and **<ENTER>**.
The seconds are highlighted.
6. Change and confirm the setting with **<▲><▼>** and **<ENTER>**.
The time is set.
7. If necessary, set the *Date* and *Date format*. The setting is made similarly to that of the time.
8. To make further settings, switch to the next higher menu level with **[Back]<F1>**.
or
Switch to the measured value display with **<M>**.
The instrument is in the measuring mode.

4.5 Channel display

The Multi 3320 manages the connected sensors and displays which sensor is plugged to which connection.

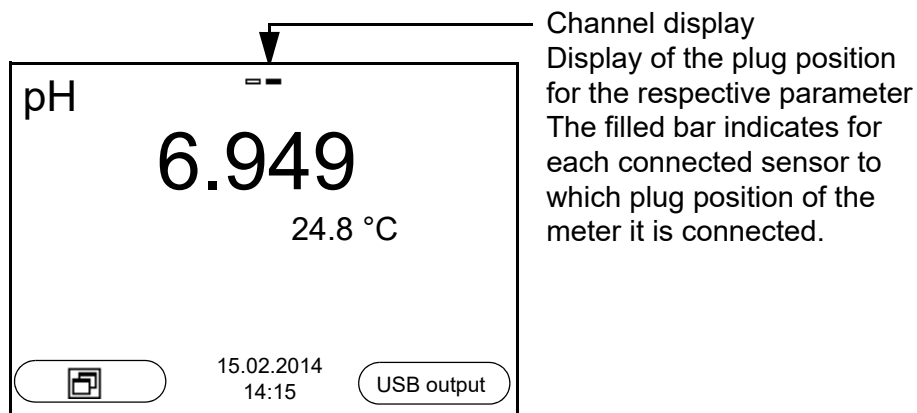

4.5.1 Display of several sensors in the measuring mode

The measured values of the connected sensors can be displayed in the following ways:

- Clear display of all connected sensors
- Detailed display of one sensor

With the softkey you can very easily switch between the two display types. The suitable softkey is displayed depending on the operating situation.

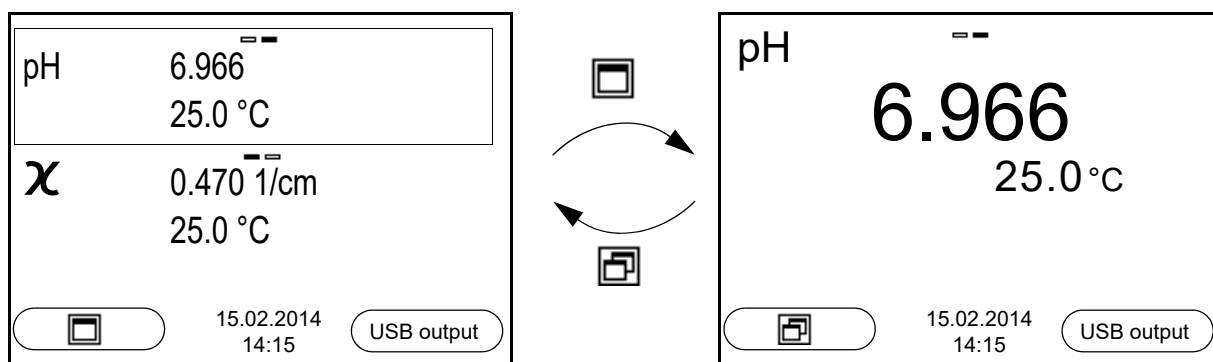

5 pH value

5.1 Measuring

5.1.1 Measuring the pH value

NOTE

When connecting an grounded PC/printer, measurements cannot be performed in grounded media as the values would be incorrect. The USB interface is not galvanically isolated.



To ensure the high measurement accuracy of the measuring system, always measure with a calibrated electrode (see section 5.2 CALIBRATION, page 25).

1. Connect the pH electrode to the meter.
2. If necessary, select the measured parameter with **<M>**.
3. When measuring without temperature sensor:
 - Temper the test sample, or measure the current temperature.
 - Enter the temperature value in the menu.
4. Immerse the pH electrode in the test sample. The measured value is checked for stability (automatic stability control). The display of the measured parameter flashes.
5. Wait for a stable measured value. The display of the measured parameter no longer flashes.

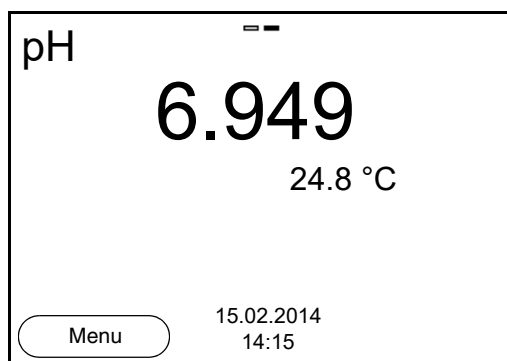

Stability control (AutoRead)

The stability control function (*AutoRead*) continually checks the stability of the measurement signal. The stability has a considerable impact on the reproducibility of measured values (see section 10.2.3 AUTOMATIC STABILITY CONTROL, page 71).

Criteria for a stable measured value

The *Stability control* function checks whether the measured values are stable

within the monitored time interval.

Measured parameter	Time interval	Stability in the time interval
pH value	15 seconds	Δ : better than 0.01 pH
Temperature	15 seconds	Δ : better than 0.5 °C

The minimum duration until a measured value is assessed as stable is the monitored time interval. The actual duration is mostly longer.

Freezes the measured value (HOLD function)

With the HOLD function, you can freeze the current measured value. The displayed measured value stops changing until you switch the HOLD function off.

1. Freeze the measured value with **<AR>**.
The [HOLD] status indicator is displayed.
2. Release the frozen measured value again with **<AR>**.
The HOLD function is switched off.
The [HOLD] status display disappears.

5.1.2 Measuring the temperature

For reproducible pH measurements, it is essential to measure the temperature of the test sample.

You have the following options to measure the temperature:

- Automatic measurement of the temperature with the temperature sensor (NTC30 or Pt1000) integrated in the sensor.
- Manual determination and input of the temperature.

The measuring instrument recognizes whether a suitable sensor is connected and automatically switches on the temperature measurement.

The display of the temperature indicates the active temperature measuring mode:

Temperature sensor	Resolution of the temp. display	Temp. measurement
yes	0.1 °C	Automatic with temperature sensor
-	1 °C	Manual

If you wish to measure (or calibrate) without temperature sensor, proceed as follows:

1. Measure the current temperature of the test sample.
2. In the **<ENTER>/pH/Man. temperature** menu, set the temperature value with **<▲><▼>**.

5.2 Calibration

5.2.1 Why calibrate?

pH electrodes age. This changes the zero point (asymmetry) and slope of the pH electrode. As a result, an inexact measured value is displayed. Calibration determines and stores the current values of the zero point and slope of the electrode.

Thus, you should calibrate at regular intervals.

5.2.2 When do you have to calibrate?

- After connecting a sensor
- Routinely within the framework of the company quality assurance
- When the calibration interval has expired

5.2.3 Automatic calibration (AutoCal)

Make sure that in the sensor menu, *Buffer* menu, the buffer set is correctly selected (see 10.1.1 SETTINGS FOR PH MEASUREMENTS, PAGE 57).

Use any one to five buffer solutions of the selected buffer set in ascending or descending order.

Below, calibration with Technical buffers (*TEC*) is described. When other buffer sets are used, other nominal buffer values are displayed. Apart from that, the procedure is identical.



If single-point calibration was set in the menu, the calibration procedure is automatically finished with the measurement of buffer solution 1 and the calibration record is displayed.

1. Connect the pH electrode to the meter.
2. When measuring without temperature sensor:
 - Temper the buffer solution, or measure the current temperature.
 - Enter the temperature value in the menu.
3. In the measured value display, select the measured parameter pH or mV with **<M>**.
4. Start the calibration with **<CAL>**.
The calibration display for the first buffer appears (voltage display).

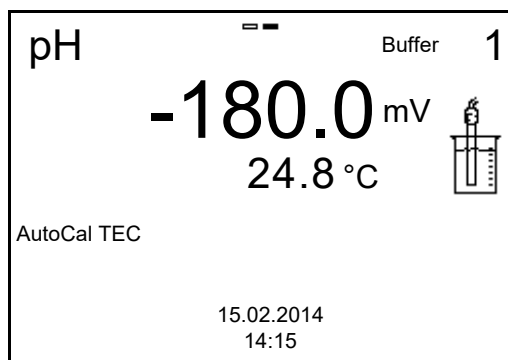

5. Thoroughly rinse the electrode with deionized water.
6. Immerse the electrode in the first buffer solution.
7. When measuring without temperature sensor:
 - Temper the buffer solution, or measure the current temperature.
 - Enter the temperature value in the menu.
8. Start the measurement with **<ENTER>**.
The measured value is checked for stability (stability control). The [AR] status indicator is displayed. A progress bar is displayed and the display of the measured parameter flashes.

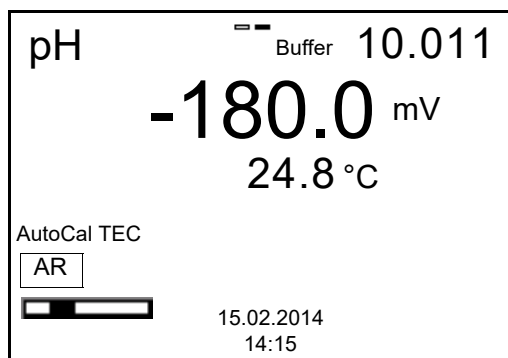

9. Wait for the end of the measurement with stability control or accept the calibration value with **<ENTER>**.
The calibration display for the next buffer appears (voltage display).
10. If necessary, finish the calibration procedure as a single-point calibration with **<M>**.
The calibration record is displayed.



For **single-point calibration**, the instrument uses the Nernst slope (-59.2 mV/pH at 25 °C) and determines the zero point of the electrode.

Continuing with two-point calibration

11. Thoroughly rinse the electrode with deionized water.
12. Immerse the electrode in the second buffer solution.

13. When measuring without temperature sensor:
 - Temper the buffer solution, or measure the current temperature.
 - Enter the temperature value in the menu.
14. Start the measurement with **<ENTER>**.
The measured value is checked for stability (stability control). The [AR] status indicator is displayed. A progress bar is displayed and the display of the measured parameter flashes.

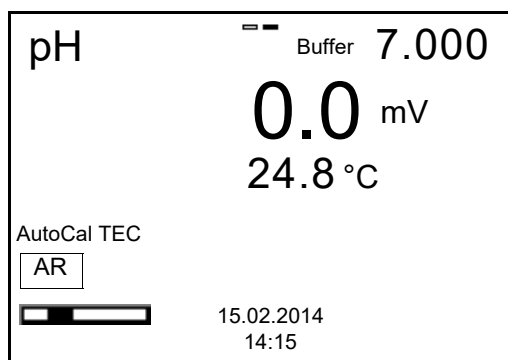

15. Wait for the measurement with stability control to be completed or terminate the stability control and take over the calibration value with **<ENTER>**.
The calibration display for the next buffer appears (voltage display).
16. If necessary, finish the calibration procedure as a two-point calibration with **<M>**.
The calibration record is displayed.

Continuing with three- to five-point calibration

17. Thoroughly rinse the electrode with deionized water.
18. Immerse the electrode in the next buffer solution.
19. When measuring without temperature sensor:
 - Temper the buffer solution, or measure the current temperature.
 - Enter the temperature value in the menu.
20. Start the measurement with **<ENTER>**.
The measured value is checked for stability (stability control). The [AR] status indicator is displayed. A progress bar is displayed and the display of the measured parameter flashes.

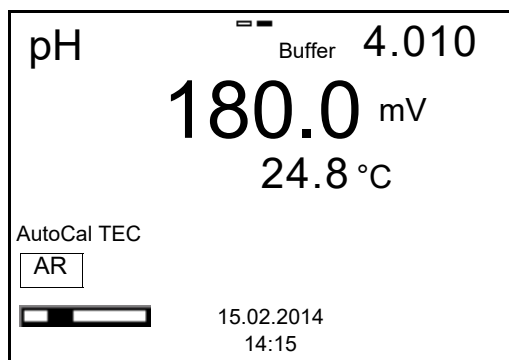

21. Wait for the measurement with stability control to be completed or terminate the stability control and take over the calibration value with **<ENTER>**.
The calibration display for the next buffer appears (voltage display).
22. If necessary, use **<M>** to finish calibration or
Continue calibrating using the next buffer with **<ENTER>**.



Calibration is automatically completed after the last buffer of a buffer set has been measured. Then the calibration record is displayed.

The calibration line is determined by linear regression.

5.2.4 Manual calibration (ConCal)

Make sure that in the sensor menu, *Buffer* menu, the ConCal buffer set is correctly selected (see section 10.1.1 SETTINGS FOR PH MEASUREMENTS, page 57).

Use any one to five buffer solutions in ascending or descending order.



If single-point calibration was set in the menu, the calibration procedure is automatically finished with the measurement of buffer solution 1 and the calibration record is displayed.

1. Connect the pH electrode to the meter.
The pH measuring window is displayed.
2. When measuring without temperature sensor:
 - Temper the buffer solution, or measure the current temperature.
 - Enter the temperature value in the menu.
3. In the measured value display, select the measured parameter pH or mV with **<M>**.
4. Start the calibration with **<CAL>**.
The calibration display appears (voltage display).

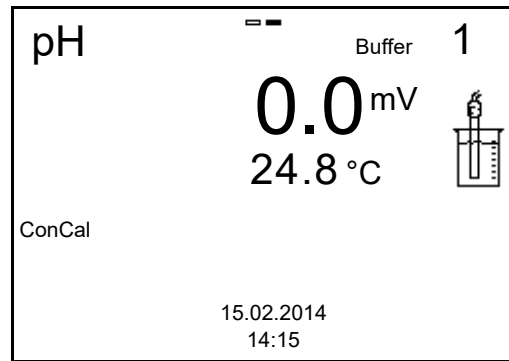

5. Thoroughly rinse the electrode with deionized water.
6. Immerse the electrode in the first buffer solution.
7. When measuring without temperature sensor:
 - Temper the buffer solution, or measure the current temperature.
 - Enter the temperature value in the menu.
8. Start the measurement with **<ENTER>**.
 The measured value is checked for stability (stability control). The [AR] status indicator is displayed. A progress bar is displayed and the display of the measured parameter flashes.

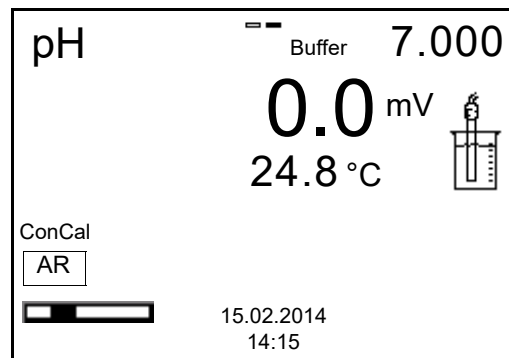

9. Wait for the end of the measurement with stability control or accept the calibration value with **<ENTER>**.
 The calibration display for the setting of the nominal buffer value appears.

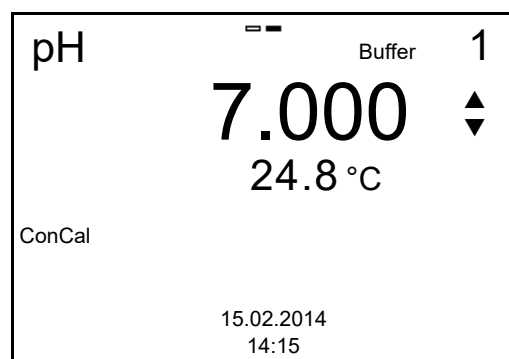

10. Set the nominal buffer value for the measured temperature with **<▲ ><▼ >**.

11. Accept the set calibration value with **<ENTER>**.
The calibration display for the next buffer appears (voltage display).
12. If necessary, finish the calibration procedure as a single-point calibration with **<M>**.
The calibration record is displayed.



For **single-point calibration**, the instrument uses the Nernst slope (-59.2 mV/pH at 25 °C) and determines the zero point of the electrode.

Continuing with two-point calibration

13. Thoroughly rinse the electrode with deionized water.
14. Immerse the electrode in the second buffer solution.
15. When measuring without temperature sensor:
 - Temper the buffer solution, or measure the current temperature.
 - Enter the temperature value in the menu.
16. Start the measurement with **<ENTER>**.
The measured value is checked for stability (stability control). The [AR] status indicator is displayed. A progress bar is displayed and the display of the measured parameter flashes.
17. Wait for the measurement with stability control to be completed or terminate the stability control and take over the calibration value with **<ENTER>**.
The calibration display for the setting of the nominal buffer value appears.

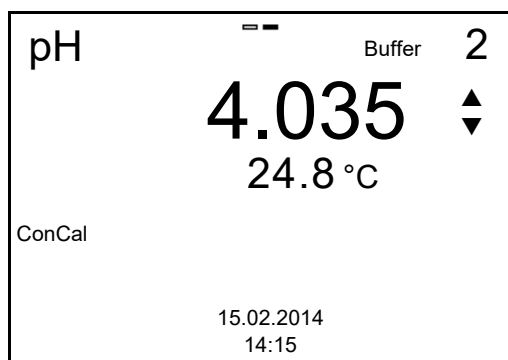

18. Set the nominal buffer value for the measured temperature with **<▲ ><▼ >**.
19. Accept the set calibration value with **<ENTER>**.
The calibration display for the next buffer appears (voltage display).
20. Finish the calibration procedure as a two-point calibration with **<M>**.
The calibration record is displayed.

Continuing with three- to five-point calibration

21. Thoroughly rinse the electrode with deionized water.
22. Immerse the electrode in the next buffer solution.
23. When measuring without temperature sensor:
 - Temper the buffer solution, or measure the current temperature.
 - Enter the temperature value in the menu.
24. Start the measurement with **<ENTER>**.
The measured value is checked for stability (stability control). The [AR] status indicator is displayed. A progress bar is displayed and the display of the measured parameter flashes.
25. Wait for the measurement with stability control to be completed or terminate the stability control and take over the calibration value with **<ENTER>**.
The calibration display for the setting of the nominal buffer value appears.

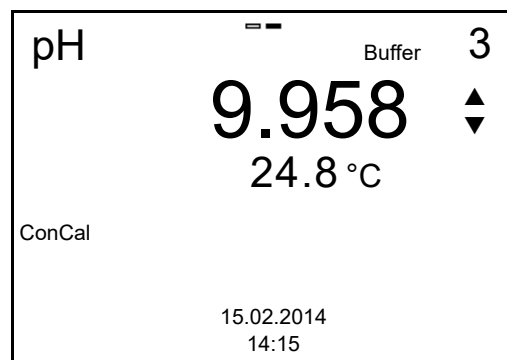

26. Set the nominal buffer value for the measured temperature with **<▲ ><▼ >**.
27. Accept the set calibration value with **<ENTER>**.
The calibration display for the next buffer appears (voltage display).
28. Use **<M>** to finish calibration or
Continue calibrating using the next buffer with **<ENTER>**.



After the fifth buffer has been measured the calibration is automatically finished. Then the calibration record is displayed.

The calibration line is determined by linear regression.

5.2.5 Calibration points

Calibration can be performed using one to five buffer solutions in any order (single-point to five-point calibration). The meter determines the following values and calculates the calibration line as follows:

	Determined values	Displayed calibration data
1-point	Asy	<ul style="list-style-type: none"> ● Zero point = Asy ● Slope = Nernst slope (-59.2 mV/pH at 25 °C)
2-point	Asy Slp.	<ul style="list-style-type: none"> ● Zero point = Asy ● Slope = Slp.
3-point to 5-point	Asy Slp.	<ul style="list-style-type: none"> ● Zero point = Asy ● Slope = Slp. <p>The calibration line is calculated by linear regression.</p>



You can display the slope in the units, mV/pH or % (see section 10.1.1 SETTINGS FOR PH MEASUREMENTS, page 57).

5.2.6 Calibration data



The calibration record is automatically transmitted to the interface after calibrating.

Displays the calibration data

The calibration record of the last calibration is to be found under the menu item, **<ENTER>** / *Calibration* / *Calibration record*. To open it, press the **<CAL__>** key in the measured value display.

Subsequently, you can transmit the displayed calibration data to the interface, e.g. to a PC, with the **<F2>**/*[USB output]* key.





Displaying the calibration data memory

The calibration records of the last calibrations are to be found in the menu, **<ENTER>** / *Calibration* / *Calibration data storage*.

Menu item	Setting/function	Explanation
<i>Calibration / Calibration data storage / Display</i>	-	Displays the calibration record. Further options: <ul style="list-style-type: none"> ● Scroll through the calibration records with <▲><▼>. ● Output the displayed calibration record to the interface with <F2>/[USB output]. ● Quit the display with <F1>/[Back] or <ENTER>. ● Switch directly to the measured value display with <M>.
<i>Calibration / Calibration data storage / Output to USB</i>	-	Outputs the calibration records to the interface.

Calibration evaluation

After calibrating, the meter automatically evaluates the calibration. The zero point and slope are evaluated separately. The worse evaluation of both is taken into account. The evaluation appears on the display and in the calibration record.

Display	Calibration record	Zero point [mV]	Slope [mV/pH]
	+++	-15 ... +15	-60.5 ... -58.0
	++	-20 ... <-15 or >+15 ... +20	>-58.0 ... -57.0
	+	-25 ... <-20 or >+20 ... +25	-61.0 ... <-60.5 or >-57.0 ... -56.0
	-	-30 ... <-25 or >+25 ... +30	-62.0 ... <-61.0 or >-56.0 ... -50.0
Clean the electrode according to the electrode operating manual			
<i>Error</i>	<i>Error</i>	<-30 oder >+30	<-62.0 oder >-50.0
Error elimination (see section 14 WHAT TO DO IF..., page 86)			

**Calibration record
(example)**

```
Multi 3320
Ser. no. 11292113

CALIBRATIONpH
15.02.2014 15:55

AutoCal TEC
Buffer 1          4.01
Buffer 2          7.00
Buffer 3          10.01
Voltage 1         184.0 mV
Voltage 2         3.0 mV
Voltage 3         -177.0 mV
Temperature 1     24.0 °C
Temperature 2     24.0 °C
Temperature 3     24.0 °C
Slope             -60.2 mV/pH
Asymmetry         4.0 mV
Sensor            +++

etc...
```

5.2.7 Continuous measurement control (CMC function)

The Continuous Measurement Control (CMC function) facilitates to evaluate the current measured value instantly and definitely.

After each successful calibration the scale of the pH measuring range is displayed in the measured value display. Here you can very clearly see whether or not the current measured value is in the calibrated part of the measuring range.

The following information is displayed:

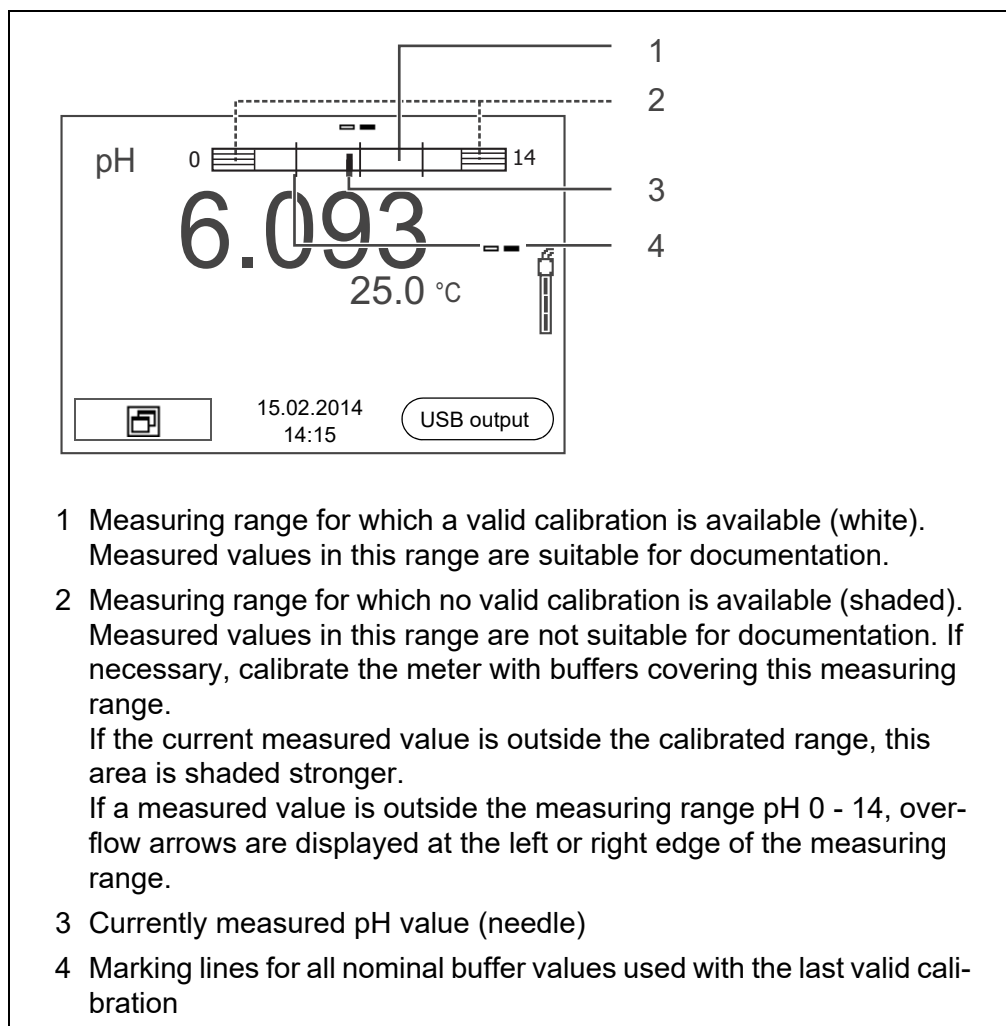

The limits of the calibrated range are determined by the buffers used for calibration:

Lower limit: Buffer with lowest pH value - 2 pH units
 Upper limit: Buffer with highest pH value + 2 pH units

6 ORP voltage

6.1 Measuring

6.1.1 Measuring the ORP

NOTE

When connecting an grounded PC/printer, measurements cannot be performed in grounded media as the values would be incorrect. The USB interface is not galvanically isolated.

1. Connect the ORP electrode to the meter.
2. If necessary, select the U (mV) display with **<M>**.
3. When measuring without temperature sensor:
 - Temper the test sample, or measure the current temperature.
 - Enter the temperature value in the menu.
4. Rinse the ORP electrode and immerse it in the test sample. The measured value is checked for stability (automatic stability control). The display of the measured parameter flashes.
5. Wait for a stable measured value. The display of the measured parameter no longer flashes.

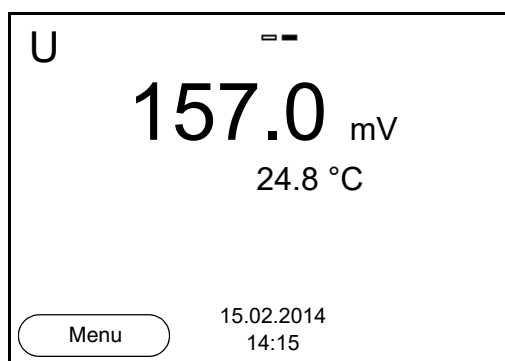

Stability control (AutoRead)

The stability control function (*AutoRead*) continually checks the stability of the measurement signal. The stability has a considerable impact on the reproducibility of measured values (see section 10.2.3 AUTOMATIC STABILITY CONTROL, page 71).

Criteria for a stable measured value

The *Stability control* function checks whether the measured values are stable within the monitored time interval.

Measured parameter	Time interval	Stability in the time interval
ORP	15 seconds	Δ : better than 0.3 mV
Temperature	15 seconds	Δ : better than 0.5 °C

The minimum duration until a measured value is assessed as stable is the monitored time interval. The actual duration is mostly longer.

Freezes the measured value (HOLD function)

With the HOLD function, you can freeze the current measured value. The displayed measured value stops changing until you switch the HOLD function off.

1. Freeze the measured value with **<AR>**.
The [HOLD] status indicator is displayed.
2. Release the frozen measured value again with **<AR>** or **<M>**.
The HOLD function is switched off.
The [HOLD] status display disappears.

6.1.2 Measuring the temperature

For reproducible ORP measurements, it is essential to measure the temperature of the test sample.

You have the following options to measure the temperature:

- Automatic measurement of the temperature by the temperature sensor (NTC30 or Pt1000) integrated in electrode.
- Manual determination and input of the temperature.

The measuring instrument recognizes whether a suitable sensor is connected and automatically switches on the temperature measurement.

The display of the temperature indicates the active temperature measuring mode:

Temperature sensor	Resolution of the temp. display	Temp. measurement
yes	0.1 °C	Automatic with temperature sensor
-	1 °C	Manual

If you wish to measure without temperature sensor, proceed as follows:

1. Measure the current temperature of the test sample.
2. Set the temperature value with **<▲><▼>**.
or
In the **<ENTER>/U/Man. temperature** menu, set the temperature value with **<▲><▼>**.

6.2 ORP calibration

ORP electrodes are not calibrated. You can, however, check ORP electrodes by measuring the ORP of a test solution and comparing the value with the nominal value.

7 Ion concentration

7.1 Measuring

7.1.1 Measuring the ion concentration

NOTE

When connecting an grounded PC/printer, measurements cannot be performed in grounded media as the values would be incorrect. The USB interface is not galvanically isolated.



Incorrect calibration of ion sensitive electrodes will result in incorrect measured values. Calibrate regularly before measuring.



For precise ISE measurements the temperature difference between measurement and calibration should not be greater than 2 K. Therefore, adjust the temperature of the standard and measuring solutions accordingly. If the temperature difference is greater the [TempErr] warning appears in the measured value display.

1. Connect the ISE electrode to the meter.
The pH/U/ISE measuring window is displayed.
2. If necessary, select the ISE display (unit, mg/l) with <M>.
3. When measuring without temperature sensor:
 - Temper the test sample, or measure the current temperature.
4. Calibrate or check the meter with the electrode.



While no valid calibration is available, e.g. in the delivery condition, "Error" appears in the measured value display.

5. Immerse the electrode in the test sample.

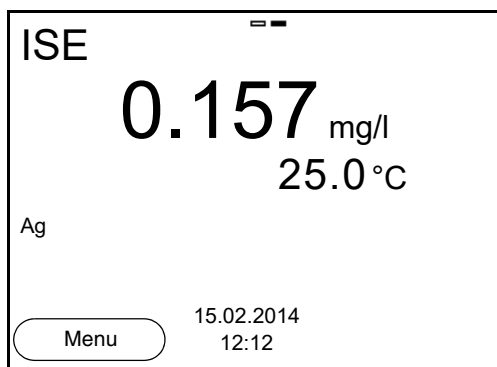

Stability control (AutoRead)

The stability control function (*AutoRead*) continually checks the stability of the measurement signal. The stability has a considerable impact on the reproducibility of measured values (see section 10.2.3 AUTOMATIC STABILITY CONTROL,

page 71).

Criteria The AutoRead criteria affect the reproducibility of the measured values. The following criteria can be adjusted:

- *high*: highest reproducibility
- *medium*: medium reproducibility
- *low*: lowest reproducibility



Increasing reproducibility also causes the response time to increase until a measured value is evaluated as stable.

Freezes the measured value (HOLD function)

With the HOLD function, you can freeze the current measured value. The displayed measured value stops changing until you switch the HOLD function off.

1. Freeze the measured value with **<AR>**.
The [HOLD] status indicator is displayed.
2. Release the frozen measured value again with **<AR>**.
The HOLD function is switched off.
The [HOLD] status display disappears.

7.1.2 Measuring the temperature

For reproducible ion-selective measurements, it is essential to measure the temperature of the test sample.

You have the following options to measure the temperature:

- Measurement by an external temperature sensor.
- Manual determination and input of the temperature.

The measuring instrument recognizes whether a suitable sensor is connected and automatically switches on the temperature measurement.

The display of the temperature indicates the active temperature measuring mode:

Temperature sensor	Resolution of the temp. display	Temp. measurement
yes	0.1 °C	Automatic with temperature sensor
-	1 °C	Manual

If you wish to measure (or calibrate) without temperature sensor, proceed as follows:

1. Measure the current temperature of the test sample.

2. When measuring without temperature sensor:
 - Temper the test sample, or measure the current temperature.

7.2 Calibration

7.2.1 Why calibrate?

Ion-selective electrodes age and are temperature-dependent. This changes the slope. As a result, an inexact measured value is displayed. Calibration determines the calibration line of the electrode and stores this value in the meter.

Thus, you should calibrate before each measurement (if possible), and at regular intervals.

7.2.2 When to calibrate?

- Before any measurement if possible
- After connecting another ISE electrode
- When the sensor symbol flashes, e.g. after a voltage interruption (empty batteries)

7.2.3 Calibration (ISE Cal)

ISE Cal is the conventional **two-point** to **seven-point calibration procedure** that uses 2 to 7 freely selectable standard solutions. The concentration expected in the measurement determines the concentration of the calibration standards.

1. Connect the ISE electrode to the meter.
The pH/U/ISE measuring window is displayed.
2. Keep the standard solutions ready.
3. When measuring without temperature sensor:
 - Temper the test sample, or measure the current temperature.
4. In the measured value display, select the ISE measuring window with **<▲ >** **<▼ >** and **<M>**.
5. If necessary, change the unit of the measurement result and calibration standards in the *ISE setup/Unit* menu.
6. Start the calibration with **<CAL>**.
The calibration display appears.

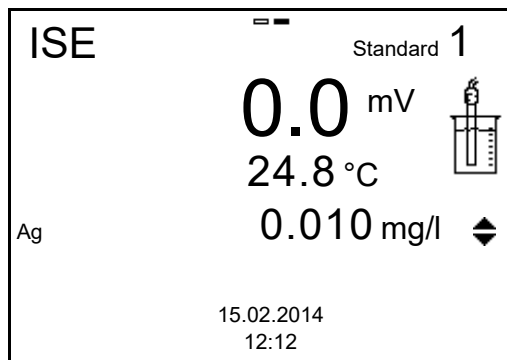

7. Thoroughly rinse the electrode with distilled water.
8. Immerse the electrode in standard solution 1.
9. When calibrating without temperature sensor:
 - Measure the temperature of the standard solution using a thermometer.
 - Use <F2>/[↑] to select the setting of the temperature.
 - Use <▲ > <▼ > to set the temperature.
 - Use <F2>/[↑] to select the setting of the concentration.
10. Set the concentration of the standard solution with <▲ > <▼ > and press <ENTER>. The standard solution is measured. The measured value is checked for stability (AutoRead).

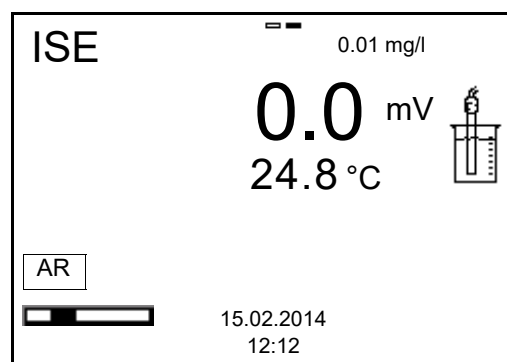

11. Wait for the end of the AutoRead measurement or accept the calibration value with <ENTER>. The calibration display for the next standard solution appears.

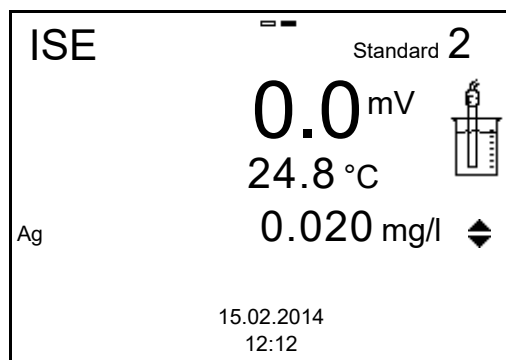

Continuing with two-point calibration

12. Thoroughly rinse the electrode with distilled water.
13. Immerse the electrode in standard solution 2.
14. When calibrating without temperature sensor:
 - Measure the temperature of the standard solution using a thermometer.
 - Use <F2>/[↑↓] to select the setting of the temperature.
 - Use <▲> <▼> to set the temperature.
 - Use <F2>/[↑↓] to select the setting of the concentration.
15. Set the concentration of the standard solution with <▲> <▼> and press <ENTER>. The standard solution is measured. The measured value is checked for stability (AutoRead).

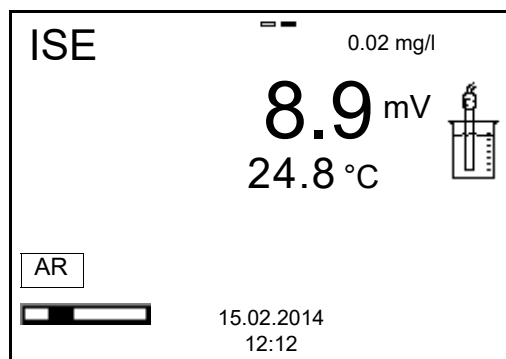

16. Wait for the end of the AutoRead measurement or accept the calibration value with <ENTER>. The calibration display for the next standard solution appears.

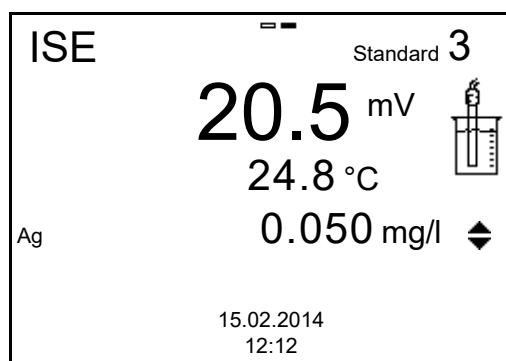

17. Press **<ENTER>** to continue with three-point calibration.
or
Finish the calibration procedure as a two-point calibration with **<M>**.
The new calibration values are displayed.

Continuing with three- to seven-point calibration

Repeat the steps 12 to 17 in the same way with the third and further standard solutions as necessary. The new calibration values are displayed after the last calibration step was completed.



Based on the calibration data, the calibration curve is determined in sections, according to the Nernst equation modified by Nikolski.

7.2.4 Calibration standards

Use two to seven different standard solutions. The standard solutions have to be selected in either increasing or decreasing order.



Select the unit of the standard solution and measurement result in the *ISE setup/Unit* menu.

Standard solution (Std 1 - 7)	Values
Unit [mg/l]	0.010 ... 500.000
Unit [mol/l]	0.100 ... 5.000 µmol/l 10.00 ... 5.000 mmol/l
Unit [mg/kg]	0.010 ... 500.000
Unit [ppm]	0.010 ... 500.000
Unit [%]	0.001 ... 50.000



The measurement precision is also dependent on the selected standard solutions. Therefore, the selected standard solutions should cover the value range expected of the following concentration measurement.

If the measured electrode potential is outside the calibrated range, the *[ISEErr]* warning is displayed.

7.2.5 Calibration data

Displays the calibration data

The calibration record of the last calibration is to be found under the menu item, **<ENTER>** / *Calibration* / *Calibration record*. To open it, press the **<CAL__>** key in the measured value display.

Subsequently, you can transmit the displayed calibration data to the interface, e.g. to a PC, with the **<F2>**/*[USB output]* key.

Displaying the calibration data memory

The calibration records of the last calibrations are available in the menu, **<ENTER>** / Calibration / Calibration data storage.

Menu item	Setting/function	Explanation
Calibration / Calibration data storage / Display	-	Displays the calibration record. Further options: <ul style="list-style-type: none"> ● Scroll through the calibration records with <▲><▼>. ● Output the displayed calibration record to the interface with <F2>/[USB output]. ● Quit the display with <F1>/[Back] or <ENTER>. ● Switch directly to the measured value display with <M>.
Calibration / Calibration data storage / Output to USB	-	Outputs the calibration records to the interface.

Calibration evaluation

After calibrating, the meter automatically evaluates the calibration.

Display	Calibration record	Magnitude of the slope [mV]
	+++	50.0 ... 70.0 or 25.0 ... 35.0
Error	Error	< 50 or > 70 or < 25 or > 35
Error elimination (see section 14 WHAT TO DO IF..., page 86)		

Calibration record (example)

```

Multi 3320
Ser. no. 12345678

CALIBRATIONISE
18.01.2013 08:09:10

Standard 1          0.010 mg/l
Standard 2          0.020 mg/l
Voltage 1           38.5 mV
Voltage 2           58.0 mV
Temperature 1       24.0 øC
Temperature 2       24.0 øC
Ion type            Ag
Slope               64.7 mV
Sensor              +++
    
```

8 Dissolved oxygen

8.1 Measuring

8.1.1 Measuring D.O.

NOTE

When connecting an grounded PC/printer, measurements cannot be performed in grounded media as the values would be incorrect. The USB interface is not galvanically isolated.

1. Connect the D.O. sensor to the meter.
The D.O. measuring screen is displayed.



The measuring instrument automatically recognizes the type of the connected D.O. sensor.

2. If necessary, select the measured parameter with **<M>**.
3. Immerse the D.O. sensor in the test sample.

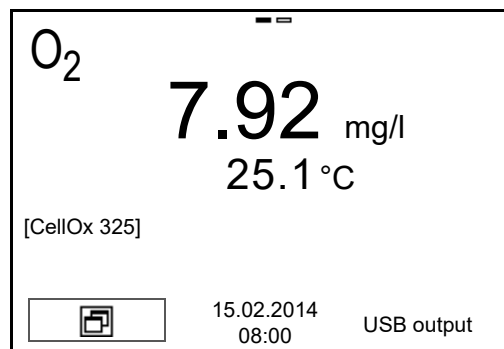

4. If necessary, select the measured parameter with **<M>**.
 - D.O. concentration [mg/l]
 - D.O. saturation [%]
 - D.O. partial pressure [mbar].

Salinity correction

When measuring the concentration of solutions with a salt content of more than 1 g/l, a salinity correction is required. For this, you have to measure and input the salinity of the measured medium first. When the salinity correction is switched on, the *[SAL]* indicator is displayed in the measuring window.



You can switch the salinity correction on or off and enter the salinity in the menu for calibration and measurement settings (see section 10.1.5 SETTINGS FOR ISE MEASUREMENTS, page 62).

Stability control (AutoRead)

The stability control function (*AutoRead*) continually checks the stability of the measurement signal. The stability has a considerable impact on the reproducibility of measured values (see section 10.2.3 AUTOMATIC STABILITY CONTROL, page 71).

Criteria for a stable measured value

The *Stability control* function checks whether the measured values are stable within the monitored time interval.

Measured parameter	Time interval	Stability in the time interval
D.O. concentration	20 seconds	Δ : better than 0.05 mg/l
D.O. saturation	20 seconds	Δ : better than 0.6 %
D.O. partial pressure	20 seconds	Δ : Better than 1.2 mbar
Temperature	15 seconds	Δ : better than 0.5 °C

The minimum duration until a measured value is assessed as stable is the monitored time interval. The actual duration is mostly longer.

Freezes the measured value (HOLD function)

With the HOLD function, you can freeze the current measured value. The displayed measured value stops changing until you switch the HOLD function off.

1. Freeze the measured value with **<AR>**.
The [HOLD] status indicator is displayed.
2. Release the frozen measured value again with **<AR>**.
The HOLD function is switched off.
The [HOLD] status display disappears.

8.1.2 Measuring the temperature

For reproducible D.O. measurements, it is essential to measure the temperature of the test sample.

The temperature is automatically measured by the temperature sensor (NTC30 or Pt1000) integrated in the sensor.



8.2 Calibration

8.2.1 Why calibrate?

D.O. sensors age. This changes the slope of the D.O. sensor. Calibration determines the current slope of the sensor and stores this value in the instrument.

8.2.2 When to calibrate?

- After connecting a sensor
- Routinely within the framework of the company quality assurance
- When the calibration interval has expired

8.2.3 Calibration procedure

The Multi 3320 provides 2 calibration procedures:

- Calibration in water vapor-saturated air.
Use an OxiCal[®] air calibration vessel for the calibration.
- Calibration via a comparison measurement (e.g. Winkler titration according to DIN EN 25813 or ISO 5813). At the same time, the relative slope is adapted to the comparison measurement by a correction factor. When the correction multiplier is active, the *[Factor]* indicator appears in the measuring window.

8.2.4 Calibration in water vapor-saturated air (air calibration vessel)

For this calibration procedure, the *Comparison meas.* setting must be set to *Off* in the *Calibration* menu.

Proceed as follows to calibrate the instrument:

1. Connect the D.O. sensor to the meter.
2. Put the D.O. sensor into the air calibration vessel.



The sponge in the air calibration vessel must be moist (not wet). Leave the sensor in the air calibration vessel for a time long enough to adjust.

3. Start the calibration with **<CAL>**.
The last calibration data (relative slope) is displayed.

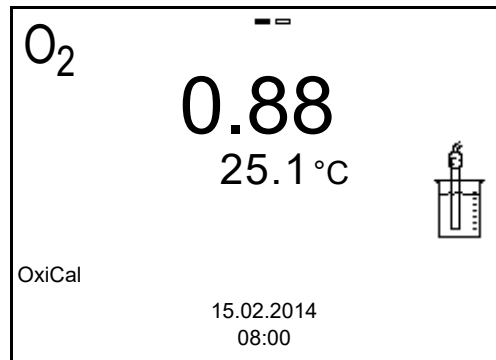

4. Start the measurement with **<ENTER>**.
The measured value is checked for stability (stability control).
The [AR] status indicator is displayed. A progress bar is displayed and the display of the measured parameter flashes.
5. Wait for the end of the measurement with stability control or accept the calibration value with **<ENTER>**.
The calibration record is displayed and output to the interface.
6. Using **<F1>**/*[Continue]* or **<ENTER>**, switch to the measured value display.
The meter displays a D.O. saturation of approx. 101.7 % in the air calibration vessel.

8.2.5 Calibrating with a comparison measurement (OxiComp)

For this calibration procedure, the *Comparison meas.* setting must be set to *On* in the *Calibration* menu.



Before calibrating via a comparison measurement, the sensor should be calibrated in the air calibration vessel.

1. Connect the D.O. sensor to the meter.
2. Immerse the D.O. sensor in the reference solution.
3. Start the calibration with **<CAL>**.

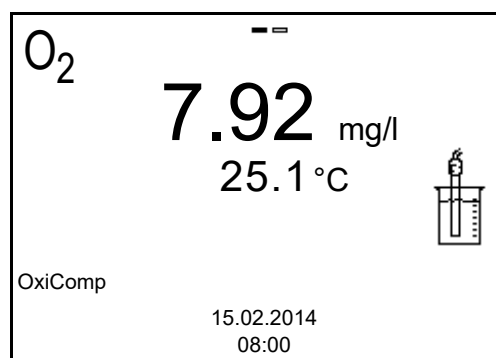

4. Start the measurement with **<ENTER>**.
The measured value is checked for stability (stability control).
The [AR] status indicator is displayed. The measured parameter flashes.
5. Wait for the end of the measurement with stability control or accept the calibration value with **<ENTER>**.
The factor that was set last is displayed.

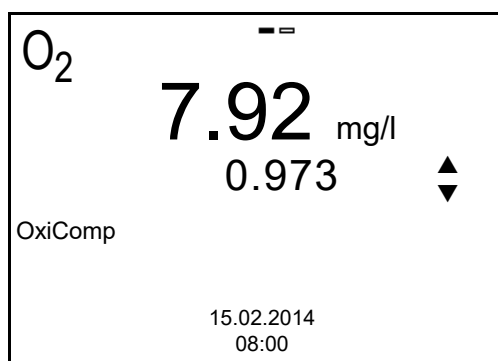

6. Using **<▲ >** **<▼ >**, set the correction factor to adjust the displayed concentration value to the nominal value (value of the comparison measurement). Subsequently, accept the correction factor with **<ENTER>**.
The meter switches to the measured value display.
The status display *[Factor]* is active.

8.2.6 Calibration data



The calibration record is automatically transmitted to the interface after calibrating.

Displays the calibration data

The calibration record of the last calibration is to be found under the menu item, **<ENTER>** / *Calibration* / / *Calibration record*. To open it, press the **<CAL__>** key in the measured value display.

Subsequently, you can transmit the displayed calibration data to the interface, e.g. to a PC, with the **<F2>**[*USB output*] key.



Displaying the calibration data memory

The calibration records of the last calibration procedures are available in the menus, **<ENTER>**/*Calibration* / / *Calibration data storage* and **<ENTER>**/*Storage & config* / *Data storage* / / *Calibration data storage*.

Menu item	Setting/function	Explanation
<i>Calibration</i> / <i>Calibration data storage</i> / <i>Display</i> or <i>Data storage</i> / <i>Calibration data storage</i> / <i>Display</i>	-	Displays the calibration record. Further options: <ul style="list-style-type: none"> ● Scroll through the calibration records with <▲><▼>. ● Output the displayed calibration record to the interface with <F2>[<i>USB output</i>]. ● Quit the display with <F1>/<i>[Back]</i> or <ENTER>. ● Switch directly to the measured value display with <M>.
<i>Calibration</i> / <i>Calibration data storage</i> / <i>Output to USB</i> or <i>Data storage</i> / <i>Calibration data storage</i> / <i>Output to USB</i>	-	Outputs the calibration records to the interface.

Calibration evaluation

After calibration, the meter automatically evaluates the current status of the calibration. The evaluation appears on the display and in the calibration record.

Display	Calibration record	Relative slope
	+++	$S = 0.8 \dots 1.25$
	++	$S = 0.7 \dots 0.8$
	+	$S = 0.6 \dots 0.7$
<i>Error</i> Error elimination (see section 14 WHAT TO DO IF..., page 86)	<i>Error</i>	$S < 0.6$ or $S > 1.25$

Calibration record (example)

```
Multi 3320
Ser. no. 11292113

CALIBRATION Cellox 325
15.02.2014 16:13:33

S = 0.88 25.0 °C
Sensor +++
```

- Set 1 for the type, "Cellox":Cellox 325
- Set 2, for the type "DurOx": DurOx 325

9 Conductivity

9.1 Measuring

9.1.1 Measuring the conductivity

NOTE

When connecting an grounded PC/printer, measurements cannot be performed in grounded media as the values would be incorrect. The USB interface is not galvanically isolated.

1. Connect the conductivity measuring cell to the measuring instrument. The conductivity measuring screen is displayed.
2. If necessary, select the measured parameter with **<M>**.
3. Check the *Measuring cell* settings and cell constant for the connected conductivity measuring cell. If necessary, correct the settings.



The selection of the measuring cell and the setting of the cell constant is done in the measurement settings menu for conductivity (see section 10.1.8 SETTINGS FOR CONDUCTIVITY MEASURING CELLS, page 66). The cell constant to be set must either be taken from the operating manual of the measuring cell or is printed on the measuring cell.

4. Immerse the conductivity measuring cell in the test sample.

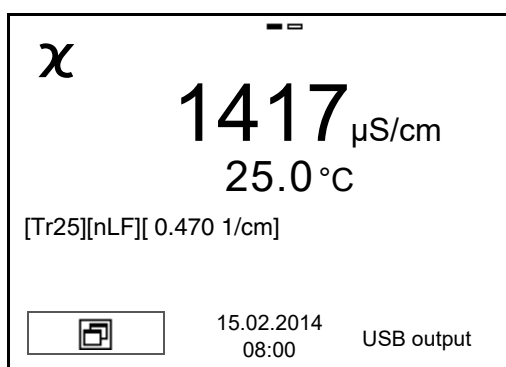

5. If necessary, select the measured parameter with **<M>**.
 - Conductivity [$\mu\text{S}/\text{cm}$] / [mS/cm]
 - Resistivity [$\Omega\cdot\text{cm}$] / [$\text{k}\Omega\cdot\text{cm}$] / [$\text{M}\Omega\cdot\text{cm}$]
 - Salinity SaL []
 - Total dissolved solids TDS [mg/l] / [g/l]



The factor to calculate the total dissolved solids is set to 1.00 in the factory. You can adjust this factor to meet your requirements in the range 0.40 ... 1.00. The factor is set in the *Measurement* menu for the parameter, TDS.

Stability control (AutoRead)

The stability control function (*AutoRead*) continually checks the stability of the measurement signal. The stability has a considerable impact on the reproducibility of measured values (see section 10.2.3 AUTOMATIC STABILITY CONTROL, page 71).

Criteria for a stable measured value

The *Stability control* function checks whether the measured values are stable within the monitored time interval.

Measured parameter	Time interval	Stability in the time interval
Conductivity χ	10 seconds	Δ : better than 1.0% of measured value
Temperature	15 seconds	Δ : better than 0.5 °C

The minimum duration until a measured value is assessed as stable is the monitored time interval. The actual duration is mostly longer.

Freezes the measured value (HOLD function)

With the HOLD function, you can freeze the current measured value. The displayed measured value stops changing until you switch the HOLD function off.

1. Freeze the measured value with **<AR>**.
The [HOLD] status indicator is displayed.
2. Release the frozen measured value again with **<AR>**.
The HOLD function is switched off.
The [HOLD] status display disappears.

9.1.2 Measuring the temperature

For reproducible conductivity measurements, it is essential to measure the temperature of the test sample.

The temperature is automatically measured by the temperature sensor (NTC30 or Pt1000) integrated in the sensor.



The conductivity sensor KLE 325 has an integrated temperature sensor.

9.2 Calibration

9.2.1 Why calibrate?

Aging slightly changes the cell constant, e.g. due to coatings. As a result, an inexact measured value is displayed. The original characteristics of the cell can often be restored by cleaning the cell. Calibration determines the current value of the cell constant and stores this value in the meter.

Thus, you should calibrate at regular intervals (we recommend: every 6 months).

9.2.2 When to calibrate?

- After connecting a sensor
- Routinely within the framework of the company quality assurance
- When the cleaning interval has expired

9.2.3 Determining the cell constant (calibration in control standard)

You can determine the actual cell constant of the conductivity measuring cell by calibrating with the control standard in the following ranges:

- 0.450 ... 0.500 cm⁻¹
(e.g. TetraCon 325 with a nominal cell constant of 0.475 cm⁻¹)
- 0.800 ... 0.880 cm⁻¹
(e.g. KLE 325 with a nominal cell constant of 0.840 cm⁻¹)

The cell constant is determined in the control standard, 0.01 mol/l KCl. Cell constants outside the ranges quoted above cannot be calibrated.

In the default condition, the calibrated cell constant of the meter is set to 0.475 cm⁻¹ (conductivity sensor TetraCon 325).

For this calibration procedure, the *Measuring cell* setting must be set to cal in the *Measurement* menu. Proceed as follows to determine the cell constant:

1. Connect the conductivity measuring cell to the measuring instrument.
2. In the measured value display, select the conductivity parameter with **<M>**.
3. Start the calibration with **<CAL>**.
The cell constant that was calibrated last is displayed.

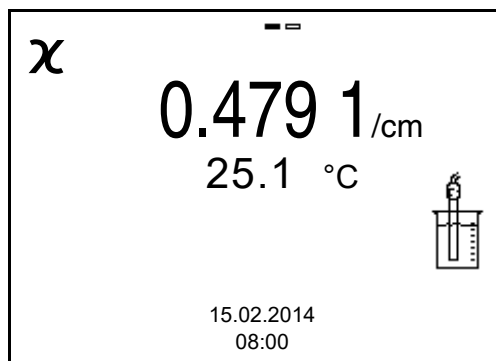

4. Immerse the conductivity measuring cell in the control standard solution, 0.01 mol/l KCl.
5. Start the measurement with **<ENTER>**.
The [AR] status indicator is displayed. A progress bar is displayed and the display of the measured parameter flashes.
6. Wait for the end of the measurement with stability control or accept the calibration value with **<ENTER>**.
The calibration record is displayed and output to the interface.
7. Using **<F1>**/*[Continue]* or **<ENTER>**, switch to the measured value display.

9.2.4 Calibration data



The calibration record is automatically transmitted to the interface after calibrating.

Displays the calibration data

The calibration record of the last calibration is to be found under the menu item, **<ENTER>** / *Calibration* / *Calibration record*. To open it, press the **<CAL__>** key in the measured value display.

Subsequently, you can transmit the displayed calibration data to the interface, e.g. to a PC, with the **<F2>**/*[USB output]* key.

Displaying the calibration data memory

The calibration records of the last calibration procedures are available in the **<ENTER>**/*Calibration* / *Calibration data storage* and **<ENTER>**/*Storage & config* / *Data storage* / *Calibration data storage* menu.

Menu item	Setting/function	Explanation
<i>Calibration / Calibration data storage / Display</i> or <i>Data storage / Calibration data storage / Display</i>	-	Displays the calibration record. Further options: <ul style="list-style-type: none"> ● Scroll through the calibration records with <▲><▼>. ● Output the displayed calibration record to the interface with <F2>/[USB output]. ● Quit the display with <F1>/[Back] or <ENTER>. ● Switch directly to the measured value display with <M>.
<i>Calibration / Calibration data storage / Output to USB</i> or <i>Data storage / Calibration data storage / Output to USB</i>	-	Outputs the calibration records to the interface.

Calibration evaluation

After calibration, the meter automatically evaluates the current status of the calibration. The evaluation appears on the display and in the calibration record.

Display	Calibration record	Cell constant [cm ⁻¹]
	+++	within the ranges 0.450 ... 0.500 cm ⁻¹ or 0.800 ... 0.880 cm ⁻¹
Error Error elimination (see section 14 WHAT TO DO IF..., page 86)	Error	outside the ranges 0.450 ... 0.500 cm ⁻¹ or 0.800 ... 0.880 cm ⁻¹

Calibration record (example)

Multi 3320		
Ser. no. 11292113		
CALIBRATION Cond		
15.02.2014 16:13:33		
Cell constant	0.479 1/cm	25.0 °C
Sensor	+++	

10 Settings

10.1 Measurement settings

10.1.1 Settings for pH measurements

The settings for pH measurements are made in the menu for calibration and measurement settings of the pH/ORP measurement. To open the settings, display the required measured parameter in the measured value display and press the **<ENTER>** key. After completing the settings, switch to the measured value display with **<M>**.

In the following table, only those settings are listed that concern the pH measurement.

Default settings are printed in **bold**.

Menu item	Possible setting	Explanation
<i>Calibration / Calibration record</i>	-	Displays the calibration record of the last calibration.
<i>Calibration / Calibration data storage / Display</i>	-	Displays the calibration record. Further options: <ul style="list-style-type: none"> ● Scroll through the calibration records with <▲><▼>. ● Output the displayed calibration record to the interface with <F2>/[USB output]. ● Output all calibration records to the interface with <F2__>/[USB output]. ● Quit the display with <F1>/[Back] or <ENTER>. ● Switch directly to the measured value display with <M>.
<i>Calibration / Calibration data storage / Output to USB</i>	-	Outputs the calibration records to the interface.
<i>Calibration / Buffer</i>	TEC NIST/DIN ConCal ...	Buffer sets to be used for pH calibration (see section 5.2 CALIBRATION, page 25).
<i>Calibration / One point calibration</i>	Yes No	Quick calibration with 1 buffer

Menu item	Possible setting	Explanation
<i>Calibration / Calibration interval</i>	1 ... 7 ... 999 d	<i>Calibration interval</i> for the pH electrode (in days). The meter reminds you to calibrate regularly by the flashing sensor symbol in the measuring screen.
<i>Calibration / Unit for slope</i>	mV/pH %	Unit of the slope. The % display refers to the Nernst slope of -59.2 mV/pH (100 x determined slope/Nernst slope).
<i>Alternative temperature</i>	On Off	Takes the temperature value from the 2nd sensor.
<i>Man. temperature</i>	-25 ... +25 ... +130 °C	Entry of the manually determined temperature. For measurements without temperature sensor only.
<i>Resolution pH</i>	0.001 0.01 0.1	Resolution of the pH display
<i>Reset</i>	-	Resets all sensor settings to the delivery condition (see section 10.3.1 RESETTING THE MEASUREMENT SETTINGS, page 72).

10.1.2 Buffer sets for calibration

You can use the buffer sets quoted in the table for an automatic calibration. The pH values are valid for the specified temperature values. The temperature dependence of the pH values is taken into consideration during calibration.

No.	Buffer set *	pH values	at
1	ConCal	Any	Any
2	<i>NIST/DIN</i> DIN buffers according to DIN 19266 and NIST Traceable Buffers	1.679 4.006 6.865 9.180 12.454	25 °C
3	<i>TEC</i> WTW Technical buffers	2.000 4.010 7.000 10.011	25 °C
4	<i>Merck 1*</i>	4.000 7.000 9.000	20°C

No.	Buffer set *	pH values	at
5	<i>Merck 2 *</i>	1.000 6.000 8.000 13.000	20°C
6	<i>Merck 3 *</i>	4.660 6.880 9.220	20°C
7	<i>Merck 4 *</i>	2.000 4.000 7.000 10.000	20°C
8	<i>Merck 5 *</i>	4.010 7.000 10.000	25 °C
9	<i>DIN 19267</i>	1.090 4.650 6.790 9.230	25 °C
10	<i>Mettler Toledo USA *</i>	1.679 4.003 7.002 10.013	25 °C
11	<i>Mettler Toledo EU *</i>	1.995 4.005 7.002 9.208	25 °C
12	<i>Fisher *</i>	2.007 4.002 7.004 10.002	25 °C
13	<i>Fluka BS *</i>	4.006 6.984 8.957	25 °C
14	<i>Radiometer *</i>	1.678 4.005 7.000 9.180	25 °C
15	<i>Baker *</i>	4.006 6.991 10.008	25 °C
16	<i>Metrohm *</i>	3.996 7.003 8.999	25 °C

No.	Buffer set *	pH values	at
17	<i>Beckman</i> *	4.005 7.005 10.013	25 °C
18	<i>Hamilton Duracal</i> *	4.005 7.002 10.013	25 °C
19	<i>Precisa</i> *	3.996 7.003 8.999	25 °C
20	<i>Reagecon TEC</i> *	2.000 4.010 7.000 10.000	25 °C
21	<i>Reagecon 20</i> *	2.000 4.000 7.000 10.000 13.000	20°C
22	<i>Reagecon 25</i> *	2.000 4.000 7.000 10.000 13.000	25 °C
23	<i>Chemsolute</i> *	2.000 4.000 7.000 10.000	20°C
24	<i>USABlueBook</i> *	4.000 7.000 10.000	25 °C
25	<i>YSI</i> *	4.000 7.000 10.000	25 °C

* Brand names or trade names are trademarks of their respective owners protected by law.



The buffers are selected in the menu, pH / **<ENTER>** / *Calibration* / *Buffer* (see 10.1.1 SETTINGS FOR PH MEASUREMENTS, PAGE 57).

10.1.3 Calibration interval

The calibration evaluation is displayed as a sensor symbol.

The sensor symbol flashes after the adjusted calibration interval has expired. It is still possible to measure.



To ensure the high measuring accuracy of the measuring system, calibrate after the calibration interval has expired.

Setting the calibration interval

The calibration interval is set to 7 days in the factory. You can change the interval (1 ... 999 days):

1. Open the menu for measurement settings with **<ENTER>**.
2. In the *Calibration / Calibration interval* menu, set the calibration interval with **<▲><▼>**.
3. Confirm the setting with **<ENTER>**.
4. Quit the menu with **<M>**.

10.1.4 Settings for ORP measurements

The settings for ORP measurements are made in the menu for calibration and measurement settings of the pH/ORP measurement. To open the settings, display the required measured parameter in the measured value display and press the **<ENTER>** key. After completing the settings, switch to the measured value display with **<M>**.

In the following table, only those settings are listed that influence the ORP measurement.

Default settings are printed in **bold**.

Menu item	Possible setting	Explanation
<i>Man. temperature</i>	-25 ... +25 ... +130 °C	Entry of the manually determined temperature. For measurements without temperature sensor only.
<i>Resolution mV</i>	0.1 1	Resolution of the mV display
<i>Reset</i>	-	Resets all sensor settings to the delivery condition (see section 10.3.1 RESETTING THE MEASUREMENT SETTINGS, page 72).

10.1.5 Settings for ISE measurements

The settings for ISE measurements are made in the menu for calibration and measurement settings of the ISE measurement. To open the settings, display the required measured parameter in the measured value display and press the **<ENTER>** key. After completing the settings, switch to the measured value display with **<M>**.

In the following table, only those settings are listed that influence the ISE measurement:

Menu item	Possible setting	Explanation
<i>Calibration / Calibration record</i>	-	Displays the calibration record of the last calibration.
<i>Calibration / Calibration data storage / Output to USB</i>	-	Outputs the calibration records to the interface.
<i>Calibration / Calibration data storage / Display</i>	-	<p>Displays the calibration record.</p> <p>Further options:</p> <ul style="list-style-type: none"> ● Scroll through the calibration records with <▲><▼>. ● Output the displayed calibration record to the interface with <F2>/[USB output]. ● Output all calibration records to the interface with <F2__>/[USB output]. ● Quit the display with <F1>/[Back] or <ENTER>. ● Switch directly to the measured value display with <M>.
<i>Alternative temperature</i>	<i>On</i> <i>Off</i>	Takes the temperature value from the 2nd sensor.
<i>Man. temperature</i>	-25 ... +25 ... +130 °C	Entry of the manually determined temperature. For measurements without temperature sensor only.

Menu item	Possible setting	Explanation
<i>ISE setup/ AutoRead criterion</i>	<i>low medium high</i>	Selection of the AutoRead criteria (see section 7.1.1 MEASURING THE ION CONCENTRATION, page 38).
<i>ISE setup/ Ion type</i>	Ag, Br, Ca, Cd, Cl, CN, Cu, F, I, K, Na, NO ₃ , Pb, S, NH ₃ , NH ₄ [*] , CO ₂ , ION * Measuring with the NH 500 electrode: The NH ₄ setting is not suitable for the gas-sensitive electrode NH 500. Select the following settings: <i>Ion type "ION", Valency "-1"</i> .	Selection of the ion type to be measured. An ion that is not included in the list can be measured with the setting, ION.
<i>ISE setup/ Unit</i>	mg/l µmol/l mg/kg ppm %	Selection, with which unit the measurement result and calibration standards should be displayed.
<i>ISE setup/ Ion type/ION</i>	<i>Valency Molar mass</i>	Set the valence (<i>Valency</i>) and molar weight (<i>Molar mass</i>) for the ion.
<i>ISE setup/ Density</i>	0.001 ... 9.999 g/ml or kg/l	Adjustable density of the test sample (only with <i>Unit</i> : mg/kg, ppm, %)

10.1.6 Settings for D.O. sensors

The settings are available in the menu for measurement and calibration settings. To open the settings, display the required measured parameter in the measured value display and press the **<ENTER>** key. After completing the settings, switch to the measured value display with **<M>**.

Default settings are printed in **bold**.

Menu item	Possible setting	Explanation
<i>Calibration / Calibration record</i>	-	Displays the calibration record of the last calibration.
<i>Calibration / Calibration data storage / Display</i>	-	Displays the calibration record. Further options: <ul style="list-style-type: none"> ● Scroll through the calibration records with <▲><▼>. ● Output the displayed calibration record to the interface with <F2>/[USB output]. ● Output all calibration records to the interface with <F2__>/[USB output]. ● Quit the display with <F1>/[Back] or <ENTER>. ● Switch directly to the measured value display with <M>.
<i>Calibration / Calibration data storage / Output to USB</i>	-	Outputs the calibration records to the interface.
<i>Calibration / Calibration interval</i>	1 ... 14 ... 999 d	<i>Calibration interval</i> for the D.O. sensor (in days). The meter reminds you to calibrate regularly by the flashing sensor symbol in the measuring screen.
<i>Calibration / Comparison meas.</i>	On Off	Enables to adjust the measured value with the aid of a comparison measurement, e.g. Winkler titration. For details, see section 8.2 CALIBRATION, page 47.

Menu item	Possible setting	Explanation
<i>Sal correction</i>	<i>On</i> <i>Off</i>	Manual salt content correction for concentration measurements.
<i>Salinity</i>	0.0 ... 70.0	Salinity or salinity equivalent for the salt content correction. This function is only available for concentration measurements if the manual salt content correction is switched on.
<i>Reset</i>	-	Resets all sensor settings to the delivery condition (see section 10.3.1 RESETTING THE MEASUREMENT SETTINGS, page 72).

10.1.7 Calibration interval

The calibration evaluation is displayed as a sensor symbol.

The sensor symbol flashes after the adjusted calibration interval has expired. It is still possible to measure.



To ensure the high measuring accuracy of the measuring system, calibrate after the calibration interval has expired.

Setting the calibration interval

The calibration interval is set to 14 days in the factory. You can change the interval (1 ... 999 days):

1. Open the menu for measurement settings with **<ENTER>**.
2. In the *Calibration / Calibration interval* menu, set the calibration interval with **<▲><▼>**.
3. Confirm the setting with **<ENTER>**.
4. Quit the menu with **<M>**.

10.1.8 Settings for conductivity measuring cells

The settings are made in the *Measurement* menu for the measured parameter, conductivity. To open the settings, display the required measured parameter in the measured value display and press the **<ENTER>** key. After completing the settings, switch to the measured value display with **<M>**.

Default settings are printed in **bold**.

Menu item	Possible setting	Explanation
<i>Calibration / Calibration record</i>	-	Displays the calibration record of the last calibration.
<i>Calibration / Calibration data storage / Display</i>	-	Displays the calibration record. Further options: <ul style="list-style-type: none"> ● Scroll through the calibration records with <▲><▼>. ● Output the displayed calibration record to the interface with <F2>/[USB output]. ● Output all calibration records to the interface with <F2__>/[USB output]. ● Quit the display with <F1>/[Back] or <ENTER>. ● Switch directly to the measured value display with <M>.
<i>Calibration / Calibration data storage / Output to USB</i>	-	Outputs the calibration records to the interface.
<i>Calibration / Calibration interval</i>	1 ... 150 ... 999 d	<i>Calibration interval</i> for the measuring cell (in days). The meter reminds you to calibrate regularly by the flashing sensor symbol in the measuring screen.

Menu item	Possible setting	Explanation
Measurement / Measuring cell / Type	<p>Cal</p> <p><i>LR 325/01</i></p> <p><i>LR 325/001</i></p> <p><i>man</i></p>	<p><i>Measuring cell used</i></p> <p>Measuring cells whose cell constant is determined by calibration in the KCL control standard solution. Calibration ranges: 0.450 ... 0.500 cm⁻¹ and 0.800 ... 0.880 cm⁻¹. The currently valid cell constant is displayed in the status line.</p> <p>Measuring cell LR 325/01, nominal cell constant 0.100 cm⁻¹. The cell constant can be adjusted in the range 0.090 ... 0.110 cm⁻¹.</p> <p>Measuring cell LR 325/001, nominal cell constant 0.010 cm⁻¹. The cell constant is permanently set.</p> <p>Any measuring cells with freely adjustable cell constants.</p>
Measurement / Measuring cell / Cell const. <i>man</i>	0,250 ...	Display and setting option of the cell constant of any measuring cells (<i>man</i>).
Measurement / Measuring cell / Cell const. LR325/ 01	0.090 ... 0.100 ... 0.110 cm ⁻¹	Display and setting options for the cell constant of the measuring cell LR 325/01.
Measurement / Temp. comp. (TC) / Method	nLF <i>Lin</i> <i>Off</i>	Procedure for temperature compensation (see section 10.1.10 TEMPERATURE COMPENSATION, page 68). This setting is only available for the measured parameters, χ and ρ .
Measurement / Temp. comp. (TC) / Linear coeff.	0.000 ... 2.000 ... 10.000 %/K	Coefficient of the linear temperature compensation. This setting is only available when the linear temperature compensation is set.

Menu item	Possible setting	Explanation
<i>Measurement / Temp. comp. (TC) /Reference temp.</i>	20 °C 25 °C	Reference temperature This setting is only available for the measured parameters, χ and ρ .
<i>Measurement / TDS factor</i>	0.40 ... 1.00	Multiplier for TDS value
<i>Reset</i>	-	Resets all sensor settings to the delivery condition (see section 10.3.1 RESETTING THE MEASUREMENT SETTINGS, page 72).

10.1.9 Calibration interval

The calibration evaluation is displayed as a sensor symbol.

The sensor symbol flashes after the adjusted calibration interval has expired. It is still possible to measure.



To ensure the high measuring accuracy of the measuring system, calibrate after the calibration interval has expired.

Setting the calibration interval

The calibration interval is set to 150 days in the factory. You can change the interval (1 ... 999 days):

1. Open the menu for measurement settings with **<ENTER>**.
2. In the *Calibration / Calibration interval* menu, set the calibration interval with **<▲><▼>**.
3. Confirm the setting with **<ENTER>**.
4. Quit the menu with **<M>**.

10.1.10 Temperature compensation

The calculation of the temperature compensation is based on the preset reference temperature, 20 °C or 25 °C. It appears on the display as Tr20 or Tr25.

You can select one of the following temperature compensation methods:

- **Nonlinear temperature compensation (nLF)** according to EN 27 888
- **Linear temperature compensation (lin)** with adjustable coefficient in the range 0.000 ... 10.000 %/K
- **No temperature compensation (off)**



The reference temperature and temperature compensation are set in the *Measurement* menu for the parameter, conductivity (see section 10.1.8 SETTINGS FOR CONDUCTIVITY MEASURING CELLS, page 66).

Application tips Set the temperature compensation suitable for your test sample:

Test sample	Temperature compensation	Display
Natural water (ground water, surface water, drinking water)	<i>nLF</i> according to EN 27 888	<i>nLF</i>
Ultrapure water	<i>nLF</i> according to EN 27 888	<i>nLF</i>
Other aqueous solutions	<i>Lin</i> Set linear temperature coefficient 0.000 ... 10.000 %/K	<i>Lin</i>
Salinity (seawater)	Automatic <i>nLF</i> according to IOT (International Oceanographic Tables)	<i>Sal, nLF</i>

10.1.11 Setting the TDS factor

The factor to calculate the total dissolved solids is set to 1.00 in the delivery condition.

You can adjust this factor to meet your requirements in the range 0.40 ... 1.00.

The factor is set in the menu for the parameter TDS (*Measurement / TDS factor*).

10.2 Sensor-independent settings

10.2.1 System

To open the *Storage & config* menu, press the **<ENTER__ >** key in the measured value display. After completing the settings, switch to the measured value display with **<M>**.

Default settings are printed in **bold**.

Menu item	Possible setting	Explanation
<i>System / General / Language</i>	<i>Deutsch</i> English <i>(more)</i>	Selects the menu language
<i>System / General / Beep</i>	On Off	Switches on/off the beep on keystroke
<i>System / General / Illumination</i>	Auto On Off	Switches the display illumination on/off
<i>System / General / Contrast</i>	0 ... 50 ... 100 %	Changes the display contrast
<i>System / General / Switchoff time</i>	10 min ... 1h ... 24 h	Adjusts the shut-off time
<i>System / General / Temperature unit</i>	°C °F	Temperature unit, degrees Celsius or degrees Fahrenheit. All temperature values are displayed with the selected unit.
<i>System / General / Stability control</i>	On Off	Switches on or off the automatic stability control during measurement
<i>System / Interface / Baud rate</i>	1200, 2400, 4800 , 9600, 19200	Baud rate of the data interface
<i>System / Interface / Output format</i>	ASCII CSV	Output format for data transmission (see section 12 TRANSMITTING DATA (USB INTERFACE), page 81)
<i>System / Interface / Decimal separator</i>	Dot (xx.x) Comma (xx,x)	Decimal separator
<i>System / Interface / Output header</i>		Output of a header for <i>Output format</i> : CSV

Menu item	Possible setting	Explanation
<i>System / Clock</i>	<i>Date format</i> <i>Datum</i> <i>Time</i>	Time and date settings (see section 4.4.6 EXAMPLE 2 ON NAVIGATION: SETTING THE DATE AND TIME, page 20)
<i>System / Service information</i>		Hardware version and software version of the meter are displayed.
<i>System / Reset</i>	-	Resets the system settings to the delivery condition (see section 10.3.2 RESETTING THE SYSTEM SETTINGS, page 74).

10.2.2 Data storage

This menu contains all functions to display, edit and erase stored measured values and calibration records (see section 11 DATA MEMORY, page 75).

10.2.3 Automatic Stability control

The automatic *Stability control* (AutoRead) function continuously checks the stability of the measurement signal. The stability has a considerable impact on the reproducibility of measured values.

You can activate or switch off the automatic *Stability control* function (see section 10.2.1 SYSTEM, page 70).

The measured parameter flashes on the display

- as soon as the measured value is outside the stability range
- when you switch over between the measured parameters with **<M>**.
- when the automatic *Stability control* is switched off.

Manually starting the stability control

Irrespective of the setting for automatic *Stability control* (see section 10.2.1 SYSTEM, page 70) in the *System* menu, you can start the *Stability control* function manually at any time.

1. Freeze the measured value with **<AR>**.
The [HOLD] status indicator is displayed.



If the HOLD function is active, you can, e.g. start a manual measurement with stability control.

2. Using **<ENTER>**, activate the *Stability control* function manually. The [AR] status indicator appears while the measured value is assessed as not stable. A progress bar is displayed and the display of the measured parameter flashes. The [HOLD][AR] status indicator appears as soon as a stable measured value is recognized. The progress bar disappears and the display of the measured parameter stops flashing. The current measurement data is output to the interface. Measurement data meeting the stability control criterion is marked by AR.



You can prematurely terminate the *Stability control* function manually with **<ENTER>** at any time. If the *Stability control* function is prematurely terminated, the current measurement data are output to the interface without the AutoRead info.

3. Using **<ENTER>**, start a further measurement with *Stability control*.
or
Release the frozen measured value again with **<AR>**.
The display switches to the measured value display.
The [AR][HOLD] status display disappears.

10.3 Reset

You can reset (initialize) all sensor settings and sensor-independent settings separately from each other.

10.3.1 Resetting the measurement settings



The calibration data are reset to the default settings together with the measuring parameters. Recalibrate after performing a reset.

The following settings for pH measurements are reset to the default settings with the *Reset* function:

pH

Setting	Default settings
<i>Buffer</i>	<i>TEC</i>
<i>Calibration interval</i>	7 d
<i>Unit for slope</i>	mV/pH
<i>Measured parameter</i>	pH
Resolution pH	0.001
Resolution mV	0.1
Asymmetry	0 mV

Setting	Default settings
Slope	-59.2 mV
<i>Man. temperature</i>	25 °C
<i>One point calibration</i>	No

The sensor settings are reset under the *Reset* menu item in the menu for calibration and measurement settings. To open it in the measured value display, press the **<ENTER>** (or **<F1>/[Menu]**) key.

Oxi



The calibration data are reset to the default settings together with the measuring parameters. Recalibrate after performing a reset.

The following settings for D.O. measurements are reset to the default settings with the *Reset* function:

Setting	Default settings
Kal.-Intervall	14 d
Comparison meas.	Off
<i>Measured parameter</i>	D.O. concentration
<i>Relative slope (S_{Rel})</i>	1.00
<i>Salinity (value)</i>	0,0
<i>Salinity (function)</i>	Off

The sensor settings are reset under the *Reset* menu item in the menu for calibration and measurement settings. To open it in the measured value display, press the **<ENTER>** (or **<F1>/[Menu]**) key.

Cond

The following settings for conductivity measurements are reset to the default settings with the *Reset* function:

Setting	Default settings
<i>Kal.-Intervall</i>	150 d
<i>Measured parameter</i>	χ
<i>Cell constant (C)</i> <i>(calibrated)</i>	0.475 cm ⁻¹ or 0.840 cm ⁻¹ (nominal cell constant of the conductivity measuring cell last calibrated)
<i>Cell constant (C)</i> <i>(set)</i>	0.470 1/cm
<i>Temperature compensation</i>	nLF

Setting	Default settings
<i>Reference temperature</i>	25 °C
<i>Temperature coefficient (TC) of the linear temperature compensation</i>	2.000 %/K
<i>TDS multiplier</i>	1.00

The sensor settings are reset under the *Reset* menu item in the menu for calibration and measurement settings. To open it in the measured value display, press the **<ENTER>** (or **<F1>/[Menu]**) key.

10.3.2 Resetting the system settings

The following system settings can be reset to the default status:

Setting	Default settings
<i>Language</i>	English
<i>Beep</i>	On
<i>Baud rate</i>	4800 Baud
<i>Output format</i>	ASCII
<i>Decimal separator</i>	Dot (xx.x)
<i>Contrast</i>	50 %
<i>Illumination</i>	Auto
<i>Switchoff time</i>	1 h
Stability control	On
Temperature unit	°C

The system settings are reset in the menu, *Storage & config / System / Reset*. To open the *Storage & config* menu in the measured value display, press the **<ENTER__ >** (or **<F1__>/[Menu]**) key.

11 Data memory

You can transmit measured values (datasets) to the data memory:

- Manual data memory (see section 11.1 MANUAL STORAGE, page 75)
- Automatic storage at intervals (see section 11.2 AUTOMATIC DATA STORAGE AT INTERVALS, page 76)



With each data storage process, the current datasets of the sensors indicated on the display are transmitted to the interface at the same time.

11.1 Manual storage

You can transmit a measurement dataset to the data memory as follows. With each data storage process, the current datasets of the sensors indicated on the display are transmitted to the interface at the same time.

1. Press the **<STO>** key shortly.
The menu for manual data storage appears.

Manual data storage 4 von 200

15.02.2014 11:24:16
 pH 7.000 24.8 °C AR +++
 O2 7.80 mg/l 24.8 °C AR +++

ID number: 1

Continue

Back 15.02.2014
14:15

2. If necessary, change and confirm the ID number (1 ... 10000) with **<▲><▼>** and **<ENTER>**.
The dataset is stored. The meter switches to the measured value display.

If the memory is full The following window appears if all 200 storage locations are occupied:

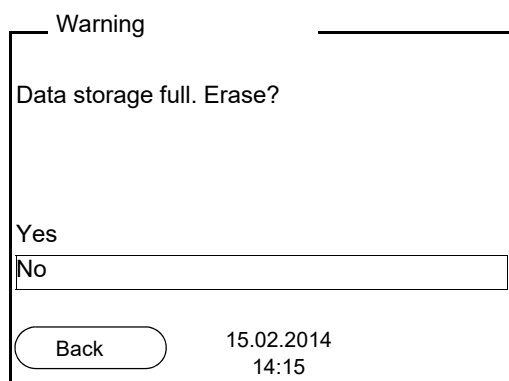

You have the following options:

- To erase the entire memory, confirm *Yes*.
- To cancel the storing process and switch to the measured value display, confirm *No*. Then you can e.g. store the recorded data to a PC (see section 11.3.1 EDITING THE MEASUREMENT DATA MEMORY, page 78) and subsequently erase the data memory (see section 11.3.2 ERASING THE MEASUREMENT DATA MEMORY, page 80).

11.2 Automatic data storage at intervals

The storing interval (*Interval*) determines the time interval between automatic data storing processes. With each data storage process, the current datasets of the sensors indicated on the display are transmitted to the interface at the same time.

Configuring the automatic memory function

1. Press the **<STO__>** key.
The menu for automatic data storing appears.

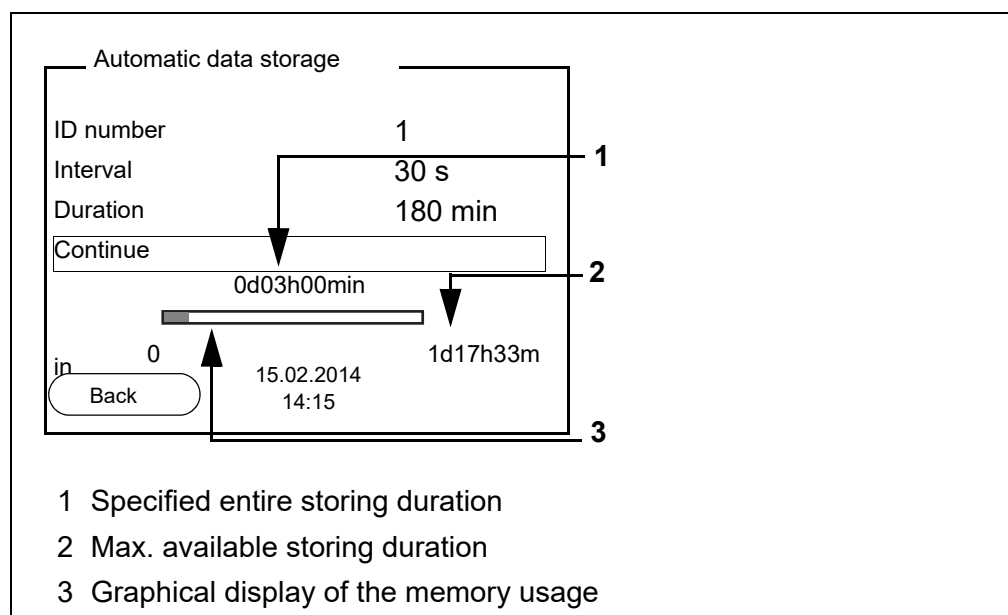

Settings You can configure the automatic data storing function with the following settings:

Menu item	Possible setting	Explanation
<i>ID number</i>	1 ... 10000	ID number for the dataset series.
<i>Interval</i>	1 s, 5 s, 10 s, 30 s, 1 min, 5 min, 10 min, 15 min, 30 min, 60 min	Storing interval. The lower limit of the storing interval can be restricted by the number of free memory locations. The upper limit is restricted by the storing duration.
<i>Duration</i>	1 min ... x min	Storing duration. Specifies after which time the automatic data storing should be terminated. The lower limit of the storing duration is restricted by the storing interval. The upper limit is restricted by the number of free memory locations.

Starting the automatic storing function

To start the automatic storing function, select *Continue* with **<▲>****<▼>** and confirm with **<ENTER>**. The meter switches to the measured value display.

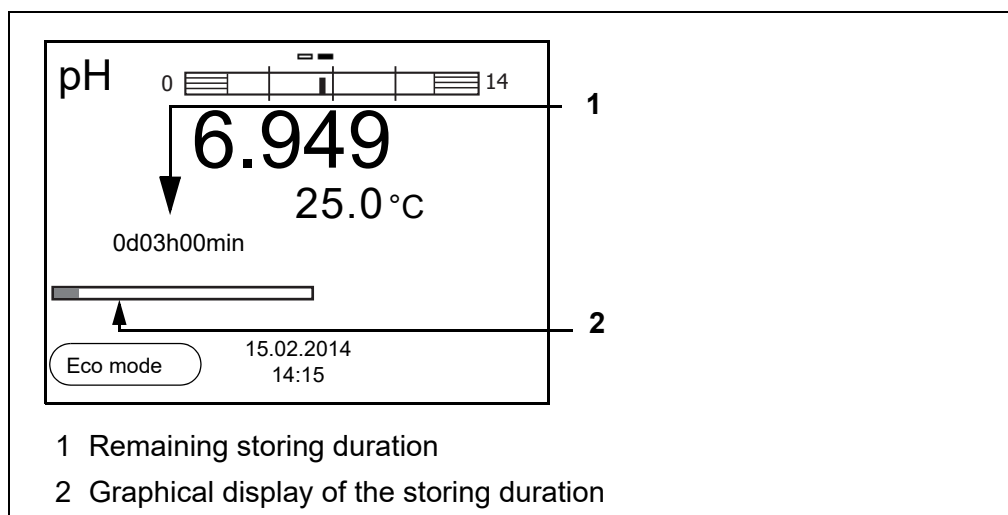

The active automatic storage function can be recognized by the progress bar in the function display. The progress bar indicates the remaining storage duration.



If the automatic storage function is activated, only the following keys are active: Softkeys, **<M>**, **<STO__>** and **<On/Off>**. The other keys and the automatic shut-off function are deactivated.

Energy saving mode ([Eco mode])

If the automatic storing function is active, the meter provides an energy saving mode ([Eco mode]) to avoid unnecessary energy consumption. The energy

saving mode switches off functions of the meter that are not required for the automatic storage of measurement data (such as the display). By pressing any key the energy saving mode is switched off again.

Terminating the automatic memory function prematurely

Proceed as follows to switch off the automatic data storing function before the adjusted storing duration has expired:

1. Press the **<STO__>** key.
The following window appears.

The image shows a rectangular dialog box with a thin border. At the top left, the word "Warning" is displayed. Below it, the text "Stop automatic storage?" is centered. Underneath, there are two options: "Yes" and "No". The "No" option is currently selected, indicated by a horizontal line extending from the text to the right edge of the box. At the bottom left, there is a rounded rectangular button labeled "Back". At the bottom right, the date and time "15.02.2014 14:15" are displayed.

2. Using **<▲><▼>**, select Yes and confirm with **<ENTER>**.
The meter switches to the measured value display.
The automatic data storing function is terminated.

11.3 Measurement data memory

11.3.1 Editing the measurement data memory

The contents of the manual or automatic measurement data memory can be shown on the display and output to the interface.

Each of the measurement data memories has a function to erase the entire contents.

Editing the data memory

The memory is edited in the menu, *Storage & config/ Data storage*. To open the *Storage & config* menu, press the **<ENTER__>** key in the measured value display.

Open the manual or automatic storage directly with the **<RCL>** or **<RCL__>** key.



The settings are explained here using the manual data memory as an example. The same settings and functions are available for the automatic data memory.

Settings

Menu item	Setting/ function	Explanation
<i>Data storage / Manual data storage / Display</i>	-	Displays all measurement datasets page by page. Further options: <ul style="list-style-type: none"> ● Scroll through the datasets with <▲><▼>. ● Output the displayed dataset to the interface with <F2>/[USB output]. ● Quit the display with <F1>/[Back].
<i>Data storage / Manual data storage / Erase</i>	-	Erases the entire manual measurement data memory. All calibration data remain stored when this action is performed.
<i>Data storage / Manual data storage / Output to USB</i>	-	Outputs all stored measurement data to the interface.

Display presentation of a dataset

Manual data storage	3 of 64	◆
15.02.2014 11:24:16 ID number: 2		
pH 7.000 24.8 °C AR +++		
O2 7.80 mg/l 24.8 °C AR +++		
Back	15.02.2014	
	14:15	

Representation of a dataset (USB output)

15.02.2014 09:56:20	
Multi 3320	
Ser. no. 08502113	
ID number 2	
pH1 6.012 24.8 °C, AR, S: +++	
O2 7.80 24.8 °C, AR, S: +++	

15.02.2014 10:56:20	
Multi 3320	
Ser. no. 08502113	
ID number 2	
pH1 6.012 24.8 °C, AR, S: +++	
O2 7.80 24.8 °C, AR, S: +++	

Quitting the display

To quit the display of stored measurement datasets, you have the following

options:

- Switch directly to the measured value display with **<M>**.
- Quit the display and move to the next higher menu level with **<F1>/[Back]**.

11.3.2 Erasing the measurement data memory

Erasing the measurement data memory (see section 11.3.1 EDITING THE MEASUREMENT DATA MEMORY, page 78).

11.3.3 Measurement dataset

A complete dataset consists of:

- ID number
- Date/time
- Measured values of the connected sensors
- Measured temperature value of the connected sensors or manually set temperature
- AutoRead info: The *AR* indicator appears with the measured value if the AutoRead criterion was met while storing (stable measured value). Otherwise, there is no *AR* indicator.
- Calibration evaluation: +++, ++, +, -, or no evaluation

11.3.4 Memory locations

The Multi 3320 meter has two measurement data memories. The measured values recorded either manually or automatic are stored separately in individual measurement data memories.

Data memory	Maximum number of datasets
<i>Manual data storage</i>	200
<i>Automatic data storage</i>	5000

12 Transmitting data (USB interface)

12.1 Options for data transmission

Via the USB interface you can transmit data to a PC. The following table shows which data are transmitted to the interface in which way:

Data	Control	Operation / description
Current data-sets of the sensors indicated on the display	Manual	<ul style="list-style-type: none"> ● With <F2>/[USB output]. ● Simultaneously with every manual data storage process (see section 11.1 MANUAL STORAGE, page 75).
	Automatic, at intervals	<ul style="list-style-type: none"> ● With <F2__>/[USB output]. Then you can set the transmission interval. ● Simultaneously with every automatic data storing process (see section 11.2 AUTOMATIC DATA STORAGE AT INTERVALS, page 76).
Stored measured values	Manual	<ul style="list-style-type: none"> ● Displayed dataset with <F2>/[USB output] after calling up from the memory. ● All datasets with the <i>Output to USB</i> function. (see section 11.3.1 EDITING THE MEASUREMENT DATA MEMORY, page 78).
Calibration records	Manual	<ul style="list-style-type: none"> ● Calibration record with <F2>/[USB output] (see section 5.2.6 CALIBRATION DATA, page 32).
	Automatic	<ul style="list-style-type: none"> ● At the end of a calibration procedure.



The following rule applies: With the exception of the menus, shortly pressing the **<F2>**/[USB output] key generally outputs the display contents to the interface (displayed measured values, measurement datasets, calibration records).

12.2 Connecting a PC

Connect the Multi 3320 to the PC via the USB interface.

NOTE

When connecting an grounded PC/printer, measurements cannot be performed in grounded media as the values would be incorrect. The USB interface is not galvanically isolated.

Installation of the USB driver on the PC

System requirements of the PC for installation of the USB driver:

1. Insert the supplied installation CD in the CD drive of your PC.
2. Install the driver from the CD.
Follow the Windows installation instructions as necessary.
3. Connect the Multi 3320 to the PC via the USB interface.
The meter is listed as a virtual COM interface among the connections in the Windows instrument manager.

12.3 MultiLab Importer

With the aid of the MultiLab Importer software, you can record and evaluate measurement data with a PC.



More detailed information can be found in the MultiLab Importer operating manual.

13 Maintenance, cleaning, disposal

13.1 Maintenance

13.1.1 General maintenance activities

The only maintenance activity required is replacing the batteries.



See the relevant operating manuals of the electrodes for instructions on maintenance.

13.1.2 Replacing the batteries

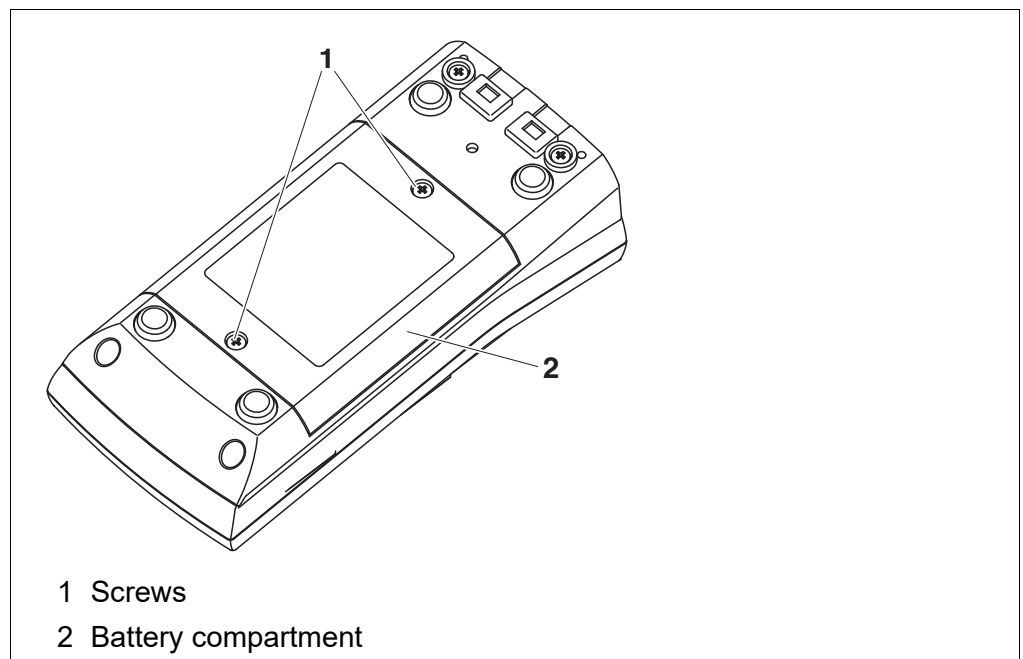

1. Unscrew the two screws (1) on the underside of the meter.
2. Open the battery compartment (2) on the underside of the meter.
3. Remove the batteries from the battery compartment.



CAUTION

**Make sure that the poles of the batteries are positioned correctly.
The \pm signs on the batteries must correspond to the \pm signs in the battery compartment.**



You can operate the meter either with normal batteries or with rechargeable batteries (Ni-MH). In order to charge the batteries, an external charging device is required.

4. Place four batteries (type Mignon AA) in the battery compartment.
5. Close the battery compartment.
6. Set the date and time
(see section 4.4.6 EXAMPLE 2 ON NAVIGATION: SETTING THE DATE AND TIME, page 20).



When the batteries are nearly discharged, the  status indicator is displayed.



Dispose of used batteries according to the local regulations of your country.

End users within the European Union are obligated to return used batteries (even ecologically compatible ones) to a collection point set up for recycling purposes.

Batteries are marked with the crossed-out waste container symbol. Therefore, they may not be disposed with the domestic waste.

13.2 Cleaning

Occasionally wipe the outside of the measuring instrument with a damp, lint-free cloth. Disinfect the housing with isopropanol as required.



CAUTION

The housing is made of synthetic material (ABS). Thus, avoid contact with acetone or similar detergents that contain solvents. Remove any splashes immediately.

13.3 Packing

This meter is sent out in a protective transport packing. We recommend: Keep the packing material. The original packing protects the meter against damage during transport.

13.4 Disposal

At the end of its operational lifetime, the meter must be returned to the disposal or return system statutory in your country. If you have any questions, please contact your supplier.

13.4.1

	Order no. (Catalogue No.)	
	EU	NA
Measuring cells		
pHenomenal CO 11 CONDUCTIVITY SENSOR PHENOMENAL 1,5M 8PIN	663-0147	76470-822
Solutions	EU	NA
KCl 0.01 mol/L: 1.413 mS/cm, 100 mL	83607.180	-
KCl 0.01 mol/L: 1.413 mS/cm, 500 mL	83607.290	89236-544
KCl 0.1 mol/L: 12.8 mS/cm, 500 mL	83608.260	89236-546

13.4.2

	Order no. (Catalogue No.)	
	EU	NA
Measuring cells		
pHenomenal OXY 11 OXYGEN SENSOR PHENOMENAL 3M 8 PIN	664-0042	76470-820
Accessories	EU	NA
MAINTENANCE KIT OXYGEN	664-0049	76460-466

14 What to do if...

14.1 pH/ORP



More information and instructions on cleaning and exchange of sensors are given in the documentation of your sensor.

Error message
OFL, UFL

The measured value is outside the measuring range.

Cause	Remedy
Electrode:	
– Air bubble in front of the junction	– Remove air bubble
– Air in the junction	– Extract air or moisten junction
– Cable broken	– Replace the electrode
– Gel electrolyte dried out	– Replace the electrode
– The measured value is outside the measuring range of the meter	– Use a suitable electrode

Error message,
Error

Cause	Remedy
Electrode:	
– The values determined for zero point and slope of the electrode are outside the allowed limits.	– Recalibrate
– Junction contaminated	– Clean the junction
– Electrode broken	– Replace the electrode
Buffer solutions:	
– Incorrect buffer solutions	– Change calibration procedure
– Buffer solutions too old	– Use only once. Note the shelf life
– Buffer solutions depleted	– Change solutions

No stable measured value	Cause	Remedy
	Electrode:	
	– Junction contaminated	– Clean the junction
	– Membrane contaminated	– Clean membrane
	Test sample:	
	– pH value not stable	– Measure with air excluded if necessary
	– Temperature not stable	– Temper if necessary
	Electrode + test sample:	
	– Conductivity too low	– Use a suitable electrode
	– Temperature too high	– Use a suitable electrode
– Organic liquids	– Use a suitable electrode	
Obviously incorrect measured values	Cause	Remedy
	Electrode:	
	– Electrode unsuitable	– Use a suitable electrode
	– Temperature difference between buffer and test sample too great	– Adjust temperature of buffer or sample solutions
– Measurement procedure not suitable	– Follow special procedure	

14.2 ISE

Error message <i>OFL</i>	Cause	Remedy
	– Measuring range exceeded	– Dilute test sample
Obviously incorrect measured values	Cause	Remedy
	– Electrode not connected	– Connect the electrode
	– Cable broken	– Replace the electrode
Error message <i>Error</i> (invalid calibration)	Cause	Remedy
	<i>ISE electrode:</i>	
	– Moisture in the plug	– Dry plug
	– Electrode obsolete	– Replace the electrode
	– Electrode unsuitable for the range to be measured	– Use a suitable electrode
	– Electrode not suitable for the selected ion	– Use a suitable electrode or select a suitable ion
	– The gas-sensitive electrode NH 500 was calibrated with the <i>Ion type NH4</i> setting	– Select the following settings: <i>Ion type</i> = ION, <i>Valency</i> = -1
	– Socket damp	– Dry socket
	<i>Calibration procedure:</i>	
	– Calibration standards do not have the correct temperature (max. ± 2 °C temperature difference)	– Adjust the temperature of the calibration standards
Warning [<i>TpErr</i>]	Cause	Remedy
	– Temperature difference between measurement and calibration greater than 2 K.	– Adjust the temperature of the test sample
Warning [<i>ISEErr</i>]	Cause	Remedy
	– Electrode voltage outside calibrated range	– Recalibrate

14.3 Dissolved oxygen



More information and instructions on cleaning and exchange of sensors are given in the documentation of your sensor.

Error message
OFL, UFL

The measured value is outside the measuring range.

Cause

- The measured value is outside the measuring range of the meter

Remedy

- Use a suitable D.O. sensor

Error message,
Error

Cause

- D.O. sensor contaminated
- Electrolyte depleted

Remedy

- Clean the D.O. sensor
- Change the electrolyte and membrane cap
- If necessary, replace the D.O. sensor

Error message
Leak

Cause

- Membrane cap not screwed on tight enough
- Hole in the membrane

Remedy

- Screw membrane head tighter
- Replace and refill the membrane cap

14.4 Conductivity



More information and instructions on cleaning and exchange of sensors are given in the documentation of your sensor.

Error message *OFL, UFL*

The measured value is outside the measuring range.

Cause	Remedy
<ul style="list-style-type: none"> – The measured value is outside the measuring range of the meter 	<ul style="list-style-type: none"> – Use a suitable measuring cell

Error message, *Error*

Cause	Remedy
<ul style="list-style-type: none"> – Measuring cell contaminated 	<ul style="list-style-type: none"> – Clean cell and replace it if necessary
<ul style="list-style-type: none"> – Calibration solution not suitable 	<ul style="list-style-type: none"> – Check the calibration solutions

14.5 General information

Sensor symbol flashes	Cause <ul style="list-style-type: none"> – Calibration interval expired 	Remedy <ul style="list-style-type: none"> – Recalibrate the measuring system
Display 	Cause <ul style="list-style-type: none"> – Batteries almost empty 	Remedy <ul style="list-style-type: none"> – Replace the batteries (see section 13.1 MAINTENANCE, page 83)
Meter does not react to keystroke	Cause <ul style="list-style-type: none"> – Operating condition undefined or EMC load unallowed 	Remedy <ul style="list-style-type: none"> – Processor reset: Press the <ENTER> and <On/Off> key simultaneously
You want to know which software version is in the meter	Cause <ul style="list-style-type: none"> – E.g., a question by the service department 	Remedy <ul style="list-style-type: none"> – Switch on the meter. Open the menu, <ENTER__ > / <i>Storage & config / System / Service information</i>. The instrument data are displayed.

15 Technical data

15.1 Measuring ranges, resolution, accuracy

15.1.1 pH/ORP

Measuring ranges, resolution

Variable	Measuring range	Resolution
pH	-2.0 ... +20.0	0.1
	-2.00 ... +20.00	0.01
	- 2.000 ... + 19.999	0.001
U [mV]	-2500 ... +2500	1
	-1200.0 ... +1200.	0.1
T [°C]	-5.0 ... +105.0	0.1
T [°F]	23.0 ... +221.0	0.1

Manual temperature input

Variable	Range	Increment
T _{manual} [°C]	-25 ... +130	1
T _{manual} [°F]	-13 ... +266	1

Accuracy (± 1 digit)

Variable	Accuracy	Temperature of the test sample
pH / range *		
-2.0 ... +20.0	± 0.1	+15 °C ... +35 °C
-2.00 ... +20.00	± 0.01	+15 °C ... +35 °C
- 2.000 ... + 19.999	± 0.005	+15 °C ... +35 °C
U [mV] / range		
-2500 ... +2500	± 1	+15 °C ... +35 °C
-1200.0 ... +1200.	± 0.3	+15 °C ... +35 °C
T [°C] / temperature sensor		
NTC 30	± 0.1	
PT 1000	± 0.1	

* when measuring in a range of ± 2 pH around a calibration point



The accuracy values specified here apply exclusively to the meter. The accuracy of the electrodes and buffer solutions has to be taken into account additionally.

15.1.2 ISE

Measuring ranges,
resolution

Variable	Measuring range	Resolution
ISE [mg/l]	0.000 ... 9.999	0,001
	10.00 ... 99.99	0,01
	100.0 ... 999.9	0.1
	1000 ... 999999	1
ISE [μ mol/l]	0.000 ... 9.999	0,001
	10.00 ... 99.99	0,01
	100.0 ... 999.9	0.1
	1000 ... 999999	1
[mmol/l]	1000 ... 999999	1
ISE [mg/kg]	0.000 ... 9.999	0,001
	10.00 ... 99.99	0,01
	100.0 ... 999.9	0.1
	1000 ... 999999	1
ISE [ppm]	0.000 ... 9.999	0,001
	10.00 ... 99.99	0,01
	100.0 ... 999.9	0.1
	1000 ... 999999	1
ISE [%]	0.000 ... 9.999	0,001
	10.00 ... 99.99	0,01
	100.0 ... 999.9	0.1
	1000 ... 999999	1

Manual
temperature input

Variable	Range	Increment
T _{manual} [°C]	- 20 ... + 130	1

15.1.3 Oxi

Measuring ranges,
resolution
(depending on the
sensor)

Variable	Measuring range	Resolution
Concentration [mg/l]	0 ... 20.00 (0 ... 20.0)	0.01 (0.1)
	20.0 ... 90.0	0.1 (1)
	(20 ... 90)	
Saturation [%]	0 ... 200.0 (0 ... 600)	0.1 (1)
	0 ... 600	1
D.O. partial pressure [mbar]	0 ... 200.0 (0 ... 1250)	0.1 (1)
	0 ... 1250	1
T [°C]	0 ... 50,0	0.1

Accuracy (± 1 digit)

Variable	Accuracy
Concentration [mg/l]	± 0.5 % of measured value at ambient temperature of $+5$ °C ... $+30$ °C
Saturation [%]	± 0.5 % of measured value when measuring in the range of ± 10 K around the calibration temperature
D.O. partial pressure [mbar]	± 0.5 % of measured value at ambient temperature of $+5$ °C ... $+30$ °C
T [°C] / temperature sensor	
NTC 30	± 0.1
PT 1000	± 0.1

Correction functions

Temperature compensation	Accuracy better than 2 % at 0 ... $+40$ °C
Salinity correction	0 ... 70.0 SAL
Air pressure correction	Automatic through integrated pressure sensor in the range of 500 ... 1100 mbar



The accuracy values specified here apply exclusively to the meter. The accuracy of the D.O. sensors has also to be taken into account.

15.1.4 Cond

Measuring ranges,
resolution
(depending on the sensor)

Variable	Measuring range	Resolution
χ [μ S/cm]	0.000 ... 1.999*	0.001
	0.00 ... 19.99**	0.01
	0.0 ... 199.9	0.1
	200 ... 1999	1
χ [mS/cm]	2.00 ... 19.99	0.01
	20.0 ... 199.9	0.1
	200 ... 1000	1
ρ (Resistivity) [Ohm*cm]	1.000 ... 1.999	0.001
	2.00 ... 19.99	0.01
	20.0 ... 199.9	0.1
	200 ... 1999	1
ρ (Resistivity) [kOhm*cm]	2.00 ... 19.99	0.01
	20.0 ... 199.9	0.1
	200 ... 1999	1
ρ (Resistivity) [MOhm*cm]	2.00 ... 19.99**	0.01
	20.0 ... 199.9*	0.1
SAL	0.0 ... 70.0 according to the IOT table	0.1
TDS	0 ... 1999 mg/l	1
	2.00 ... 19.99 g/l	0.01
	20.0 ... 199.9 g/l	0.1
T [°C]	-5.0 ... +105.0	0.1
T [°F]	+23.0 ... +221.0	0.1

* only possible with cells of the cell constant, 0.010 cm⁻¹

** only possible with cells of the cell constant, 0.010 cm⁻¹ or 0.090 ... 0.110 cm⁻¹

Cell constants

Cell constant C	Values
Can be calibrated in the ranges	0.450 ... 0.500 cm ⁻¹ 0.800 ... 0.880 cm ⁻¹
Adjustable	0.090 ... 0.110 cm ⁻¹ 0.010 cm ⁻¹ (fixed)

Reference temperature

Reference temperature	Values
Adjustable	20 °C (Tref20) 25 °C (Tref25)

Accuracy (± 1 digit)

Variable	Accuracy	Temperature of the test sample
χ and ρ / temperature compensation		
None (Off)	$\pm 0.5 \%$	
Nonlinear (nLF)	$\pm 0.5 \%$	0 °C ... +35 °C according to EN 27 888
	$\pm 0.5 \%$	+35 °C ... +50 °C enhanced nLF function
Linear (lin)	$\pm 0.5 \%$	+10 °C ... +75 °C
SAL / range		
0.0 ... 42.0	± 0.1	+5 °C ... +25 °C
	± 0.2	+25 °C ... +30 °C
TDS [mg/l]		
	$\pm 0.5 \%$	
T [°C] / temperature sensor		
NTC 30	± 0.1	
PT 1000	± 0.1	



The accuracy values specified here apply exclusively to the meter. The accuracy of the measuring cell has also to be taken into account.



Further data are given in the documentation of your sensor.

15.2 General data

Dimensions

ca. 180 x 80 x 55 mm

Weight

Approx. 0.4 kg

Mechanical structure

Type of protection IP 67

Electrical safety

Protective class III

Test certificates

CE

Ambient conditions

Storage -25 °C ... +65 °C

Operation -10 °C ... +55 °C

Admissible relative humidity
Yearly mean: < 75 %
30 days/year: 95 %
Other days: 85 %

Power supply

Batteries	4 x 1.5 V alkali-manganese batteries, type AA
Rechargeable batteries	4 x 1.2 V NiMH rechargeable batteries, type AA (no charging function)
Operational life	Up to 1000 h without / 150 h with illumination

pH sensor input

Input resistance	$> 5 * 10^{12}$ ohm
Input current	$< 1 * 10^{-12}$ A

USB interface

Type	USB 1.1 USB B (device), data output
Baud rate	Adjustable: 1200, 2400, 4800, 9600, 19200 Baud
Data bits	8
Stop bits	2
Parity	None
Handshake	RTS/CTS
Cable length	Max. 3 m

Guidelines and norms used

EMC	EU directive 2014/30/EU EN 61326-1 FCC Class A
Meter safety	EU directive 2014/35/EU EN 61010-1
IP protection class	EN 60529
RoHS	EU directive 2011/65/EU

16 Firmware update

Available firmware updates are provided on the Internet.

With the firmware update program and a PC you can update the firmware of the Multi 3320 to the newest version.

For the update you have to connect the meter to a PC.

For the update via the USB interface, the following is required:

- a free USB interface (virtual COM port) on the PC
- the driver for the USB interface (on the enclosed CD-ROM)
- the USB cable (included in the scope of delivery of the Multi 3320).

1. Install the downloaded firmware update on a PC.
An update folder is created in the Windows start menu.
If an update folder already exists for the meter (or meter type), the new data is displayed there.
2. In the windows start menu, open the update folder and start the firmware update program.
3. Using the USB interface cable, connect the Multi 3320 to a USB interface (virtual COM port) of the PC.
4. Switch on the Multi 3320.
5. In the firmware update program, start the update process with OK.
6. Follow the instructions of the firmware update program.
During the programming process, a corresponding message and a progress bar (in %) are displayed.
The programming process takes approx. three minutes. A terminatory message is displayed after a successful programming process. The firmware update is completed.
7. Disconnect the Multi 3320 from the PC.
The Multi 3320 is ready for operation again.

After switching the meter off and on you can check whether the meter has taken over the new software version (see YOU WANT TO KNOW WHICH SOFTWARE VERSION IS IN THE METER, PAGE 91).

17 Glossary

pH/ORP/ISE

Asymmetry	see zero point
Electromotive force of an electrode	The electromotive force U of the electrode is the measurable electromotive force of an electrode in a solution. It equals the sum of all the galvanic voltages of the electrode. Its dependency on the pH results in the electrode function, which is characterized by the parameters, slope and zero point.
Junction	The junction is a porous body in the housing wall of reference electrodes or electrolyte bridges. It arranges the electrical contact between two solutions and makes the electrolyte exchange more difficult. The expression, junction, is also used for ground or junction-less transitions.
ORP	The ORP is caused by oxidizing or reducing substances dissolved in water if these substances become effective on an electrode surface (e.g. a gold or platinum surface).
pH value	The pH value is a measure of the acidic or basic effect of an aqueous solution. It corresponds to the negative decadic logarithm of the molal hydrogen ions activity divided by the unit of the molality. The practical pH value is the value of a pH measurement.
Potentiometry	Name of a measuring technique. The signal (depending on the measured parameter) of the electrode is the electrical potential. The electrical current remains constant.
Slope	The slope of a linear calibration function.
Zero point	The zero point of a pH electrode is the pH value at which the electromotive force of the pH electrode at a specified temperature is zero. Normally, this is at 25 °C.

Dissolved oxygen

D.O. partial pressure	Pressure caused by the oxygen in a gas mixture or liquid.
D.O. saturation	Short name for the relative D.O. saturation.
OxiCal®	Name for a procedure to calibrate D.O. measuring systems in water vapor-saturated air.
Salinity	The absolute salinity S_A of seawater corresponds to the relationship of the mass of dissolved salts to the mass of the solution (in g/Kg). In practice, this dimension cannot be measured directly. Therefore, the practical salinity according to IOT is used for oceanographic monitoring. It is determined by measuring the electrical conductivity.
Salt content	General designation for the quantity of salt dissolved in water.
Slope (relative)	The relative slope expresses the relation of the slope value to the value of a theoretical reference sensor of the same construction type.

Conductivity

Cell constant C	Characteristic quantity of a conductivity measuring cell, depending on the geometry.
Conductivity	Short form of the expression, specific electrical conductivity. It corresponds to the reciprocal value of the resistivity. It is a measured value of the ability of a substance to conduct an electric current. In water analysis, the electrical conductivity is a dimension for the ionized substances in a solution.
Reference temperature	Fixed temperature value to compare temperature-dependent measured values. For conductivity measurements, the measured value is converted to a conductivity value at a reference temperature of 20 °C or 25 °C.
Resistance	Short name for the specific electrolytic resistance. It corresponds to the reciprocal value of the electrical conductivity.
Salinity	The absolute salinity S_A of seawater corresponds to the relationship of the mass of dissolved salts to the mass of the solution (in g/Kg). In practice, this dimension cannot be measured directly. Therefore, the practical salinity according to IOT is used for oceanographic monitoring. It is determined by measuring the electrical conductivity.
Salt content	General designation for the quantity of salt dissolved in water.
Temperature coefficient	Value of the slope α of a linear temperature function. $\mathcal{R}_{T_{\text{Ref}}} = \mathcal{R}_{\text{Meas}} * \frac{1}{1 + \alpha * (T - T_{\text{Ref}})}$
Temperature compensation	Name of a function that considers the temperature influence on the measurement and converts it accordingly. Depending on the measured parameter to be determined, the temperature compensation functions in different ways. For conductimetric measurements, the measured value is converted to a defined reference temperature. For potentiometric measurements, the slope value is adjusted to the temperature of the test sample but the measured value is not converted.

General topics

Adjusting	To manipulate a measuring system so that the relevant value (e.g. the displayed value) differs as little as possible from the correct value or a value that is regarded as correct, or that the difference remains within the tolerance.
AutoRange	Name of the automatic selection of the measuring range.
Calibration	Comparing the value from a measuring system (e.g. the displayed value) to the correct value or a value that is regarded as correct. Often, this expression is also used when the measuring system is adjusted at the same time (see adjusting).

Channel	A channel is a display indication that corresponds to a physical connection on the meter.
Measured parameter	The measured parameter is the physical dimension determined by measuring, e.g. pH, conductivity or D.O. concentration.
Measured value	The measured value is the special value of a measured parameter to be determined. It is given as a combination of the numerical value and unit (e.g. 3 m; 0.5 s; 5.2 A; 373.15 K).
Molality	Molality is the quantity (in Mol) of a dissolved substance in 1000 g solvent.
Reset	Restoring the original condition of all settings of a measuring system.
Resolution	Smallest difference between two measured values that can be displayed by a meter.
Stability control (AutoRead)	Function to control the measured value stability.
Standard solution	The standard solution is a solution where the measured value is known by definition. It is used to calibrate a measuring system.
Temperature function	Name of a mathematical function expressing the temperature behavior of a test sample, a sensor or part of a sensor.
Test sample	Designation of the test sample ready to be measured. Normally, a test sample is made by processing the original sample. The test sample and original sample are identical if the test sample was not processed.

18 Index

A

Air calibration beaker	47
Automatic switch-off function	16
AutoRead	
ORP	36, 38, 46, 53
pH	23

B

Battery compartment	12, 83
---------------------------	--------

C

Calibration	
ISE	40
pH	25, 37
Calibration evaluation	50, 56
ISE	44
pH	33
Calibration interval	61, 65, 68
Calibration points	
pH	31
Comparison measurement (D.O.)	47
Connecting a PC	82
Connectors	15
Control standard	54
Copyright	2

D

Dataset	80
Date and time	20
Default settings	
Measured parameter	72, 73
System settings	74
Display	14

E

Energy saving mode	77
--------------------------	----

F

Firmware update	98
-----------------------	----

I

Initial commissioning	11
Initialize	72
Interval for calibration	61, 65, 68

K

Keys	13
------------	----

M

Measured value display	17
Measurement accuracy	61, 65, 68
Measurement data memory	
Edit	78
Erase	78
Measurement dataset	80
Measuring	45, 52
ISE	38
ORP	36
pH	23
Menus (navigation)	17
Messages	18

P

pH buffer sets	58
Print	81

R

Reset	72
-------------	----

S

Scope of delivery	11
Single-point calibration	
pH	26, 30
Slope	
ISE	40
pH	25
Slope, relative	47
Stability control	
Automatic	71
Storing in memory	75
Automatic	76
Manual	75
Storing interval	76

T

TDS factor	69
Temperature compensation	68
Temperature measurement	46
ISE	39
pH	24, 37
Three-point calibration	
ISE	43
pH	27, 31
Transmitting data	81
Automatic	81
Manual	81
Transmitting measured values	81

Two-point calibration

ISE 42
pH 26, 30

Z

Zero point of pH electrode 25

Xylem |'zīləm|

- 1) The tissue in plants that brings water upward from the roots;
- 2) a leading global water technology company.

We're a global team unified in a common purpose: creating advanced technology solutions to the world's water challenges. Developing new technologies that will improve the way water is used, conserved, and re-used in the future is central to our work. Our products and services move, treat, analyze, monitor and return water to the environment, in public utility, industrial, residential and commercial building services settings. Xylem also provides a leading portfolio of smart metering, network technologies and advanced analytics solutions for water, electric and gas utilities. In more than 150 countries, we have strong, long-standing relationships with customers who know us for our powerful combination of leading product brands and applications expertise with a strong focus on developing comprehensive, sustainable solutions.

For more information on how Xylem can help you, go to www.xylem.com.



Service and Returns:

Xylem Analytics Germany
Sales GmbH & Co. KG
WTW
Am Achalaich 11
82362 Weilheim
Germany

Tel.: +49 881 183-325

Fax: +49 881 183-414

E-Mail wtw.rma@xylem.com

Internet: www.xylemanalytics.com



Xylem Analytics Germany GmbH
Am Achalaich 11
82362 Weilheim
Germany

