

FDO[®] 70x IQ F

DIQ/S 181 - OPTICAL D.O. SENSORS



a xylem brand

FDO® 70x IQ F - Contents

1	Overview	5
1.1	Models	5
1.2	Recommended fields of application	5
1.3	Structure	6
2	Safety	7
2.1	Safety information	7
2.1.1	Safety information in the operating manual	7
2.1.2	Safety signs on the product	7
2.1.3	Further documents providing safety information	7
2.2	Safe operation	8
2.2.1	Authorized use	8
2.2.2	Requirements for safe operation	8
2.2.3	Unauthorized use	8
3	Commissioning	9
3.1	Scope of delivery	9
3.2	Installation	9
3.3	Commissioning / Getting the sensor ready for measurement	9
3.4	Setting table for the FDO® 70x IQ F	10
4	Measurement / operation	13
4.1	Measuring	13
4.2	Function check and user calibration	13
4.2.1	General information	13
4.2.2	Function check	14
4.2.3	User calibration	15
4.2.4	Reactivating a valid calibration	17
5	Maintenance, cleaning, replacement parts	18
5.1	General maintenance notes	18
5.2	Handling of the sensor cap	18
5.3	Exchanging the sensor cap	18
5.4	Cleaning the sensor	19
5.4.1	Exterior cleaning	19
5.4.2	Interior cleaning of sensor cap and sensor head	20
5.5	Replacement parts and accessories	20
5.6	Disposal	21

6	What to do if...	22
7	Technical data	24
7.1	General measurement characteristics	24
7.2	Application conditions	24
7.3	General data	25
7.4	Electrical data	25
7.5	Technical data of the SC-FDO® 700	26
7.6	Technical data of the SC-FDO® 701	27
8	Indexes	28
8.1	Explanation of the messages	28
8.1.1	Error messages	28
8.1.2	Informative messages	30

1 Overview

1.1 Models

The FDO® 70x IQ F consists of a sensor basis equipped with different sensor cap types, depending on the model:

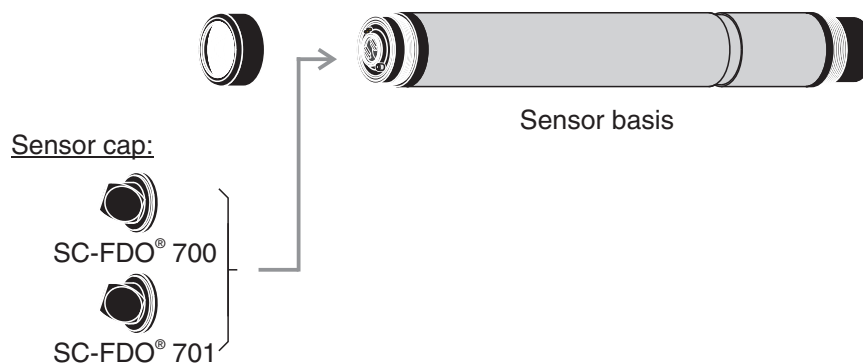

Variants

Sensor model	Sensor basis *	Sensor cap
FDO® 700 IQ F	FDO® 700 IQ F	SC-FDO® 700
FDO® 701 IQ F	FDO® 700 IQ F	SC-FDO® 701

* Designation on the name plate in the plug head connector

The sensor cap primarily determines the measuring characteristics of the sensor as a whole. Thus the sensor can be adapted to the measuring job by exchanging the type of sensor cap. The specifications of the individual sensor cap types are given in chapter 7 TECHNICAL DATA.

1.2 Recommended fields of application

Sensor model	Recommended field of application.
FDO® 700 IQ F FDO® 701 IQ F	Stationary measurements in water/wastewater applications.

1.3 Structure

Structure

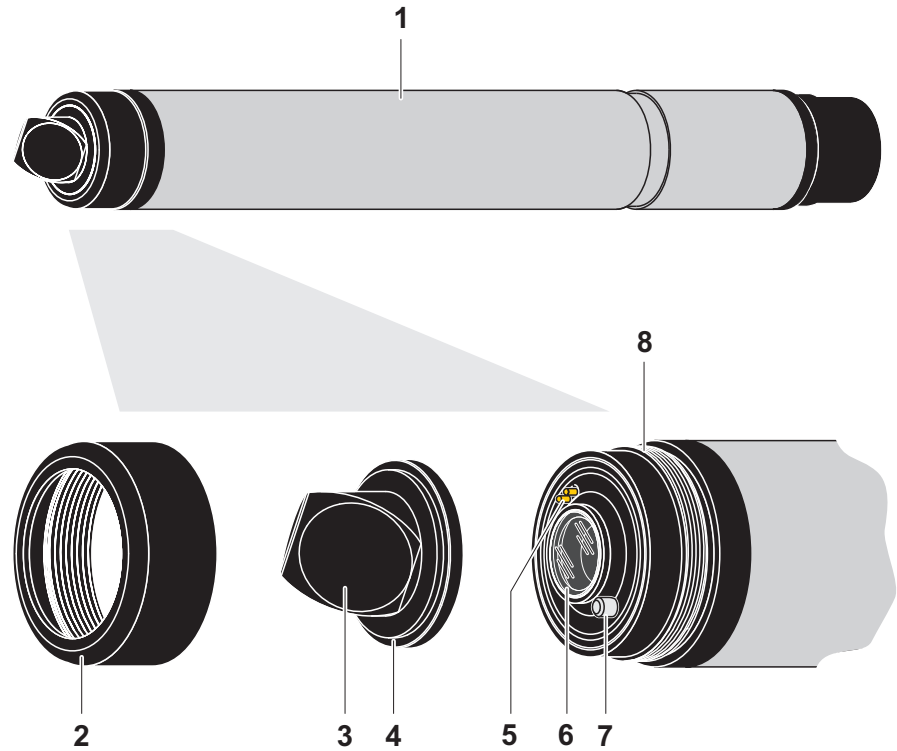

Fig. 1-1 Structure of the D.O. sensor

1	Shaft
2	Fixing ring
3	Sensor membrane
4	Sensor cap with memory chip
5	Gold-plated contact pins for memory chip
6	Measurement window
7	Temperature sensor and locking device
8	Sensor head

Sensor cap with memory chip

A memory chip is integrated in the sensor cap. The following data are stored on the memory chip:

- Type designation of the sensor cap
- Series number
- Data of the factory calibration

Intelligent membrane (IQMC technology)

For each membrane, the individual calibration values are determined by a factory calibration process and stored to the memory chip of the sensor cap, ensuring maximum accuracy over the whole lifetime of the sensor.

2 Safety

2.1 Safety information

2.1.1 Safety information in the operating manual

This operating manual provides important information on the safe operation of the product. Read this operating manual thoroughly and make yourself familiar with the product before putting it into operation or working with it. The operating manual must be kept in the vicinity of the product so you can always find the information you need.

Important safety instructions are highlighted in this operating manual. They are indicated by the warning symbol (triangle) in the left column. The signal word (e.g. "CAUTION") indicates the level of danger:



WARNING

indicates a possibly dangerous situation that can lead to serious (irreversible) injury or death if the safety instruction is not followed.



CAUTION

indicates a possibly dangerous situation that can lead to slight (reversible) injury if the safety instruction is not followed.

NOTE

indicates a situation where goods might be damaged if the actions mentioned are not taken.

2.1.2 Safety signs on the product

Note all labels, information signs and safety symbols on the product. A warning symbol (triangle) without text refers to safety information in this operating manual.

2.1.3 Further documents providing safety information

The following documents provide additional information, which you should observe for your safety when working with the measuring system:

- Operating manuals of other components of the measuring system (DIQ/S 181, accessories)
- Safety datasheets of calibration and maintenance equipment (e.g. cleaning solutions).

2.2 Safe operation

2.2.1 Authorized use

The authorized use of the FDO® 70x IQ F consists of its use as a sensor in the DIQ/S 181. Only the operation and running of the sensor according to the instructions and technical specifications given in this operating manual is authorized (see chapter 7 TECHNICAL DATA). Any other use is considered unauthorized.

2.2.2 Requirements for safe operation

Note the following points for safe operation:

- The product may only be operated according to the authorized use specified above.
- The product may only be supplied with power by the energy sources mentioned in this operating manual.
- The product may only be operated under the environmental conditions mentioned in this operating manual.
- The product may not be opened.

2.2.3 Unauthorized use

The product must not be put into operation if:

- it is visibly damaged (e.g. after being transported)
- it was stored under adverse conditions for a lengthy period of time (storing conditions, see chapter 7 TECHNICAL DATA).

3 Commissioning

3.1 Scope of delivery

- Sensor, consisting of sensor basis and sensor cap
- Operating manual.

3.2 Installation



How to connect the sensor cable to the terminal strip of the DIQ/S 181 is described in chapter 3 INSTALLATION of the DIQ/S 181 operating manual



Do not suspend the sensor on the sensor cable. Use a sensor holder or armature. Information on this and other DIQ/S 181 accessories is given in the WTW catalog and on the Internet.

3.3 Commissioning / Getting the sensor ready for measurement

Identification in the DIQ/S 181

Both the sensor cap and sensor basis (sensor without cap) have a series number of their own. The sensor has to be equipped with a sensor cap for a successful login to the DIQ/S 181 controller. The operable sensor is displayed as follows in the list of components:

- *Model:* Model designation of the sensor cap (= "SC FDO 70x")
- *Ser. no.:* Series number of the sensor cap
- *Sensor name:* The series number of the sensor basis is preset here. You can change this entry as necessary by entering a user-defined name.

Commissioning steps

1	Pull the protective cap off the sensor.
2	If required, assign a user-defined name to the sensor (see DIQ/S 181 operating manual).
3	Enter the average air pressure or the altitude of the installation site (for more detailed information, see DIQ/S 181 operating manual).
4	Set up the sensor (see section 3.4).

3.4 Setting table for the FDO® 70x IQ F

Carrying out settings

Using <S>, switch from the measured value display to the main menu of the settings. Then navigate to the setting menu (setting table) of the sensor. The procedure is described in detail in the DIQ/S 181 operating manual.

Setting	Selection/values	Explanation
<i>Measuring mode</i>	<ul style="list-style-type: none"> ● <i>Concentration</i> ● <i>Saturation</i> 	Unit of the measured value in the measured value display.
<i>Measuring range Concentration</i>	<ul style="list-style-type: none"> ● <i>0 ... 20.00 mg/l</i> ● <i>0 ... 20.00 ppm</i> 	These measuring ranges are available for selection.
<i>Measuring range Saturation</i>	<ul style="list-style-type: none"> ● <i>0 ... 200.0 %</i> 	The measuring range is permanently set.
<i>Response time t90</i>	<ul style="list-style-type: none"> ● <i>150 .. 300 s</i> (with SC-FDO® 700) or ● <i>60 ... 300 s</i> (with SC-FDO® 701) 	<p>Response time of the signal filter. Depending on the sample matrix, the measured values may fluctuate more or less. A signal filter in the sensor reduces the limits of variation of the measured value. The signal filter is characterized by the <i>Response time t90</i>. This is the time after which 90 % of a signal change is displayed.</p> <p>The setting range depends on the sensor cap type.</p>
<i>Calibration</i>	<ul style="list-style-type: none"> ● <i>Factory calibration</i> ● <i>User calibration</i> ● <i>active</i> ● <i>abort</i> 	<p>Determines which calibration data the measured value calculation will be based on. The active calibration is displayed in the calibration history.</p> <p>The selection <i>User calibration</i> is only displayed if valid data of a <i>User calibration</i> is stored in the sensor.</p> <p><i>active</i> indicates that the sensor is being calibrated.</p> <p>If <i>abort</i> is selected, the active calibration is canceled the next time the setting table is quit with <i>Save and quit</i>.</p>
<i>Test</i> (is displayed only during the sensor check, see section 4.2.2)	<ul style="list-style-type: none"> ● <i>active</i> ● <i>abort</i> 	<p><i>active</i> indicates that the sensor is being checked.</p> <p>If <i>abort</i> is selected, the active check is canceled the next time the setting table is quit with <i>Save and quit</i>.</p>

Setting	Selection/values	Explanation
<i>Temperature mode</i>	<ul style="list-style-type: none"> ● °C ● °F 	Unit of the measured temperature value (Celsius, Fahrenheit).
<i>Temp. adjustment</i>	-1.5 K ... +1.5 K	<p>The temperature compensation enables the temperature display to be balanced (shifting of the zero point by ± 1.5K).</p> <p>Notes:</p> <ul style="list-style-type: none"> ● Due to the thermal capacity of the sensor, it is necessary to place it in a container with at least 2 liters of water. ● Leave the sensor in this container for at least 15 minutes while stirring occasionally until the balancing can be performed. <p>With temperature differences between the water and sensor > 10 °C, leave the sensor for at least 1 hour in this container while stirring occasionally until the balancing can be performed.</p>
<i>Salinity</i>	<ul style="list-style-type: none"> ● On ● Off 	Determines whether the entered salinity should be taken into account.
<i>Salinity input</i> (only with <i>Salinity</i> = On)	2.0 ... 70.0	<p>The entry of the salinity enables a salt content correction that compensates for the effect of salt contents > 0.1 % on the oxygen measurement.</p> <p>The salt content correction is recommended for measurements in salt-contaminated wastewater (salinity ≥ 2.0 corresponding to a conductivity of ≥ 3.4 mS/cm at a reference temperature $T_{REF} = 20$ °C).</p>
<i>Sensor cap data</i>	<ul style="list-style-type: none"> ● Do not download ● Transmit to log book 	Generates a log book message with all data stored in the sensor cap when the settings are quit with <i>Save and quit</i> (see section 1.3). When opening the menu again the setting is reset to <i>Do not download</i> .
<i>Save and quit</i>		<p>The settings are stored.</p> <p>The display switches to the next higher level.</p>
<i>Quit</i>		<p>The settings are not stored.</p> <p>The display switches to the next higher level.</p>



For information on oxygen measurement in solutions that contain salt, see WTW application report no. 1193118.

4 Measurement / operation

4.1 Measuring



CAUTION

Contact with the sample can lead to danger to the user! Depending on the type of sample, suitable protective measures must be taken (protective clothing, protective goggles, etc.).

Note the data given in section 7.2 APPLICATION CONDITIONS, especially the minimum immersion depth of the sensor (10 cm). The measured value is available immediately on submersing.



If keeping the sensor clean is a problem, we recommend using the compressed air-driven cleaning system with the CH cleaning head (see section 5.5 REPLACEMENT PARTS AND ACCESSORIES).

4.2 Function check and user calibration

4.2.1 General information

Factory calibration

The FDO® 70x IQ F is factory calibrated. In the recommended application (see section 1.2 RECOMMENDED FIELDS OF APPLICATION), the measuring characteristics of the sensor cap remain stable for the specified service life. Thus, a user calibration is not usually required.

When does a function check or user calibration make sense?

A function check or user calibration can be useful in the following special cases:

- If the measured values appear to be implausible and it is assumed that the service life of the sensor cap is over
- Routinely within the framework of the company quality assurance

Check or calibration medium

Select one of the following two variants depending on the air temperature at the calibration site:

- With air temperatures over 5 °C, the function check and user calibration ideally take place in water vapor-saturated air. To do so, position the sensor approx. 2 cm above a water surface, for example in a narrow bucket or similar container with water. The membrane must be clean and dry for this.

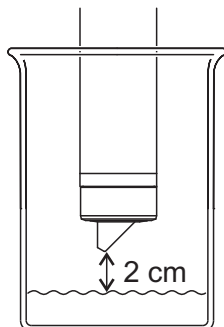

- With air temperatures under 5 °C we recommend performing the function check and user calibration not in air but in air-saturated water that has a higher temperature. You obtain air-saturated water by pouring water several times in and out of two vessels so that it sparkles.

4.2.2 Function check

A function check is the simplest way to determine whether the sensor needs to be cleaned or user-calibrated.

Principle

The function check can either be done in water vapor-saturated air or in air-saturated water (see CHECK OR CALIBRATION MEDIUM on page 13).

Outlet

Generally, a check on the DIQ/S 181 is carried out as follows. For details please refer to the DIQ/S 181 operating manual.

1	Switch to the measured value display with <M> .
2	Press <C> . The next step switches on the maintenance condition for the sensor. A message on this appears on the display.
3	Confirm the note with <OK> . The maintenance condition is active.
4	Select the <i>TEST</i> procedure and press <OK> .
5	Put the sensor into the calibration position (water vapor-saturated air or air-saturated water - see section 4.2.1).

6	<p>Press <OK>.</p> <p>The sensor starts the check. The display switches to the measured value display. The <i>CAL</i> indicator flashes instead of the main measured value. At the same time, the momentary relative slope flashes as the secondary measured value with the addition of <i>TEST</i>. The process ends automatically as soon as the measured values meet the criterion for the stability control. With a great temperature difference between the sensor and the environment this may take a while. Subsequently, the main measured value and temperature are displayed.</p>
7	Put the sensor in the measuring position again.
8	Wait for the measured value to be largely stable (temperature adjustment).
9	Switch off the maintenance condition.

Canceling the check

As long as the determination of the relative slope has not yet been started (step 6), you can quit the check with **<M>** or **<ESC>**.

The running determination of the relative slope (after pressing **<OK>** in step 6) can be aborted as follows:

1	Open the setting table (see section 3.4).
2	In the <i>Test</i> menu item, select the <i>abort</i> setting and then quit the setting table with <i>Save and quit</i> .

Evaluation

The result of the check is entered in the log book of the sensor. If the relative slope is outside the tolerance range (0.90 ... 1.10), the check is assessed as erroneous.

4.2.3 User calibration



We want to point out that the factory calibration of the membrane is highly precise due to the IQMC technology. If you still want to carry out a user calibration, influences due to environmental conditions have to be taken into account.

Principle

The user calibration can either be done in water vapor-saturated air or in air-saturated water (see CHECK OR CALIBRATION MEDIUM on page 13). With the calibration procedure, the relative slope of the sensor is determined. The calibration is evaluated based on the relative slope and the intensity (successful <-> unsuccessful).

The result of the user calibration is stored in the calibration protocol and

can be viewed afterwards (see DIQ/S 181 operating manual).

Outlet

Generally, a user calibration on the DIQ/S 181 is carried out as follows. For details please refer to the DIQ/S 181 operating manual.

1	Switch to the measured value display with <M> .
2	Press <C> . The next step switches on the maintenance condition for the sensor. A message on this appears on the display.
3	Confirm the note with <OK> . The maintenance condition is active.
4	Select the <i>CALIBRATION</i> procedure and press <OK> .
5	Put the sensor into the calibration position (water vapor-saturated air or air-saturated water - see section 4.2.1).
6	Press <OK> . The sensor determines the calibration data. The display switches to the measured value display. The <i>CAL</i> indicator flashes instead of the main measured value. At the same time, the momentary relative slope flashes as the secondary measured value. The process ends automatically as soon as the measured values meet the criterion for the stability control. With a great temperature difference between the sensor and the environment this may take a while. Subsequently, the main measured value and temperature are displayed.
7	If the user calibration was successful, bring the sensor into the measuring position again.
8	Wait for the measured value to be largely stable (temperature adjustment).
9	Switch off the maintenance condition.

Canceling the user calibration

As long as the determination of the calibration data has not yet been started (step 6), you can quit the calibration routine with **<M>** or **<ESC>**.

The running determination of calibration data (after pressing **<OK>** in step 6) can be aborted as follows:

1	Open the setting table (see section 3.4).
2	In the <i>Calibration</i> menu item, select the <i>abort</i> setting and then quit the setting table with <i>Save and quit</i> .

After the user calibration was canceled the sensor again works with the calibration data that was used before the canceled user calibration.

Possible results of the user calibration

The calibration data are evaluated by the DIQ/S 181. A calibration procedure can have the following results:

Display	Explanation
Measured value display	Sensor was successfully calibrated.
"----"	The sensor could not be calibrated. The sensor is blocked for further measurement. Notes on possible causes are given in the log book of the sensor.

4.2.4 Reactivating a valid calibration

The FDO® 70x IQ F enables you to reactivate the last valid user calibration or the factory calibration. Thus you can immediately continue to measure if a calibration failed or you suspect that the calibration conditions were not optimally met.



Reactivating old calibration data is a temporary measure. Take into consideration that the sensor may provide wrong measured values. Ensure the correct functioning of the sensor by checking and/or recalibrating it.

Reactivating calibration data

1	Open the setting table (see section 3.4).
2	In the <i>Calibration</i> menu item, select the <i>User calibration</i> or <i>Factory calibration</i> setting and then quit the setting table with <i>Save and quit</i> .

5 Maintenance, cleaning, replacement parts

5.1 General maintenance notes



CAUTION

Contact with the sample can lead to danger to the user! Depending on the type of sample, suitable protective measures must be taken (protective clothing, protective goggles, etc.).

Maintenance condition

We recommend switching on the maintenance condition each time before removing the sensor from its measuring position. This avoids unintended reactions of linked outputs. More detailed information on the maintenance condition is given in the DIQ/S 181 operating manual.

5.2 Handling of the sensor cap

Despite its exterior robustness, the sensor is a high precision optical instrument. Therefore, special care should be taken when doing any maintenance or cleaning work:

- Dirt and moisture under the sensor cap can affect the functioning and shorten the service life of the sensor cap. Therefore, make sure the working environment is clean and dry prior to removing the sensor cap.
- Please do not touch the outer sensor membrane with your fingers. Touch the sensor cap at the sides only (shaded area in figure on the left).
- Avoid any great mechanical stress of the sensor membrane (pressure, scratches).
- Exposure to light, particularly daylight, of the interior of the sensor cap will, by-and-by, affect the measurement characteristics and shorten the service life of the sensor cap. Therefore, the interior of the sensor cap should not be exposed to direct sunlight. Avoid any exposure to light that exceeds the extent required for necessary maintenance and cleaning activities. Store dismantled sensor caps in a light-protected environment only.

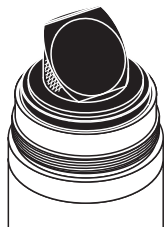

5.3 Exchanging the sensor cap

Removing the sensor cap

1	Pull the sensor out of the sample.
2	Clean the outside of the sensor (see section 5.4.1).

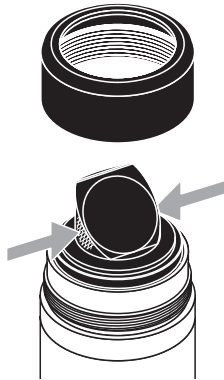

3	Unscrew the fixing ring from the sensor by hand.
4	Thoroughly clean and dry the sensor head once again.
5	Grasp the sensor cap on the sides (arrows in figure on the left) and remove it by pulling it away from the sensor in a <u>straight</u> upward direction.

NOTE

Do not push any tools or other sharp objects between the sealing surfaces. This might damage the sealing surfaces.

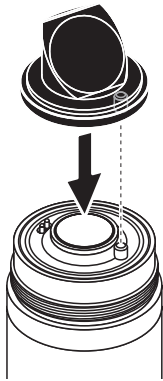
Mounting the sensor cap

6	Check the front surface of the sensor for absolute cleanness and clean it if necessary (see section 5.4.1).
7	Thoroughly clean the thread of the fixing ring.
8	Place the new sensor cap on the sensor so that the temperature sensor fits into the hole inside the sensor cap (see figure opposite).
9	Put the fixing ring on the sensor head and screw it tight by hand.

5.4 Cleaning the sensor**5.4.1 Exterior cleaning**

Extreme dirt on the sensor can affect the measuring characteristics. Biological deposits for example, consume oxygen and can, when occurring on the sensor cap membrane, impair the responding behavior and cause values that are too low. Therefore, we recommend regular visual inspections and exterior cleaning as necessary.

Pay attention to the following points for cleaning:

- First, thoroughly rinse the sensor with tapwater to remove loosely adhering dirt.
- Rough dirt on the sensor shaft can be brushed off with a soft brush. Attention: Do not use the brush in the area of the sensor membrane. Risk of damage!
- The sensor cap including the sensor membrane should be wiped with a soft and moist microfiber cloth.
- In the case of persisting dirt you can add some household washing-up liquid to the tapwater. Attention: Never use any alcohol for cleaning!

- If there are any salt or lime deposits, the sensor can be cleaned with aqueous citric acid solution (10 percent by weight).

5.4.2 Interior cleaning of sensor cap and sensor head

If moisture or dirt have penetrated under the sensor cap, e.g. because the sensor cap is damaged, you can make the sensor ready for operation again as follows:

NOTE

Only use nonabrasive, alcohol-free detergents, as otherwise the optical surfaces could be damaged.

1	Remove the sensor cap (see section 5.3).
2	Clean the sensor head and sensor cap: <ul style="list-style-type: none"> – Rinse all inner surfaces with tapwater – Remove contamination containing fat and oil with warm water and household washing-up liquid
3	Dry all surfaces with a clean, lint free cloth. A lint-free cloth such as a microfiber cloth used to clean eyeglasses is suitable.
4	Allow the sensor and sensor cap to dry completely at a dry location so moisture can evaporate even from corners difficult to access. When doing so, protect the inside of the sensor cap from light.



If the sensor cap is visibly damaged it has to be replaced.

5.5 Replacement parts and accessories

Description	Model	Order no.
Sensor cap	SC-FDO® 700	201 654
Sensor cap	SC-FDO® 701	201 655
Protective hood against damage caused by fish, with connection for the MSK FDO® CS cleaning set	MSK FDO®	205 253

Description	Model	Order no.
Cleaning set for FDO® 70x IQ F in conjunction with protective hood MSK FDO®	MSK FDO® CS	205 254

**Components for
compressed air cleaning
system**

Description	Model	Order no.
Cleaning head	CH	900 107
Valve module for the DIQ/S 181 (external relay and compressed air supply)	DIQ/CHV	472 007
Air compressor to be triggered by relay, power supply 115 V AC	Cleaning Air Box - 115 VAC	480 017
Air compressor to be triggered by relay, power supply 230 V AC	Cleaning Air Box - 230 VAC	480 019

5.6 Disposal

**Sensor
Sensor cap**

We recommend disposing of the sensor and sensor caps as electronic refuse.

6 What to do if...

Sensor does not appear in the measured value display and list of components

Cause	Remedy
Sensor cap not mounted or defective	<ul style="list-style-type: none"> – Sensor cap (see section 5.3) – Replace a defective sensor cap as necessary

Measured value implausible

Cause	Remedy
Coating on sensor cap	Clean the outside of the sensor (see section 5.4.1)
Service life of the sensor cap over	<ul style="list-style-type: none"> – Check the sensor (see section 4.2.2) – Replace the sensor cap as necessary (see section 5.3)
Dirt inside the sensor cap and sensor head.	<ul style="list-style-type: none"> – Dismantle the sensor cap – Clean the insides of the sensor cap and sensor head (see section 5.4.2)
Fixing ring not properly tightened.	Mount the sensor cap correctly and tighten the fixing ring as far as it will go (see section 5.3)
Sensor cap untight or defective.	Replace a defective sensor cap as necessary

Measured value fluctuating heavily

Cause	Remedy
Coating on sensor cap	See point "Measured value implausible"
Service life of the sensor cap over	
Dirt inside the sensor cap and sensor head.	
Fixing ring not properly tightened.	
Sensor cap untight or defective.	

Measured value invalid ("-----" displayed)	Cause User calibration unsuccessful. The sensor is blocked for measurement.	Remedy – As a temporary measure to quickly restore the readiness for service: Activate the factory calibration (see section 4.2.4) – For exact measurements, carry out a function check and repeat the user calibration if necessary.
Incorrect temperature display	Cause Temperature sensor defective	Remedy Return the sensor
Measured value flashing	Cause Maintenance condition is active	Remedy – If the maintenance condition was activated manually (e.g. by pressing the <C> key): Switch off the maintenance condition manually in the menu <i>PROPERTIES</i> (see DIQ/S 181 operating manual) – If the maintenance condition was activated automatically (e.g. by the cleaning system): The maintenance condition will be deactivated automatically

7 Technical data

7.1 General measurement characteristics



The measurement characteristics are primarily determined by the sensor cap type. The relevant data are given in the sections 7.5 and 7.6.

Measuring principle	Optical measurement based on photoluminescence.								
Measurement in water	According to solubility function according to ISO 5814								
Measurement in salt-contaminated wastewater	Salinity input from 2.0 ... 70.0; corresponds to 3.4 mS/cm ... 86.2 mS/cm at T _{REF} 20 °C (salinity measurement according to IOT = International Oceanographic Tables)								
Temperature measurement	<table border="1" style="width: 100%; border-collapse: collapse;"> <tr> <td style="padding: 2px;">Temperature sensor</td> <td style="padding: 2px;">Integrated NTC</td> </tr> <tr> <td style="padding: 2px;">Measuring range</td> <td style="padding: 2px;">- 5 °C ... + 50 °C (23 ... 122 °F)</td> </tr> <tr> <td style="padding: 2px;">Accuracy</td> <td style="padding: 2px;">± 0.5 K</td> </tr> <tr> <td style="padding: 2px;">Resolution</td> <td style="padding: 2px;">0.1 K</td> </tr> </table>	Temperature sensor	Integrated NTC	Measuring range	- 5 °C ... + 50 °C (23 ... 122 °F)	Accuracy	± 0.5 K	Resolution	0.1 K
Temperature sensor	Integrated NTC								
Measuring range	- 5 °C ... + 50 °C (23 ... 122 °F)								
Accuracy	± 0.5 K								
Resolution	0.1 K								
Temperature compensation	In the range -5 °C ... + 50 °C (23 ... 122 °F)								
7.2 Application conditions									
Pressure resistance	<p>Sensor with connection cable:</p> <table border="1" style="width: 100%; border-collapse: collapse;"> <tr> <td style="padding: 2px;">Max. allowed overpressure</td> <td style="padding: 2px;">10⁵ Pa (1 bar)</td> </tr> <tr> <td style="padding: 2px;">Max. allowed overpressure with installation in a pipe</td> <td style="padding: 2px;">10⁶ Pa (10 bar)</td> </tr> </table> <p>The sensor meets all requirements according to article 3(3) of 97/23/EG ("pressure equipment directive").</p>	Max. allowed overpressure	10 ⁵ Pa (1 bar)	Max. allowed overpressure with installation in a pipe	10 ⁶ Pa (10 bar)				
Max. allowed overpressure	10 ⁵ Pa (1 bar)								
Max. allowed overpressure with installation in a pipe	10 ⁶ Pa (10 bar)								
Type of protection	IP 68, 1 bar (10 ⁵ Pa)								
Depth of immersion	min. 10 cm; max. 10 m depth								
Operating position	Any								

7.3 General data

Dimensions

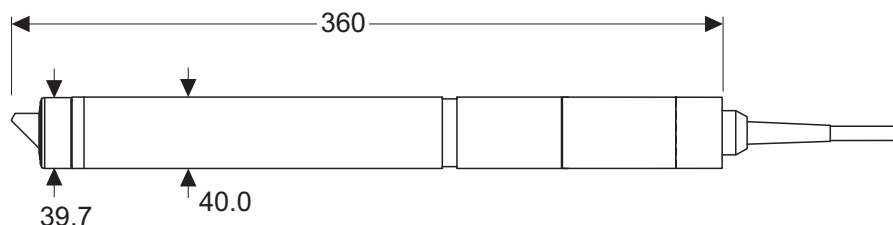

Weight (with sensor cable)	FDO® 70x IQ F	Approx. 1100 g
Material	Shaft	V4A stainless steel 1.4571 *
	Plug head connector housing	POM
	Sensor head	POM and PVC
	Sensor cap	See section 7.5 or section 7.6
	Plug, 3-pole	ETFE (blue) Tefzel®
	Fixing ring	POM
Automatic sensor monitoring (SensCheck function)	Monitoring of the membrane function	
Instrument safety	Applicable norms	<ul style="list-style-type: none"> – EN 61010-1 – UL 3111-1 – CAN/CSA C22.2 No. 1010.1

* Stainless steel can be corrodible if there are chloride concentrations of 500 mg/L or more.

7.4 Electrical data

Nominal voltage	max. 24 VDC via the DIQ/S 181 (details see chapter TECHNICAL DATA of the DIQ/S 181 operating manual)
Power consumption	0.7 W
Protective class	III

7.5 Technical data of the SC-FDO® 700

Measuring ranges and resolution

D. O. partial pressure 0 ... 400 hPa

Measuring mode	Adjustable measuring range	Resolution
D. O. concentration	0 ... 20.00 mg/L 0 ... 20.00 ppm	0.01 mg/L 0.01 ppm
D. O. saturation	0 ... 200.0 %	0.1 %

Measurement accuracy

in the range	Accuracy
< 1 mg/L (ppm)	± 0.05 mg/L (ppm)
> 1 mg/L (ppm)	± 0.1 mg/L (ppm)

Repeatability

± 0.05 mg/L (ppm) according to EN ISO 15839

Response time

t₉₀ (90 % of the final display value after) < 150 s according to EN ISO 15839
t₉₅ (95 % of the final display value after) < 200 s according to EN ISO 15839

Minimum approach flow

No incident flow required

Interferences

Non-sensitive to hydrogen sulfide, chlorine, and ionogenic substances

Allowed temperature range

Measuring medium	-5 °C ... + 50 °C (23 ... 122 °F)
Storage/transport	- 10 °C ... + 50 °C (14 ... 122 °F)

Allowed pH range of the measuring medium

4 ... 12

Calibration procedures

Factory calibration by means of IQMC (Intelligent Membrane Calibration) procedure. User calibration possible in water vapor-saturated air or air-saturated water.

Materials

PMMA, PVC and silicone

Working life

2 years guaranteed with authorized use

7.6 Technical data of the SC-FDO® 701

Measuring ranges and resolution

D. O. partial pressure 0 ... 400 hPa

Measuring mode	Adjustable measuring range	Resolution
D. O. concentration	0 ... 20.00 mg/L 0 ... 20.00 ppm	0.01 mg/L 0.01 ppm
D. O. saturation	0 ... 200.0 %	0.1 %

Measurement accuracy

in the range	Accuracy
< 1 mg/L (ppm)	± 0.05 mg/L (ppm)
> 1 mg/L (ppm)	± 0.1 mg/L (ppm)

Repeatability

± 0.05 mg/L (ppm) according to EN ISO 15839

Response time

t_{90} (90 % of the final display value after) < 60 s according to EN ISO 15839
 t_{95} (95 % of the final display value after) < 80 s according to EN ISO 15839

Minimum approach flow

No incident flow required

Interferences

Non-sensitive to hydrogen sulfide, chlorine, and ionogenic substances

Allowed temperature range

Measuring medium	- 5 °C ... + 40 °C (23 ... 104 °F)
Storage/transport	- 10 °C ... + 50 °C (14 ... 122 °F)

Allowed pH range of the measuring medium

4 ... 12

Calibration procedures

Factory calibration by means of IQMC (Intelligent Membrane Calibration) procedure. User calibration possible in water vapor-saturated air or air-saturated water.

Materials

PMMA, PVC and silicone

Working life

6 months guaranteed for authorized use under the specified environmental conditions

8 Indexes

8.1 Explanation of the messages

This chapter contains a list of all the message codes and related message texts for the FDO® 70x IQ F sensor.



Information on

- the contents and structure of the log book and
- the structure of the message code

see DIQ/S 181 operating manual, chapter LOG BOOK.

8.1.1 Error messages

Message code	Message text
EA1	<i>Meas. range exceeded or undercut</i> * <i>Check process</i> * <i>Select other meas. range</i>
EA2	<i>Sensor temperature too high!</i> * <i>Check process and application</i>
EA3	<i>Sensor temperature too low!</i> * <i>Check process and application</i>
EAP	<i>Measurement interfered</i> * <i>SensCheck: Sensor cap is missing, leaky, depleted, or defective</i> * <i>Clean sensor and space between cap and sensor according to op.instructions</i> * <i>Screw on sensor cap securely</i> * <i>Replace sensor cap</i>
EC8	<i>Sensor could not be calibrated, sensor blocked for measurement</i> <i>Cause: instable signal</i> * <i>Check temperature adjustment</i> * <i>Check calibration conditions (see operating manual)</i> * <i>Repeat calibration</i>
EC9	<i>Calibration error, measurement disabled</i> <i>Cause: Sensor cap is missing, leaky, depleted, or defective</i> * <i>Clean sensor and space between cap and sensor according to op.instructions</i> * <i>Screw on sensor cap securely</i> * <i>Repeat calibration</i> * <i>Replace sensor cap</i>

Message code	Message text
EI3	<i>Operational voltage too low</i> <i>* Check installation and cable lengths, Follow installation instructions</i> <i>* Power supply module overloaded</i> <i>* Check terminal and module connections</i> <i>* Defective component, replace components</i>
EI4	<i>Operational voltage too low, no operation possible</i> <i>* Check installation and cable lengths, Follow installation instructions</i> <i>* Power supply module overloaded</i> <i>* Check terminal and module connections</i> <i>* Defective component,</i> <i>replace components</i>
ES1	<i>Component hardware defective</i> <i>* Contact service</i>

8.1.2 Informative messages

Message code	Message text
IC1	<i>Sensor has been successfully calibrated * For calibration data, see calibration history</i>
IC3	<i>Factory calibration has been activated. Make sure the sensor operates correctly.</i>
IC4	<i>Last valid calibration has been activated. Make sure the sensor operates correctly.</i>
IC5	<i>Invalid user calibration has been replaced by last valid user calibration. Caution! Wrong measured values possible. Carry out a new successful calibration to make sure the sensor operates correctly.</i>
IC6	<i>The invalid user calibration was replaced by the factory calibration. Caution! Wrong measured values possible. Check whether the sensor operates correctly or carry out a new successful calibration.</i>
IC7	This message displays the result of the last check (see section 4.2.2)
IS1	This message displays the information stored in the sensor cap (see section 1.3)

Xylem | 'zīləm|

- 1) The tissue in plants that brings water upward from the roots;
- 2) a leading global water technology company.

We're a global team unified in a common purpose: creating advanced technology solutions to the world's water challenges. Developing new technologies that will improve the way water is used, conserved, and re-used in the future is central to our work. Our products and services move, treat, analyze, monitor and return water to the environment, in public utility, industrial, residential and commercial building services settings. Xylem also provides a leading portfolio of smart metering, network technologies and advanced analytics solutions for water, electric and gas utilities. In more than 150 countries, we have strong, long-standing relationships with customers who know us for our powerful combination of leading product brands and applications expertise with a strong focus on developing comprehensive, sustainable solutions.

For more information on how Xylem can help you, go to www.xylem.com.



Service and Returns:

Xylem Analytics Germany
Sales GmbH & Co. KG
WTW
Am Achalaich 11
82362 Weilheim
Germany

Tel.: +49 881 183-325
Fax: +49 881 183-414
E-Mail wtw.rma@xylem.com
Internet: www.xylemanalytics.com



Xylem Analytics Germany GmbH
Am Achalaich 11
82362 Weilheim
Germany

