



Multi 3510 IDS

DIGITAL METER FOR DIGITAL IDS SENSORS (pH/ORP/D.O./COND)



a xylem brand

Copyright

© 2021 Xylem Analytics Germany GmbH
Printed in Germany.

Contents

1	Overview	7
1.1	Multi 3510 IDS meter	7
1.2	Sensors	7
1.2.1	IDS sensors	8
1.2.2	Wireless operation of IDS sensors	8
1.2.3	IDS adapter for analog sensors	9
1.2.4	Automatic sensor recognition	9
2	Safety	11
2.1	Safety information	11
2.1.1	Safety information in the operating manual	11
2.1.2	Safety signs on the meter	11
2.1.3	Further documents providing safety information	11
2.2	Safe operation	12
2.2.1	Authorized use	12
2.2.2	Requirements for safe operation	12
2.2.3	Unauthorized use	12
3	Commissioning	13
3.1	Scope of delivery	13
3.2	Power supply	13
3.3	Initial commissioning	13
3.3.1	Inserting the batteries	14
4	Operation	15
4.1	General operating principles	15
4.1.1	Keypad	15
4.1.2	Display	16
4.1.3	Status information (meter)	16
4.1.4	Instrument connectors	17
4.1.5	Sensor info	17
4.2	Switching on the meter	18
4.3	Switching off the meter	19
4.4	Login with a user name	19
4.5	Navigation	20
4.5.1	Operating modes	20
4.5.2	Measured value display	21
4.5.3	Menus and dialogs	21
4.5.4	Example 1 on navigation: Setting the language	23
4.5.5	Example 2 on navigation: Setting the date and time	24

5	pH value	26
5.1	Measuring	26
5.1.1	Measuring the pH value	26
5.1.2	Measuring the temperature	27
5.2	pH calibration	28
5.2.1	Why calibrate?	28
5.2.2	When do you have to calibrate?	28
5.2.3	Carrying out automatic calibration (AutoCal)	28
5.2.4	Carrying out manual calibration (ConCal)	31
5.2.5	Calibration points	34
5.2.6	Calibration data	35
5.2.7	Continuous measurement control (CMC function) ..	37
5.2.8	QSC function (sensor quality control)	38
6	ORP	41
6.1	Measuring	41
6.1.1	Measuring the ORP	41
6.1.2	Measuring the temperature	43
6.2	ORP calibration	43
7	Dissolved oxygen	44
7.1	Measuring	44
7.1.1	Measuring D.O.	44
7.1.2	Measuring the temperature	46
7.2	FDO [®] Check procedure	47
7.2.1	Why should you check the sensor?	47
7.2.2	When should you check the sensor?	47
7.2.3	Carrying out the FDO [®] Check procedure	47
7.2.4	Evaluation	48
7.3	Calibration	49
7.3.1	Why calibrate?	49
7.3.2	When to calibrate?	49
7.3.3	Calibration procedures	49
7.3.4	Calibration in water vapor-saturated air	49
7.3.5	Calibration by means of a <i>Comparison meas.</i> (FDO Comp) 50	
7.3.6	Calibration data	51
8	Conductivity	54
8.1	Measuring	54
8.1.1	Measuring the conductivity	54
8.1.2	Measuring the temperature	55
8.2	Temperature compensation	56
8.3	Calibration	57
8.3.1	Why calibrate?	57
8.3.2	When to calibrate?	57
8.3.3	Determining the cell constant (calibration in control standard)	57
8.3.4	Calibration data	58

9	Turbidity measurement (VisoTurb® 900-P)	60
9.1	Measuring	60
9.1.1	Measuring the turbidity	60
9.2	Calibration	62
9.2.1	Why calibrate?	62
9.2.2	When to calibrate?	62
9.2.3	Calibration standards	63
9.2.4	Carry out calibration	63
9.2.5	Calibration data	65
10	Settings	67
10.1	pH measurement settings	67
10.1.1	Settings for pH measurements	67
10.1.2	Buffer sets for calibration	68
10.1.3	Calibration interval	70
10.2	ORP measurement settings	71
10.2.1	Settings for ORP measurements	71
10.3	D.O. measurement settings	71
10.3.1	Settings for D.O. sensors (menu for measurement and calibration settings)	71
10.4	Cond measurement settings	73
10.4.1	Settings for IDS conductivity sensors	73
10.5	Turb measurement settings	75
10.5.1	Settings for turbidity sensors	75
10.6	Sensor-independent settings	76
10.6.1	<i>System</i>	76
10.6.2	<i>Data storage</i>	77
10.6.3	<i>Automatic Stability control</i>	77
10.6.4	Automatic shutoff function	77
10.6.5	Display illumination	77
10.7	Reset	78
10.7.1	Resetting the measurement settings	78
10.7.2	Resetting the system settings	80
11	Data storage	81
11.1	Manual data storage	81
11.2	Automatic data storage at intervals	82
11.3	Measured value data storage	84
11.3.1	Editing the measured value data storage	84
11.3.2	Erasing the measurement data storage	85
11.3.3	Measurement dataset	85
11.3.4	Storage locations	86
12	Transmitting data (USB interfaces)	87
12.1	Outputting current measurement data	87
12.2	Transmitting data (to a PC)	87
12.3	Connecting the PC / USB-B interface (<i>USB Device</i>)	87
12.4	Options for data transmission to a PC	88
12.5	MultiLab Importer	88

13	Maintenance, cleaning, disposal	89
13.1	Maintenance	89
13.1.1	General maintenance activities	89
13.1.2	Replacing the batteries	89
13.2	Cleaning	90
13.3	Packing	90
13.4	Disposal	90
14	What to do if...	91
14.1	pH	91
14.2	Dissolved oxygen	92
14.3	Conductivity	93
14.4	Turbidity	93
14.5	General information	94
15	Technical data	97
15.1	Measuring ranges, resolution, accuracy	97
15.2	General data	97
16	Firmware update	99
16.1	Firmware update for the meter Multi 3510 IDS	99
16.2	Firmware-Update for IDS Sensors	100
17	Glossary	101
18	Index	105

1 Overview

1.1 Multi 3510 IDS meter

The Multi 3510 IDS meter enables you to perform measurements (pH, U, ISE, conductivity, D.O. turbidity) quickly and reliably.

The Multi 3510 IDS provides the maximum degree of operating comfort, reliability and measuring certainty for all applications.

The Multi 3510 IDS supports you in your work with the following functions:

- Automatic sensor recognition
- CMC (continuous measurement control)
- QSC (sensor quality control)
- Electronic access control
- Data transmission via the USB interface (USB-B).

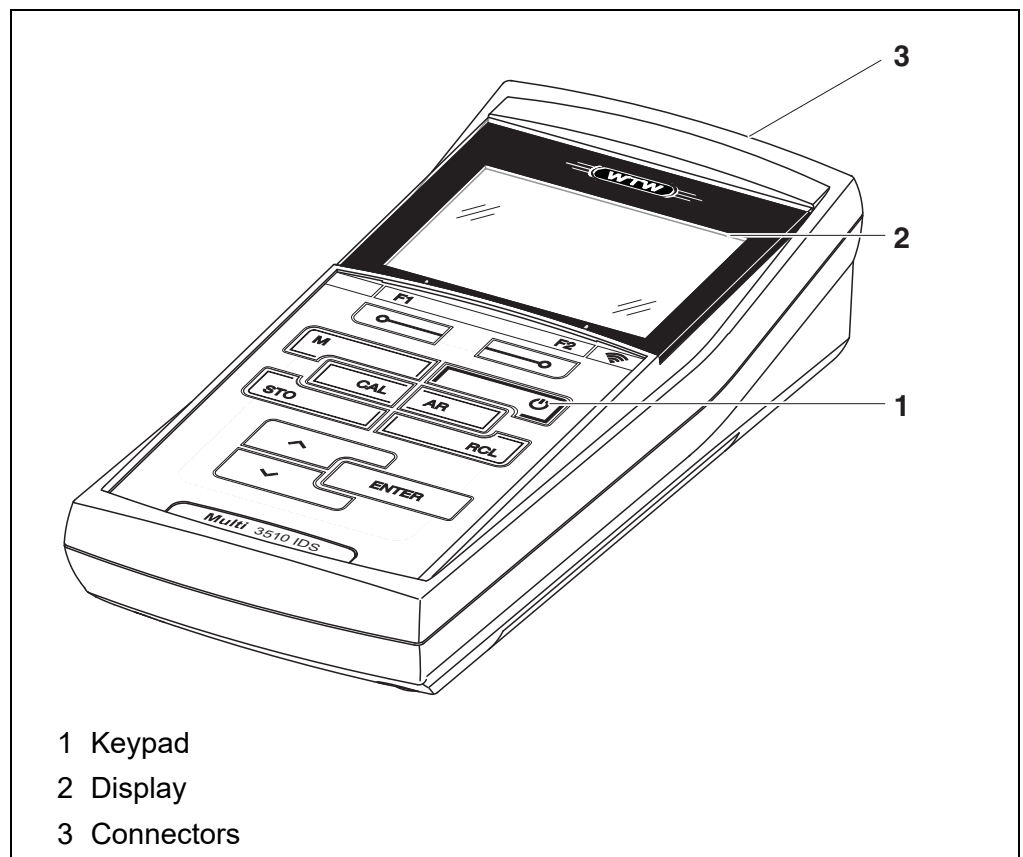

1.2 Sensors

A measuring system ready to measure consists of the Multi 3510 IDS meter and a suitable sensor.

Suitable sensors are IDS pH sensors, IDS ORP sensors, IDS conductivity sensors and IDS D.O. sensors.



Information on available IDS sensors and IDS adapters is given on the Internet .



You can also operate non-IDS sensors with the aid of an IDS adapter on the Multi 3510 IDS. The advantages of the sensor recognition, however, are not available in this case.

1.2.1 IDS sensors

IDS sensors

- support the automatic sensor recognition
- show only the settings relevant to the specific sensor in the setting menu
- process signals in the sensor digitally so that precise and interference-free measurements are enabled even with long cables
- facilitate to assign a sensor to a measured parameter with differently colored couplings
- have quick-lock couplings with which to fix the sensors to the meter.

Sensor data from IDS sensors

IDS sensors transmit the following sensor data to the meter:

- SENSOR ID
 - Sensor name
 - Sensor series number
- Calibration data
- Measurement settings

The calibration data are updated in the IDS sensor after each calibration procedure. A message is displayed while the data are being updated in the sensor.



In the measured value display, you can display the sensor name and series number of the selected sensor with the [**i**] softkey. You can then display further sensor data stored in the sensor with the [More] softkey (see section 4.1.5 SENSOR INFO, page 17).

1.2.2 Wireless operation of IDS sensors

With the aid of the adapters in the IDS WLM System, IDS sensors with plug head connectors (variant P) can be wirelessly connected to your Multi 3510 IDS.



Further information on the wireless operation of IDS sensors:

- Web resources
- Operating manual of the IDS WLM System.

1.2.3 IDS adapter for analog sensors

With the aid of an IDS adapter, you can also operate analog sensors on the Multi 3510 IDS. The combination of the IDS adapter and analog sensor behaves like an IDS sensor.

The measuring electronics with the stored adapter data are in the adapter head. The adapter data correspond to the sensor data.



Information on available IDS adapters is given on the Internet. Detailed information on the IDS adapter is given in the operating manual of the adapter.

1.2.4 Automatic sensor recognition

The automatic sensor recognition for IDS sensors allows

- to operate an IDS sensor with different meters without recalibrating
- to assign measurement data to an IDS sensor
 - Measurement datasets are always stored and output with the sensor name and sensor series number.
- to assign calibration data to an IDS sensor
 - Calibration data and calibration history are always stored and output with the sensor name and sensor series number.
- to hide menus automatically that do not concern this sensor

To be able to use the automatic sensor recognition, a meter that supports the automatic sensor recognition (e.g. Multi 3510 IDS) and a digital IDS sensor are required.

In digital IDS sensors, sensor data are stored that clearly identify the sensor. The sensor data are automatically taken over by the meter.

2 Safety

2.1 Safety information

2.1.1 Safety information in the operating manual

This operating manual provides important information on the safe operation of the meter. Read this operating manual thoroughly and make yourself familiar with the meter before putting it into operation or working with it. The operating manual must be kept in the vicinity of the meter so you can always find the information you need.

Important safety instructions are highlighted in this operating manual. They are indicated by the warning symbol (triangle) in the left column. The signal word (e.g. "Caution") indicates the level of danger:



WARNING

indicates a possibly dangerous situation that can lead to serious (irreversible) injury or death if the safety instruction is not followed.



CAUTION

indicates a possibly dangerous situation that can lead to slight (reversible) injury if the safety instruction is not followed.

NOTE

indicates a possibly dangerous situation where goods might be damaged if the actions mentioned are not taken.

2.1.2 Safety signs on the meter

Note all labels, information signs and safety symbols on the meter and in the battery compartment. A warning symbol (triangle) without text refers to safety information in this operating manual.

2.1.3 Further documents providing safety information

The following documents provide additional information, which you should observe for your safety when working with the measuring system:

- Operating manuals of sensors and other accessories
- Safety datasheets of calibration or maintenance accessories (such as buffer solutions, electrolyte solutions, etc.)

2.2 Safe operation

2.2.1 Authorized use

The authorized use of the meter consists exclusively of the measurement of the pH, ORP, conductivity and dissolved oxygen in a laboratory environment.

Only the operation and running of the meter according to the instructions and technical specifications given in this operating manual is authorized (see section 15 TECHNICAL DATA, page 97).

Any other use is considered unauthorized.

2.2.2 Requirements for safe operation

Note the following points for safe operation:

- The meter may only be operated according to the authorized use specified above.
- The meter may only be supplied with power by the energy sources mentioned in this operating manual.
- The meter may only be operated under the environmental conditions mentioned in this operating manual.
- The meter may only be opened if this is explicitly described in this operating manual (example: Inserting the batteries).

2.2.3 Unauthorized use

The meter must not be put into operation if:

- it is visibly damaged (e.g. after being transported)
- it was stored under adverse conditions for a lengthy period of time (storing conditions, see section 15 TECHNICAL DATA, page 97).

3 Commissioning

3.1 Scope of delivery

- Meter Multi 3510 IDS
- 4 batteries 1.5 V Mignon type AA
- Short instructions
- CD-ROM with
 - USB drivers
 - comprehensive operating manual (4 languages)
 - software MultiLab User
 - software MultiLab Importer

3.2 Power supply

The Multi 3510 IDS is supplied with power in the following ways:

- Battery operation (4 batteries, 1.5 V Mignon type AA)
- USB operation via a connected USB-B cable

3.3 Initial commissioning

Perform the following activities:

- Insert the supplied batteries
- Switch on the meter (see section 4.2 SWITCHING ON THE METER, page 18)
- Set the date and time (see section 4.5.5 EXAMPLE 2 ON NAVIGATION: SETTING THE DATE AND TIME, page 24)

3.3.1 Inserting the batteries



You can operate the meter either with normal batteries or with rechargeable batteries (Ni-MH). In order to charge the batteries, an external charging device is required.

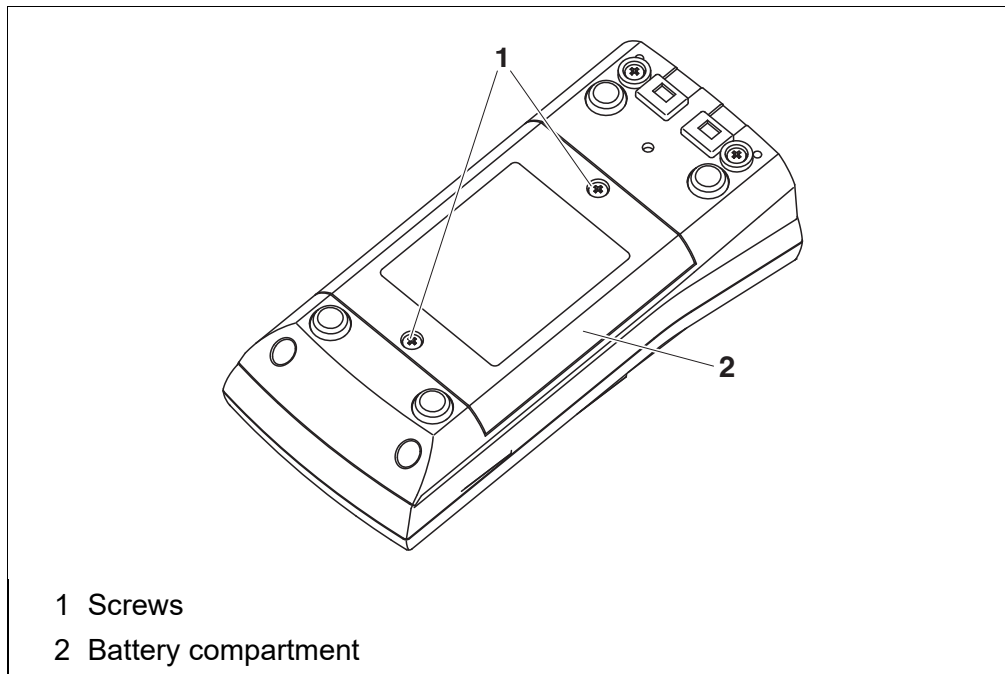

1. Unscrew the two screws (1) on the underside of the meter.
2. Open the battery compartment (2) on the underside of the meter.



CAUTION

Make sure that the poles of the batteries are positioned correctly.

The \pm signs on the batteries must correspond to the \pm signs in the battery compartment.

3. Place four batteries (type Mignon AA) in the battery compartment.
4. Close the battery compartment (2).
5. Set the date and time
(see section 4.5.5 EXAMPLE 2 ON NAVIGATION: SETTING THE DATE AND TIME, page 24).

4 Operation

4.1 General operating principles

4.1.1 Keypad

In this operating manual, keys are indicated by brackets <..>. The key symbol (e.g. <ENTER>) generally indicates a short keystroke (press and release) in this operating manual. A long keystroke (press and hold for approx. 2 sec) is indicated by the underscore behind the key symbol (e.g. <ENTER_ >).

<F1>: <F1_>: <F2>: <F2_>:	Softkeys providing situation dependent functions, e.g.: <F1>/[Info]: View information on a sensor
<On/Off>:	Switches the meter on or off
<M>:	Selects the measured parameter / Quits the settings
<CAL>: <CAL_>:	Calls up the calibration procedure Displays the calibration data
<STO>: <STO_ >:	Saves a measured value manually Opens the menu for the automatic save function
<RCL>: <RCL_>:	Displays the manually stored measured values Displays the automatically stored measured values
<▲ ><▼ >: <▲ _><▼ _>:	Menu control, navigation Increments, decrements values Increments, decrements values continuously
<ENTER>: <ENTER_ >:	Opens the menu for measurement settings / confirms entries Opens the menu for system settings
<AR>	Freezes the measured value (HOLD function) Switches the AutoRead measurement on or off

4.1.2 Display

Example (pH):

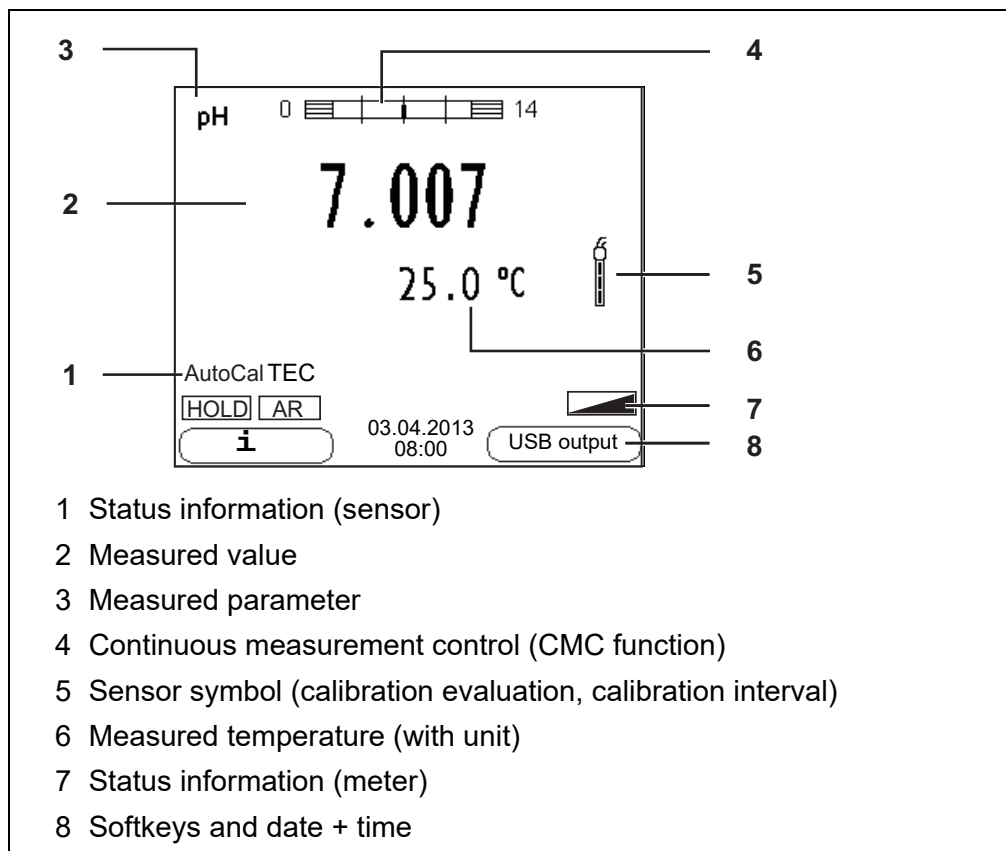

- 1 Status information (sensor)
- 2 Measured value
- 3 Measured parameter
- 4 Continuous measurement control (CMC function)
- 5 Sensor symbol (calibration evaluation, calibration interval)
- 6 Measured temperature (with unit)
- 7 Status information (meter)
- 8 Softkeys and date + time

4.1.3 Status information (meter)

AR	Stability control (AutoRead) is active
HOLD	Measured value is frozen (<AR> key)
	Batteries are almost empty
	Data are automatically output to the USB-B interface at intervals

4.1.4 Instrument connectors

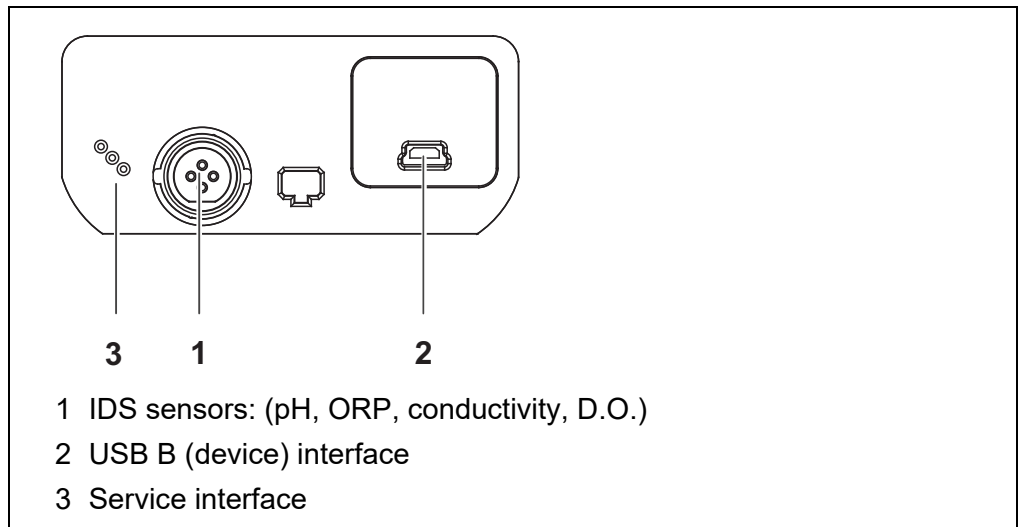

CAUTION

Only connect sensors to the meter that cannot return any voltages or currents that are not allowed (> SELV and > current circuit with current limiting).

WTW IDS sensors and IDS adapters meet these requirements.

4.1.5 Sensor info

You can display the current sensor data and sensor settings of a connected sensor at any time. The sensor data are available in the measured value display with the <F1>/[Info] softkey.

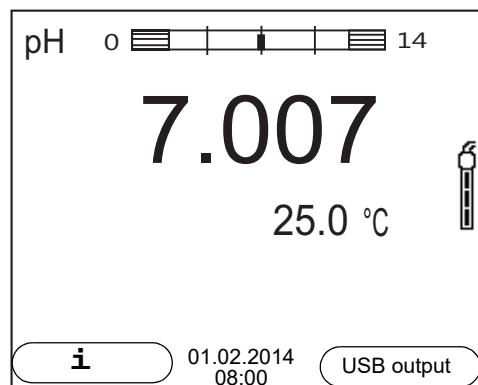

1. In the measured value display:
Display the sensor data (sensor name, series number) with [<F1>Info].

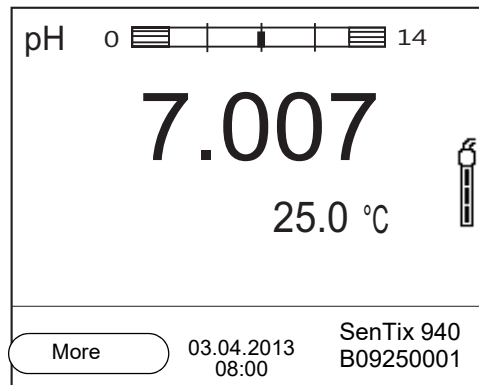

2. Display further sensor data (settings) with **<F1>/[More]**.

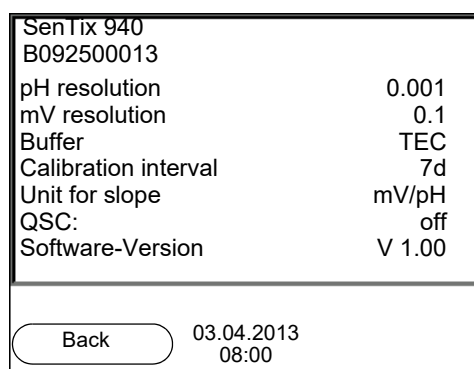

4.2 Switching on the meter

1. Switch the meter on with **<On/Off>**.
The meter performs a self-test.
2. Connect the sensor.
The meter is ready to measure.

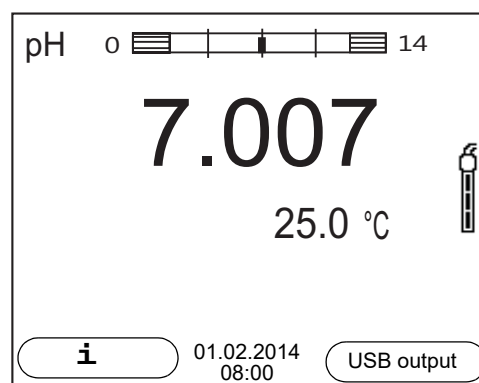

If the user administration function is activated, the *Login* dialog appears after the meter is switched on (see section 4.4 LOGIN WITH A USER NAME, page 19).
The user administration function is not active in the delivery condition.

4.3 Switching off the meter

1. Switch the meter off with **<On/Off>**.

4.4 Login with a user name

After activation of the user administration by the administrator (software MultiLab User, on the enclosed CD-ROM), measurements are only possible after login with a user name. The user name is documented with the measured values and in records.

All user names entered by the administrator are listed in the *User name* menu. The administrator determines for each user whether or not a password is required for the login to the meter.

If the *Password* menu item is grayed out, no password is required for the login.

1. Switch the meter on with **<On/Off>**.
The *Login* dialog appears.

Login	
User name	Admin
Password	####
Change password	
03.04.2013 08:00	

2. Using **<▲ ><▼ >**, select the menu item, *User name* and confirm with **<ENTER>**.
The user name is highlighted.
3. Using **<▲ ><▼ >**, select a user name and confirm with **<ENTER>**.



The login is done immediately if no password is required. If a sensor is connected the measured value display appears.

4. If a password is required:
Using **<▲ ><▼ >**, select the menu item, *Password* and confirm with **<ENTER>**.



The user specifies the password when he or she first logs in with a user name.

A valid password consists of 4 digits.

The user can change the password with the next login.

5. Change the digit of the highlighted position with **<▲ ><▼ >**.
Go to the next digit of the password with **<F2>/[▶]**.
When the password was completely entered, confirm with **<ENTER>**.
The login takes place. If a sensor is connected the measured value display appears.

Changing the password

If the administrator has set up the access with password protection:

1. Switch the meter on with **<On/Off>**.
The *Login* dialog appears.
2. Using **<▲ ><▼ >**, select the menu item, *User name* and confirm with **<ENTER>**.
The user name is highlighted.
3. Using **<▲ ><▼ >**, select a user name and confirm with **<ENTER>**.
4. Using **<▲ ><▼ >**, select the menu item, *Change password* and confirm with **<ENTER>**.
5. In the *Password* field, enter the old password with **<▲ ><▼ >** and **<F2>/[▶]** and confirm it with **<ENTER>**.
6. In the *New password* field, enter the new password with **<▲ ><▼ >** and **<F2>/[▶]** and confirm it with **<ENTER>**.
The password is changed.
The login takes place. If a sensor is connected the measured value display appears.

Forgotten the password?

Contact the administrator.

4.5 Navigation

4.5.1 Operating modes

Operating mode	Description
Measuring	The measurement data of the connected sensor are shown in the measured value display
Calibration	The course of a calibration with calibration information, functions and settings is displayed
Storing in memory	The meter stores measuring data automatically or manually

Operating mode	Description
Transmitting data	The meter transmits measuring data and calibration records to a USB-B interface automatically or manually.
Setting	The system menu or a sensor menu with submenus, settings and functions is displayed

4.5.2 Measured value display

In the measured value display, you can

- open the menu for calibration and measurement settings with **<ENTER>** (short keystroke)
- open the *Storage & config* system menu with the sensor-independent settings by pressing **<ENTER_ >** (long keystroke, approx. 2 s).
- change the display in the selected measuring screen (e. g. pH ><- mV) by pressing **<M>**.

4.5.3 Menus and dialogs

The menus for settings and dialogs in procedures contain further subelements. The selection is made with the **<▲ ><▼ >** keys. The current selection is displayed with a frame.

- Submenus

The name of the submenu is displayed at the upper edge of the frame. Submenus are opened by confirming with **<ENTER>**. Example:

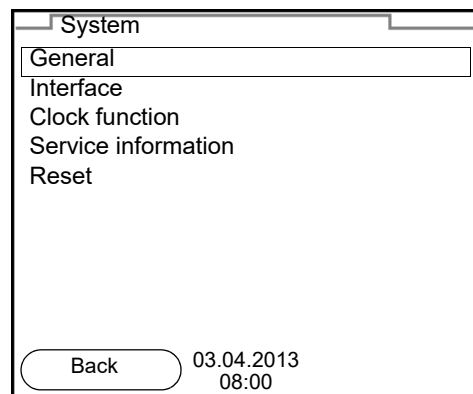

- Settings

Settings are indicated by a colon. The current setting is displayed on the right-hand side. The setting mode is opened with **<ENTER>**. Subsequently, the setting can be changed with **<▲ ><▼ >** and **<ENTER>**. Example:

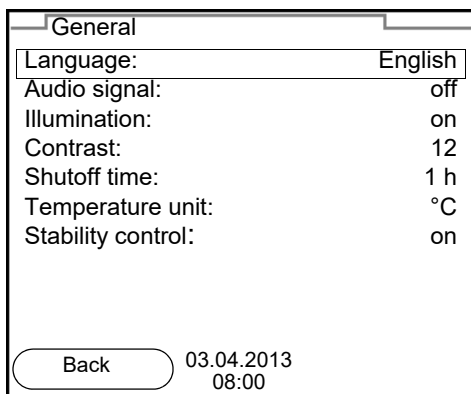

● **Functions**

Functions are designated by the name of the function. They are immediately carried out by confirming with **<ENTER>**. Example: Display the *Calibration record* function.

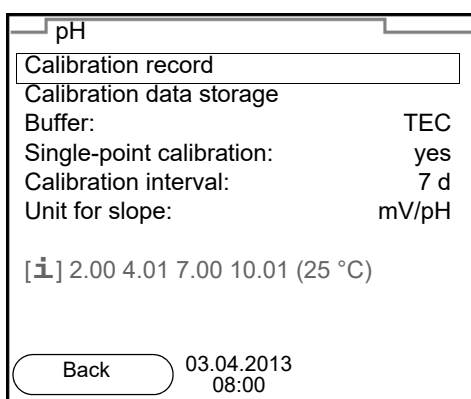

● **Messages**

Information is marked by the [i] symbol. It cannot be selected. Example:

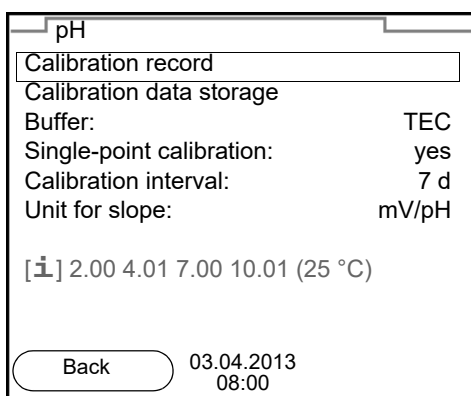

4.5.4 Example 1 on navigation: Setting the language

1. Press the **<On/Off>** key.
The measured value display appears.
The instrument is in the measuring mode.

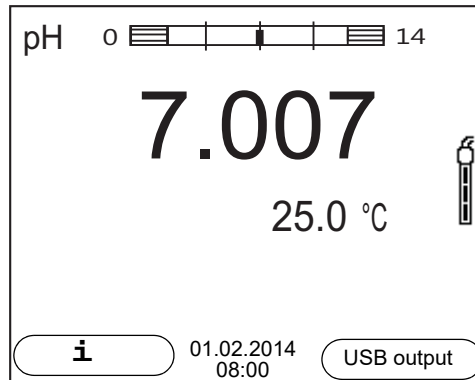

2. Using **<ENTER_ >**, open the *Storage & config* menu.
The instrument is in the setting mode.

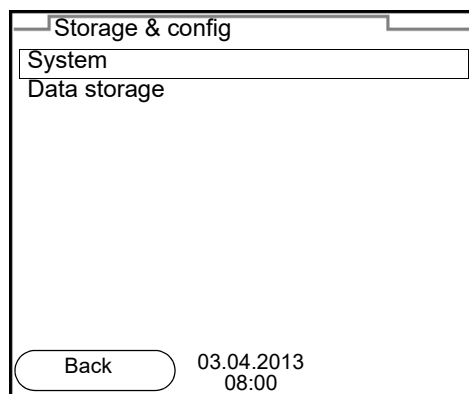

3. Select the *System* submenu with **<▲ ><▼ >**.
The current selection is displayed with a frame.
4. Open the *System* submenu with **<ENTER>**.

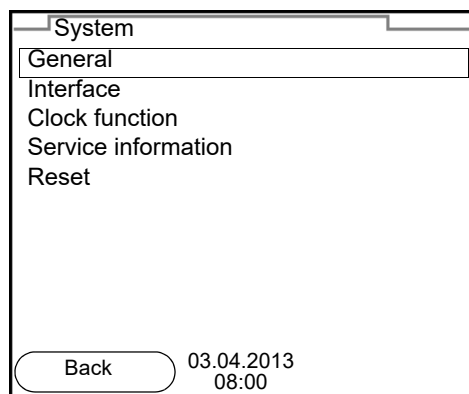

5. Select the *General* submenu with <▲ ><▼ >. The current selection is displayed with a frame.
6. Open the *General* submenu with <ENTER>.

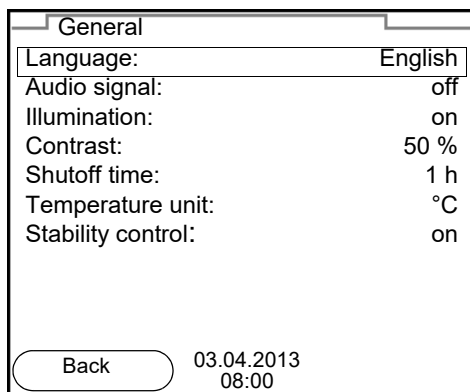

7. Open the setting mode for the *Language* with <ENTER>.

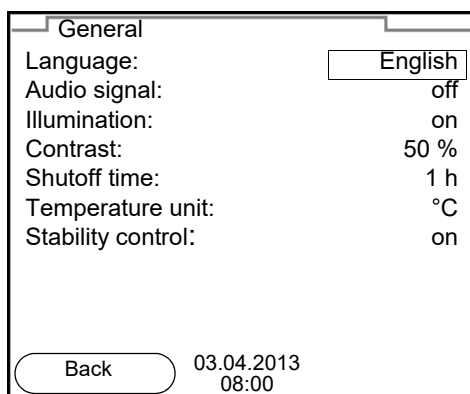

8. Select the required language with <▲ ><▼ >.
9. Confirm the setting with <ENTER>. The meter switches to the measuring mode. The selected language is active.

4.5.5 Example 2 on navigation: Setting the date and time

The meter has a clock with a date function. The date and time are indicated in the status line of the measured value display.

When storing measured values and calibrating, the current date and time are automatically stored as well.

The correct setting of the date and time and date format is important for the following functions and displays:

- Current date and time
- Calibration date
- Identification of stored measured values.

Therefore, check the time at regular intervals.



After a fall of the supply voltage (empty batteries), the date and time are reset.

Setting the date, time and date format

The date format can be switched from the display of day, month, year (*dd.mm.yy*) to the display of month, day, year (*mm/dd/yy* or *mm.dd.yy*).

1. In the measured value display:
Using **<ENTER_ >**, open the *Storage & config* menu.
The instrument is in the setting mode.
2. Select and confirm the *System / Clock function* menu with **<▲ ><▼ >** and **<ENTER>**.
The setting menu for the date and time opens up.

Clock function	
Date format:	dd.mm.yy
Date:	03.04.2013
Time:	14:53:40
<div style="display: flex; justify-content: space-between; align-items: center;"> Back 03.04.2013 08:00 </div>	

3. Select and confirm the *Time* menu with **<▲ ><▼ >** and **<ENTER>**.
The hours are highlighted.
4. Change and confirm the setting with **<▲ ><▼ >** and **<ENTER>**.
The minutes are highlighted.
5. Change and confirm the setting with **<▲ ><▼ >** and **<ENTER>**.
The seconds are highlighted.
6. Change and confirm the setting with **<▲ ><▼ >** and **<ENTER>**.
The time is set.
7. If necessary, set the *Date* and *Date format*. The setting is made similarly to that of the time.
8. To make further settings, switch to the next higher menu level with **<F1>/ [Back]**.
or
Switch to the measured value display with **<M>**.
The instrument is in the measuring mode.

5 pH value

5.1 Measuring

5.1.1 Measuring the pH value

NOTE

When connecting a grounded PC/printer, measurements cannot be performed in grounded media as the values would be incorrect. The USB interface is not galvanically isolated.

1. Connect the IDS pH sensor to the meter.
The pH measuring window is displayed.
2. If necessary, select the measured parameter with **<M>**.
3. Adjust the temperature of the solutions and measure the current temperature if the measurement is made without a temperature sensor.
4. If necessary, calibrate or check the IDS pH sensor.
5. Immerse the IDS pH sensor in the test sample.

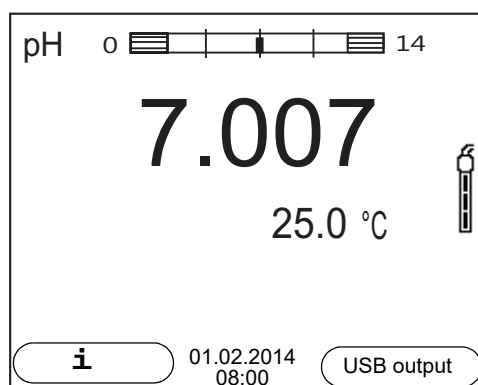

Stability control (AutoRead) & HOLD function

The stability control function (*AutoRead*) continually checks the stability of the measurement signal. The stability has a considerable impact on the reproducibility of measured values.

The measured parameter flashes on the display

- as soon as the measured value is outside the stability range
- when the automatic *Stability control* is switched off.

You can start the *Stability control* manually at any time, irrespective of the setting for automatic *Stability control* (see section 10.6.3 AUTOMATIC STABILITY CONTROL, page 77) in the *System* menu.

1. Freeze the measured value with **<AR>**.
The [HOLD] status indicator is displayed.
The HOLD function is active.



You can terminate the *Stability control* function and the HOLD function with **<AR>** or **<M>** at any time.

2. Using **<ENTER>**, activate the *Stability control* function manually. The [AR] status indicator appears while the measured value is assessed as not stable. A progress bar is displayed and the display of the measured parameter flashes. The [HOLD][AR] status indicator appears as soon as a stable measured value is recognized. The progress bar disappears and the display of the measured parameter stops flashing. The current measurement data is output to the interface. Measurement data meeting the stability control criterion is marked by AR.



You can prematurely terminate the *Stability control* function manually with **<ENTER>** at any time. If the *Stability control* function is prematurely terminated, the current measurement data are output to the interface without the AutoRead info.

3. Using **<ENTER>**, start a further measurement with stability control.
or
Release the frozen measured value again with **<AR>** or **<M>**.
The [AR] status display disappears. The display switches back to the previous indication.

Criteria for a stable measured value

The *Stability control* function checks whether the measured values are stable within the monitored time interval.

Measured parameter	Time interval	Stability in the time interval
pH value	15 seconds	Δ : Better than 0.01 pH
Temperature	15 seconds	Δ : Better than 0.5 °C

The minimum duration until a measured value is assessed as stable is the monitored time interval. The actual duration is mostly longer.

5.1.2 Measuring the temperature

For reproducible pH measurements, it is essential to measure the temperature of the test sample.

IDS sensors measure the temperature with a temperature sensor integrated in the IDS sensor.

When operating a sensor without integrated temperature sensor, e.g. via an IDS pH adapter, you have to measure and enter the temperature of the test sample first.

The display of the temperature indicates the active temperature measuring

mode:

Temperature sensor	Resolution of the temp. display	Temp. measurement
yes	0.1 °C	Automatic with temperature sensor
-	1 °C	Manual

5.2 pH calibration

5.2.1 Why calibrate?

pH electrodes age. This changes the zero point (asymmetry) and slope of the pH electrode. As a result, an inexact measured value is displayed. Calibration determines and stores the current values of the zero point and slope of the electrode.

Thus, you should calibrate at regular intervals.

5.2.2 When do you have to calibrate?

- Routinely within the framework of the company quality assurance
- When the calibration interval has expired

5.2.3 Carrying out automatic calibration (AutoCal)

Make sure that in the sensor menu, *Buffer* menu, the buffer set is correctly selected (see section 10.1.1 SETTINGS FOR PH MEASUREMENTS, page 67).

Use one to five buffer solutions of the selected buffer set in any order.

Below, calibration with Technical buffers (TEC) is described. When other buffer sets are used, other nominal buffer values are displayed. Apart from that, the procedure is identical.



If single-point calibration was set in the menu, the calibration procedure is automatically finished with the measurement of buffer solution 1 and the calibration record is displayed.

1. Connect the pH sensor to the meter.
The pH measuring window is displayed.
2. Keep the buffer solutions ready.
When measuring without temperature sensor:
Temper the buffer solutions or measure the current temperature.
3. Start the calibration with **<CAL>**.
The calibration display for the first buffer appears (voltage display).

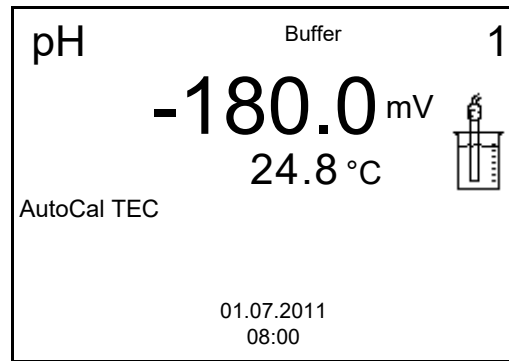

4. Thoroughly rinse the sensor with deionized water.
5. Immerse the sensor in the first buffer solution.
6. For measurements without temperature sensor (e.g. when using an IDS adapter): Measure the temperature of the buffer manually and enter it with $\langle \blacktriangle \rangle \langle \blacktriangledown \rangle$.
7. Start the measurement with $\langle \text{ENTER} \rangle$. The measured value is checked for stability (stability control). The [AR] status indicator is displayed. The measured parameter flashes.

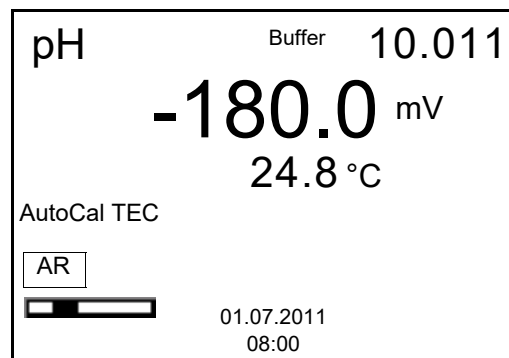

8. Wait for the end of the measurement with stability control or accept the calibration value with $\langle \text{ENTER} \rangle$. The calibration display for the next buffer appears (voltage display).
9. If necessary, finish the calibration procedure as a single-point calibration with $\langle \mathbf{M} \rangle$. The calibration record is displayed.



For **single-point calibration**, the instrument uses the Nernst slope (-59.2 mV/pH at 25 °C) and determines the zero point of the IDS pH sensor.

Continuing with two-point calibration

10. Thoroughly rinse the sensor with deionized water.
11. Immerse the pH sensor in buffer solution 2.

12. When measuring without temperature sensor:
Measure the temperature of the buffer manually and enter it with **<▲ ><▼ >**.
13. Start the measurement with **<ENTER>**.
The measured value is checked for stability (stability control).
The [AR] status indicator is displayed. The measured parameter flashes.

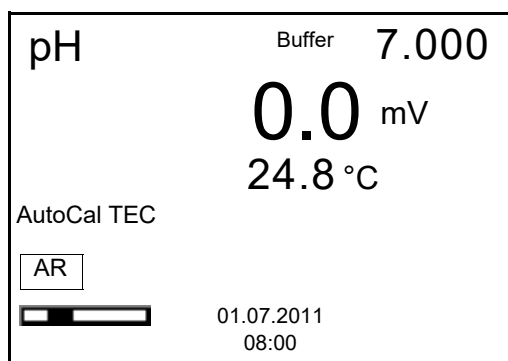

14. Wait for the measurement with stability control to be completed or terminate the stability control and take over the calibration value with **<ENTER>**.
The calibration display for the next buffer appears (voltage display).
15. If necessary, finish the calibration procedure as a two-point calibration with **<M>**.
The calibration record is displayed.

Continuing with three- to five-point calibration

16. Thoroughly rinse the sensor with deionized water.
17. Immerse the sensor in the next buffer solution.
18. When measuring without temperature sensor:
Measure the temperature of the buffer manually and enter it with **<▲ ><▼ >**.
19. Start the measurement with **<ENTER>**.
The measured value is checked for stability (stability control).
The [AR] status indicator is displayed. The measured parameter flashes.

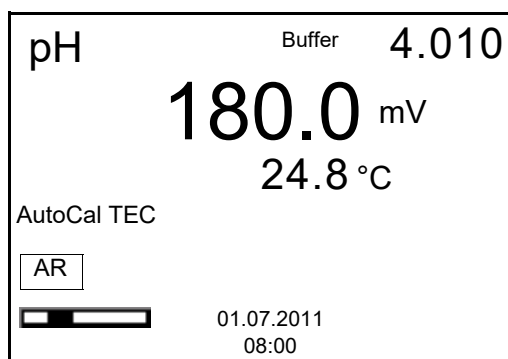

20. Wait for the measurement with stability control to be completed or terminate the stability control and take over the calibration value with **<ENTER>**.
The calibration display for the next buffer appears (voltage display).
21. If necessary, use **<M>** to finish the calibration.
The calibration record is displayed.
or
Switch to calibration with the next buffer with **<ENTER>**.



Calibration is automatically completed after the last buffer of a buffer set has been measured. Then the calibration record is displayed.

The calibration line is determined by linear regression.

5.2.4 Carrying out manual calibration (ConCal)

Make sure that in the sensor menu, *Buffer* menu, the *ConCal* buffer set is correctly selected (see section 10.1.1 SETTINGS FOR PH MEASUREMENTS, page 67).

Use one to five buffer solutions in any order. The pH values of the buffer solutions should differ by at least one pH unit.



If single-point calibration was set in the menu, the calibration procedure is automatically finished with the measurement of buffer solution 1 and the calibration record is displayed.

1. Connect the pH sensor to the meter.
The pH measuring window is displayed.
2. Keep the buffer solutions ready.
When measuring without temperature sensor:
Temper the buffer solutions or measure the current temperature.
3. Start the calibration with **<CAL>**.
The calibration display for the first buffer appears (voltage display).

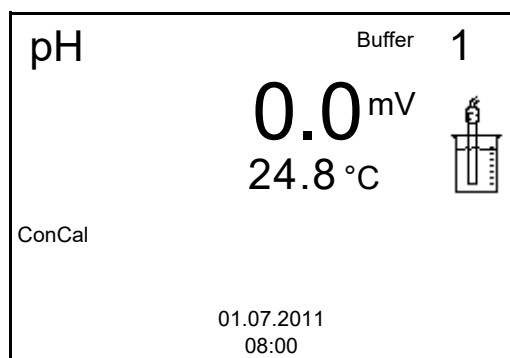

4. Thoroughly rinse the sensor with deionized water.
5. Immerse the pH sensor in buffer solution 1.
6. For measurements without temperature sensor (e.g. when using an IDS adapter):
Measure the temperature of the buffer manually and enter it with **<▲ ><▼ >**.
7. Start the measurement with **<ENTER>**.
The measured value is checked for stability (stability control).
The [AR] status indicator is displayed. The measured parameter flashes.

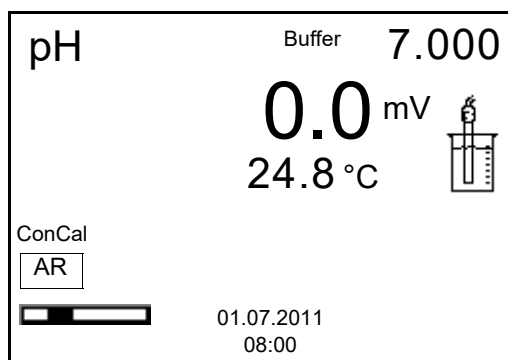

8. Wait for the measurement with stability control to be completed or terminate the stability control and take over the calibration value with **<ENTER>**.
The pH value of the buffer solution is displayed.

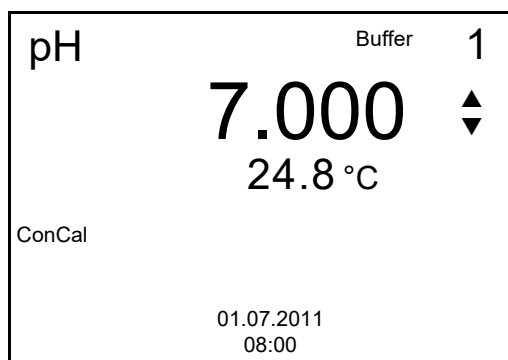

9. Set the nominal buffer value for the measured temperature with **<▲ ><▼ >**.
10. Accept the calibration value with **<ENTER>**.
The calibration display for the next buffer appears (voltage display).
11. If necessary, finish the calibration procedure as a single-point calibration with **<M>**.
The calibration record is displayed.



For **single-point calibration**, the instrument uses the Nernst slope (-59.2 mV/pH at 25 °C) and determines the zero point of the IDS pH sensor.

Continuing with two-point calibration

12. Thoroughly rinse the sensor with deionized water.
13. Immerse the pH sensor in buffer solution 2.
14. When measuring without temperature sensor:
Measure the temperature of the buffer manually and enter it with **<▲ ><▼ >**.
15. Start the measurement with **<ENTER>**.
The measured value is checked for stability (stability control).
The [AR] status indicator is displayed. The measured parameter flashes.
16. Wait for the measurement with stability control to be completed or terminate the stability control and take over the calibration value with **<ENTER>**.
The pH value of the buffer solution is displayed.

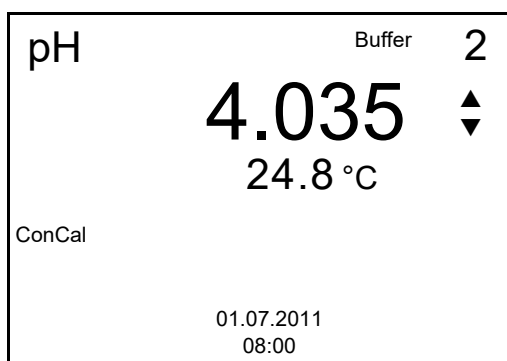

17. Set the nominal buffer value for the measured temperature with **<▲ ><▼ >**.
18. Accept the calibration value with **<ENTER>**.
The calibration display for the next buffer appears (voltage display).
19. If necessary, finish the calibration procedure as a two-point calibration with **<M>**.
The calibration record is displayed.

Continuing with three- to five-point calibration

20. Thoroughly rinse the sensor with deionized water.
21. Immerse the sensor in the next buffer solution.
22. When measuring without temperature sensor:
Measure the temperature of the buffer manually and enter it with **<▲ ><▼ >**.

23. Start the measurement with **<ENTER>**.
The measured value is checked for stability (stability control).
The [AR] status indicator is displayed. The measured parameter flashes.
24. Wait for the measurement with stability control to be completed or terminate the stability control and take over the calibration value with **<ENTER>**.
The pH value of the buffer solution is displayed.

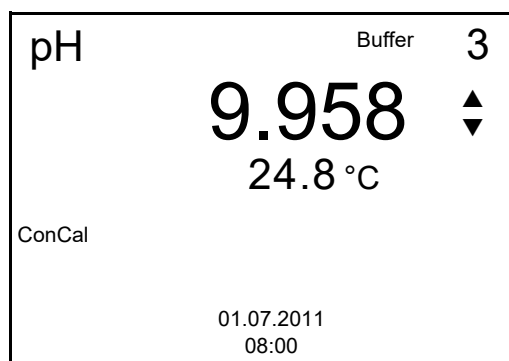

25. Set the nominal buffer value for the measured temperature with **<▲ ><▼ >**.
26. Accept the calibration value with **<ENTER>**.
The calibration display for the next buffer appears (voltage display).
27. If necessary, use **<M>** to finish the calibration.
The calibration record is displayed.
or
Continue calibrating using the next buffer with **<ENTER>**.



After the fifth buffer has been measured the calibration is automatically finished. Then the calibration record is displayed.

The calibration line is determined by linear regression.

5.2.5 Calibration points

Calibration can be performed using one to five buffer solutions in any order (single-point to five-point calibration). The meter determines the following values and calculates the calibration line as follows:

Calibration	Determined values	Displayed calibration data
1-point	<i>Asy</i>	<ul style="list-style-type: none"> ● Zero point = <i>Asy</i> ● Slope = Nernst slope (-59.2 mV/pH at 25 °C)
2-point	<i>Asy</i> <i>Slp.</i>	<ul style="list-style-type: none"> ● Zero point = <i>Asy</i> ● Slope = <i>Slp.</i>

Calibration	Determined values	Displayed calibration data
3-point to 5-point	<i>Asy</i> <i>Slp.</i>	<ul style="list-style-type: none"> ● Zero point = <i>Asy</i> ● Slope = <i>Slp.</i> <p>The calibration line is calculated by linear regression.</p>



You can display the slope in the units, mV/pH or % (see section 10.1.1 SETTINGS FOR PH MEASUREMENTS, page 67).

5.2.6 Calibration data



The calibration record is automatically transmitted to the interface after calibrating.

Displaying the calibration data





The calibration record of the last calibration is to be found under the menu item, *Calibration / Calibration record*. To open it in the measured value display, press the **<CAL__>** key.

The calibration records of the last 10 calibrations are to be found in the menu, *Calibration / Calibration data storage / Display*. To open the *Calibration* menu, press the **<ENTER>** key in the measured value display.

Menu item	Setting/function	Description
<i>Calibration / Calibration data storage / Display</i>	-	<p>Displays the calibration records.</p> <p>Further options:</p> <ul style="list-style-type: none"> ● Scroll through the calibration records with <▲ ><▼ >. ● Output the displayed calibration record to the interface with <F2>/[USB output]. ● Output all calibration records to the interface with <F2__>/[USB output]. ● Quit the display with <F1>/[Back] or <ENTER>. ● Switch directly to the measured value display with <M>.
<i>Calibration / Calibration data storage / Output to RS232/USB</i>	-	Outputs the calibration data storage to the interface

Calibration evaluation

After calibrating, the meter automatically evaluates the calibration. The zero point and slope are evaluated separately. The worse evaluation of both is taken into account. The evaluation appears on the display and in the calibration record.

Display	Calibration record	Zero point [mV]	Slope [mV/pH]
	+++	-15 ... +15	-60.5 ... -58.0
	++	-20 ... <-15 or >+15 ... +20	>-58.0 ... -57.0
	+	-25 ... <-20 or >+20 ... +25	-61.0 ... <-60.5 or >-57.0 ... -56.0
	-	-30 ... <-25 or >+25 ... +30	-62.0 ... <-61.0 or >-56.0 ... -50.0
Clean the IDS sensor according to the sensor operating manual			
<i>Error</i>	<i>Error</i>	<-30 or >+30	<-62.0 or >-50.0
Error elimination (see section 14 WHAT TO DO IF..., page 91)			



For pH IDS sensors you can optionally enable a more finely graded calibration evaluation (QSC) (see section 5.2.8 QSC FUNCTION (SENSOR QUALITY CONTROL), page 38).

Calibration record (USB output)

```
Multi 3510 IDS
Ser. no. 11292113

CALIBRATION pH
01.02.2014 15:55

Ser. no. 10501234
TECYSI
Buffer 1          4.01
Buffer 2          7.00
Buffer 3         10.01
Voltage 1         184.0 mV
Voltage 2          3.0 mV
Voltage 3        -177.0 mV
Temperatur 1      24.0 °C
Temperatur 2      24.0 °C
Temperatur 3      24.0 °C
Slope            -60.2 mV/pH
Asymmetry         4.0 mV
Sensor           +++

etc...
```

5.2.7 Continuous measurement control (CMC function)

The Continuous Measurement Control (CMC function) facilitates to evaluate the current measured value instantly and definitely.

After each successful calibration the scale of the pH measuring range is displayed in the measured value display. Here you can very clearly see whether or not the current measured value is in the calibrated part of the measuring range.

The following information is displayed:

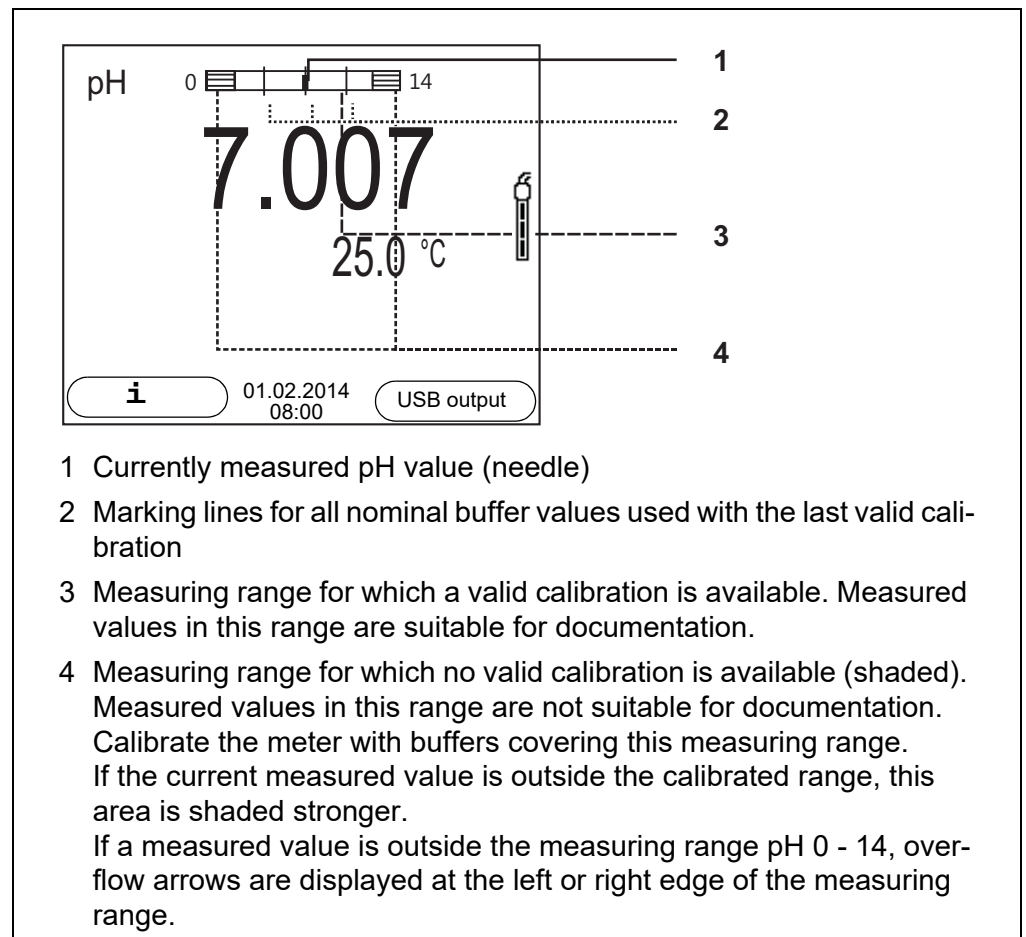

The limits of the calibrated range are determined by the buffers used for calibration:

Lower limit: Buffer with lowest pH value - 2 pH units
 Upper limit: Buffer with highest pH value + 2 pH units

5.2.8 QSC function (sensor quality control)

General information on the QSC function

The QSC function (Quality Sensor Control) is a new sensor evaluation for digital IDS sensors. It evaluates the condition of an IDS pH sensor individually and with a very fine grading.

The QSC scale shows the current sensor evaluation with an indicator on the display.

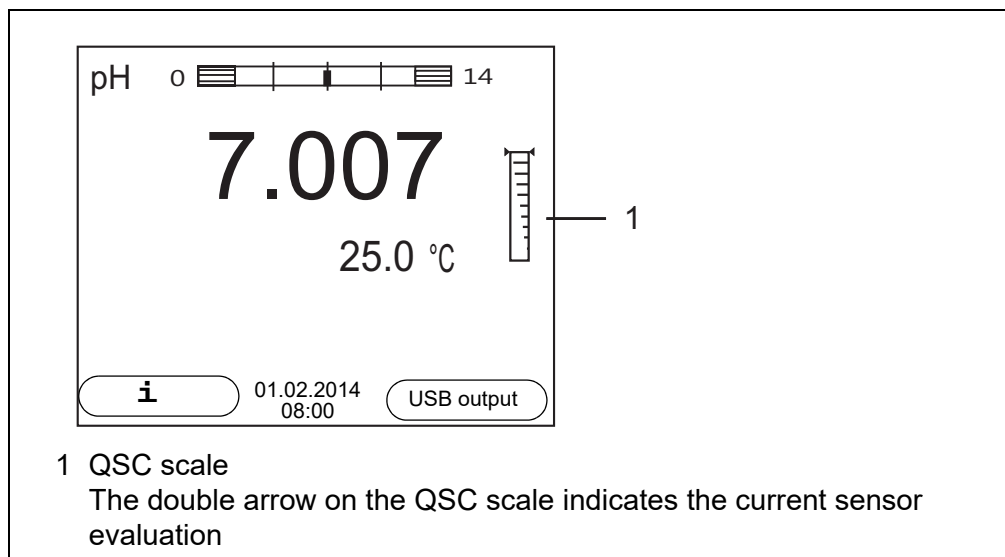

In the USB output the sensor evaluation is given as a percentage (1-100).

The finely graded sensor evaluation of the QSC function promptly calls your attention to changes of the sensor.

Thus you can do what is necessary to restore the optimum measuring quality (e.g. clean, calibrate or replace the sensor).

Sensor evaluation with / without QSC function

With QSC function	Without QSC function (sensor symbol)
Very fine grading of the sensor evaluation (100 grades)	Rough grading of the sensor evaluation (4 grades)
The reference value is individually determined for each sensor during the QSC initial calibration.	A theoretical reference value is used for all sensors
Low tolerances for zero point and slope when using QSC buffer solutions	Greater tolerances for zero point and slope when using commercial buffer sets
Additional QSC calibration required (with special QSC buffer set)	No additional calibration required

QSC calibration

The QSC function is enabled by once carrying out an additional three-point calibration with special QSC buffer solutions. It covers the measuring range of the sensor (pH 2 to pH 11). The QSC initial calibration determines the actual condition of the sensor and stores it as a reference in the sensor.

To meet the high requirements of a QSC initial calibration, the QSC initial calibration should optimally be carried out with the initial commissioning of the sensor.

Carry out the normal calibrations for your special measuring range with your usual standard solutions as previously done.



As soon as the QSC function was enabled for an IDS sensor, it is not possible to return to the sensor evaluation with the sensor symbol for this sensor.

Carrying out a QSC initial calibration

1. Open the menu for measurement settings with **<ENTER>**.
2. In the QSC menu, select *First calibration* with **<▲ ><▼ >**. The calibration display appears. *AutoCal QSC-Kit* is displayed as the buffer. Exclusively use the QSC-Kit for the QSC calibration. If you use other buffers, you will have no valid QSC calibration.

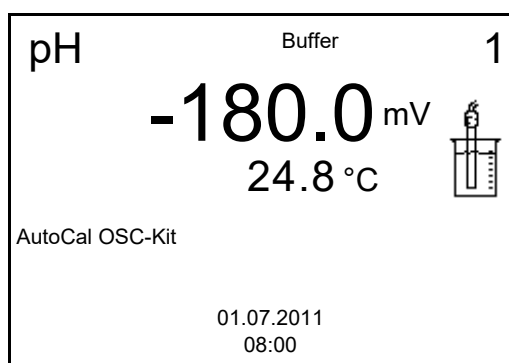

3. Calibration with the buffers of the QSC-Kit is done like a normal three-point calibration. Follow the user guide.



Carry out the QSC initial calibration very carefully. It determines the reference value for the sensor. This reference value cannot be overwritten or reset.

As soon as the QSC function was enabled, it is not possible to return to the sensor evaluation with the sensor symbol.

4. As soon as the three-point calibration has been successfully carried out you can decide whether to accept or discard the calibration as the QSC initial calibration.

The QSC initial calibration is completed. The sensor is calibrated. If you want to calibrate with special buffers for your measurements, you can subsequently carry out a normal calibration with your buffers. The reference values determined with the QSC calibration are also used for the evaluation of normal calibrations. In the measured value display, the QSC scale of the QSC function is always displayed. A double arrow on the QSC scale indicates the current sen-

sensor evaluation.

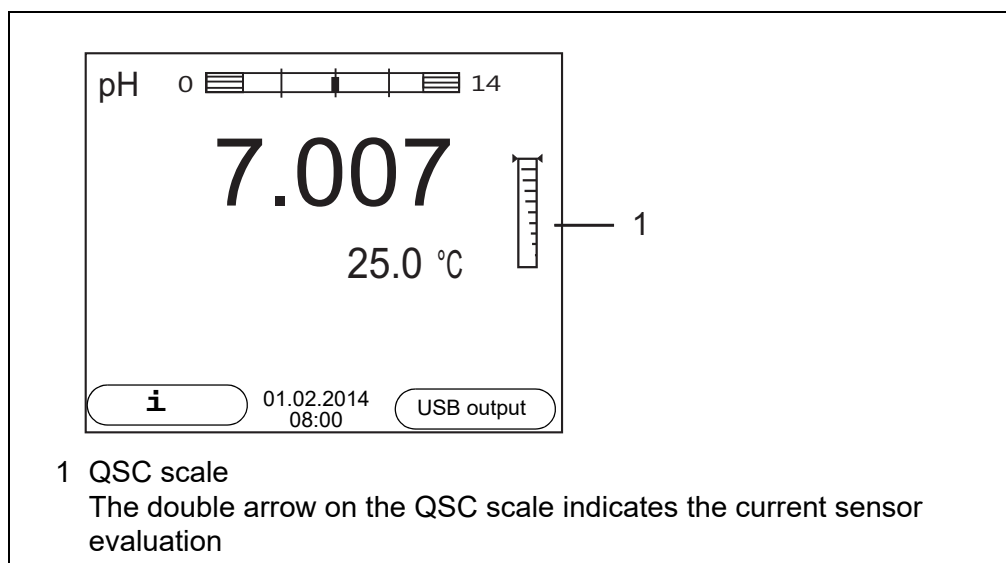

Carrying out a QSC control calibration

A QSC control calibration can, e.g. be useful if the sensor evaluation noticeably changed (after some normal calibrations).

You can carry out QSC control calibrations at greater intervals than normal calibrations.

1. Open the menu for measurement settings with **<ENTER>**.
2. In the QSC menu, select *Control calibration* with **<▲ ><▼ >**.
The calibration display appears. *AutoCal QSC-Kit* is displayed as the buffer.
Exclusively use the QSC-Kit for the QSC calibration. If you use other buffers, you will have no valid QSC control calibration.
3. Follow the user guide.
The calibration is carried out like a normal three-point calibration. As soon as the three-point calibration has been successfully carried out you can decide whether to accept or discard the calibration as the QSC control calibration.

6 ORP

6.1 Measuring

6.1.1 Measuring the ORP

NOTE

When connecting a grounded PC/printer, measurements cannot be performed in grounded media as the values would be incorrect. The USB interface is not galvanically isolated.



IDS ORP sensors are not calibrated. However, you can check IDS ORP sensors using a test solution.

1. Connect the ORP sensor to the meter.
The ORP measuring window is displayed.
2. Adjust the temperature of the solutions and measure the current temperature if the measurement is made without a temperature sensor.
3. Check the meter with the ORP sensor.
4. Immerse the ORP sensor in the test sample.

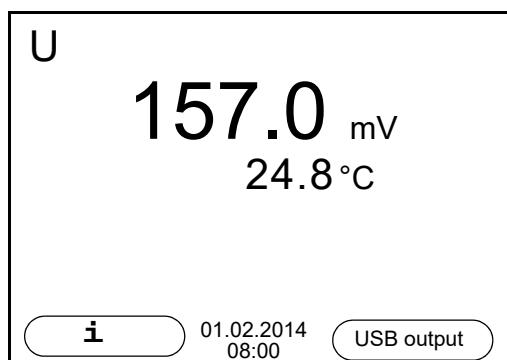

Stability control (AutoRead) & HOLD function

The stability control function (*AutoRead*) continually checks the stability of the measurement signal. The stability has a considerable impact on the reproducibility of measured values.

The measured parameter flashes on the display

- as soon as the measured value is outside the stability range
- when the automatic *Stability control* is switched off.

You can start the *Stability control* manually at any time, irrespective of the setting for automatic *Stability control* (see section 10.6.3 AUTOMATIC STABILITY CONTROL, page 77) in the *System* menu.

1. Freeze the measured value with **<AR>**.
The [HOLD] status indicator is displayed.
The HOLD function is active.



You can terminate the *Stability control* function and the HOLD function with **<AR>** or **<M>** at any time.

2. Using **<ENTER>**, activate the *Stability control* function manually. The [AR] status indicator appears while the measured value is assessed as not stable. A progress bar is displayed and the display of the measured parameter flashes. The [HOLD][AR] status indicator appears as soon as a stable measured value is recognized. The progress bar disappears and the display of the measured parameter stops flashing. The current measurement data is output to the interface. Measurement data meeting the stability control criterion is marked by AR.



You can prematurely terminate the *Stability control* function manually with **<ENTER>** at any time. If the *Stability control* function is prematurely terminated, the current measurement data are output to the interface without the AutoRead info.

3. Using **<ENTER>**, start a further measurement with stability control.
or
Release the frozen measured value again with **<AR>** or **<M>**. The [AR] status display disappears. The display switches back to the previous indication.

Criteria for a stable measured value

The *Stability control* function checks whether the measured values are stable within the monitored time interval.

Measured parameter	Time interval	Stability in the time interval
ORP	15 seconds	Δ : Better than 0.3 mV
Temperature	15 seconds	Δ : Better than 0.5 °C

The minimum duration until a measured value is assessed as stable is the monitored time interval. The actual duration is mostly longer.

6.1.2 Measuring the temperature

For reproducible ORP measurements, it is essential to measure the temperature of the test sample.

When operating a sensor without integrated temperature sensor, you first have to measure and enter the temperature of the sample.

The measuring instrument recognizes whether a suitable sensor is connected and automatically switches on the temperature measurement.

The display of the temperature indicates the active temperature measuring mode:

Temperature sensor	Resolution of the temp. display	Temp. measurement
yes	0.1 °C	Automatic with temperature sensor
-	1 °C	Manual

6.2 ORP calibration



ORP electrodes are not calibrated. You can, however, check ORP electrodes by measuring the ORP of a test solution and comparing the value with the nominal value.

7 Dissolved oxygen

7.1 Measuring

7.1.1 Measuring D.O.

1. Connect the IDS D.O. sensor to the meter.
The D.O. measuring screen is displayed.
2. If necessary, select the measured parameter with **<M>**.
3. Check or calibrate the meter with the sensor.



Only in special cases does the FDO[®] 925 D.O. sensor require calibration. A regular FDO[®] Check is sufficient.

4. Immerse the IDS D.O. sensor in the test sample.

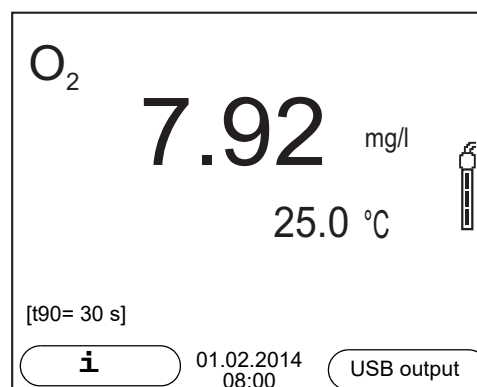

Selecting the displayed measured parameter

You can switch between the following displays with **<M>**:

- D.O. concentration [mg/l]
- D.O. saturation [%]
- D.O. partial pressure [mbar].

Salinity correction

When measuring the D.O. concentration [mg/l] of solutions with a salt content of more than 1 g/l, a salinity correction is required. For this, you have to measure and input the salinity of the measured medium first.

When the salinity correction is switched on, the [Sal] indicator is displayed in the measuring screen.



You can switch the salinity correction on or off and enter the salinity in the menu for calibration and measurement settings (see section 10.3.1 SETTINGS FOR D.O. SENSORS (MENU FOR MEASUREMENT AND CALIBRATION SETTINGS), page 71).

Air pressure correction

The integrated air pressure sensor of the Multi 3510 IDS measures the current air pressure. The air pressure is automatically used for air pressure correction during calibrating and for the display of the oxygen saturation [%] parameter.

current air pressure when an IDS D.O. sensor is connected. You can view the current air pressure in the sensor menu when an IDS D.O. sensor is connected. Press the **<ENTER>** key in the measured value display. The current air pressure is displayed as an info message.

Stability control (AutoRead) & HOLD function

The stability control function (*AutoRead*) continually checks the stability of the measurement signal. The stability has a considerable impact on the reproducibility of measured values.

The measured parameter flashes on the display

- as soon as the measured value is outside the stability range
- when the automatic *Stability control* is switched off.

Irrespective of the setting for automatic *Stability control* (see section 10.6.3 AUTOMATIC STABILITY CONTROL, page 77) in the *System* menu, you can start a measurement with *Stability control* manually at any time.

1. Freeze the measured value with **<AR>**.
The [HOLD] status indicator is displayed.
The HOLD function is active.



You can terminate the *Stability control* function and the HOLD function with **<AR>** or **<M>** at any time.

2. Using **<ENTER>**, activate the *Stability control* function manually. The [AR] status indicator appears while the measured value is assessed as not stable. A progress bar is displayed and the display of the measured parameter flashes. The [HOLD][AR] status indicator appears as soon as a stable measured value is recognized. The progress bar disappears and the display of the measured parameter stops flashing. The current measurement data is output to the interface. Measurement data meeting the stability control criterion is marked by AR.



You can prematurely terminate the *Stability control* function manually with **<ENTER>** at any time. If the *Stability control* function is prematurely terminated, the current measurement data are output to the interface without the AutoRead info.

3. Using **<ENTER>**, start a further measurement with stability control.
or
Release the frozen measured value again with **<AR>** or **<M>**.
The [AR] status display disappears. The display switches back to the previous indication.

Criteria for a stable measured value

The *Stability control* function checks whether the measured values are stable within the monitored time interval.

Measured parameter	Time interval	Stability in the time interval
D.O. concentration	20 seconds	Δ : better than 0.03 mg/l
D.O. saturation	20 seconds	Δ : better than 0.4 %
D.O. partial pressure	20 seconds	Δ : Better than 0.8 mbar
Temperature	15 seconds	Δ : Better than 0.5 °C

The minimum duration until a measured value is assessed as stable is the monitored time interval. The actual duration is mostly longer.

7.1.2 Measuring the temperature

For reproducible D.O. measurements, it is essential to measure the temperature of the test sample.

IDS D.O. sensors measure the temperature with a temperature sensor integrated in the IDS sensor.

7.2 FDO[®] Check procedure

7.2.1 Why should you check the sensor?

With the FDO[®] Check procedure, you can find out in a simple manner whether the FDO[®] 925 D.O. sensor should be cleaned or calibrated.

7.2.2 When should you check the sensor?

Checking can be useful in the following cases:

- When the check interval has expired (The [check] status indicator is displayed.)
- If the measured values seem to be implausible
- If you assume that the sensor cap is contaminated or at the end of its lifetime
- After the sensor cap was exchanged
- Routinely within the framework of the company quality assurance

7.2.3 Carrying out the FDO[®] Check procedure

FDO[®] Check procedure

Check in water vapor-saturated air.

Use the check and storage beaker (FDO[®] Check) to carry out the FDO[®] Check procedure.

Stability control (AutoRead)

In the FDO[®] Check procedure, the Stability control function (AutoRead) is automatically activated.

Proceed as follows to carry out the FDO[®] Check procedure:

1. Connect the D.O. sensor to the meter.
2. Place the D.O. sensor in the check and storage beaker, FDO[®] Check.



The sponge in the check and storage beaker must be moist (not wet). Leave the sensor in the check and storage beaker long enough so it can adapt to the ambient temperature.

3. Start the FDO[®] Check procedure in the measuring menu with *FDO Check / Start FDO Check*.
The meter switches to the measured parameter, %.

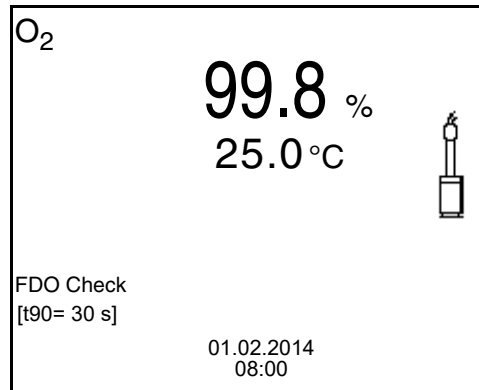

4. Start the measurement with **<ENTER>**.
The measured value is checked for stability (stability control).
The [AR] status indicator is displayed. The measured parameter flashes.
5. Wait for the end of the AutoRead measurement ([HOLD][AR]) status indicator or
take over the measured value with **<ENTER>**.
The measured value is frozen.
6. Switch to the measured value display with **<M>**.
The check measurement is not documented.

7.2.4 Evaluation

The evaluation is based on the accuracy required by the used. Together with the nominal value (100 %) this results in a validity scope for the check.

If the measured value is within the validity scope, no cleaning or user calibration is required.

If the measured value is outside the validity scope, the sensor shaft and membrane should be cleaned, and the check should then be repeated (see section 5.4.1).

Example:

- Required accuracy: ± 2 %.
- In water vapor-saturated air or air-saturated water, the nominal value for the relative D.O. saturation (abbreviated: saturation) is 100 %.
- Therefore, the validity scope is 98 ... 102 %
- The check resulted in a measured value of 99.3 %

The measurement error is within the specified validity scope.
No cleaning or user calibration is required.

7.3 Calibration

7.3.1 Why calibrate?

D.O. sensors age. This changes the slope of the D.O. sensor. Calibration determines the current slope of the sensor and stores this value in the instrument.



The FDO[®] 925 D.O. sensor ages so little it does not have to be regularly calibrated.

To detect changes of the sensor as early as possible, the FDO[®] Check procedure can be useful (see section 7.2 FDO[®] CHECK PROCEDURE, page 47).

7.3.2 When to calibrate?

- If your evaluation of the FDO[®] Check procedure suggests the necessity of a calibration
- When the calibration interval has expired
- When your accuracy requirements are especially high
- Routinely within the framework of the company quality assurance

7.3.3 Calibration procedures

The Multi 3510 IDS provides 2 calibration procedures:

- Calibration in water vapor-saturated air.
Use an OxiCal[®] air calibration vessel for calibration.
- Calibration via a comparison measurement (e.g. Winkler titration according to DIN EN 25813 or ISO 5813). At the same time, the relative slope is adapted to the comparison measurement by a correction factor. When the correction factor is active, the [*Factor*] indicator appears in the measuring screen.

7.3.4 Calibration in water vapor-saturated air

Use the check and storage beaker (FDO[®] Check) to calibrate the FDO[®] 925 sensor.

Proceed as follows to calibrate the D.O. sensor:

1. Connect the D.O. sensor to the meter.
2. Place the FDO[®] 925 D.O. sensor in the check and storage beaker, FDO[®] Check.



The sponge in the check and storage beaker must be moist (not wet). Leave the sensor in the check and storage beaker long enough so it can adapt to the ambient temperature.

3. Start the calibration with **<CAL>**.
The last calibration data (relative slope) is displayed.

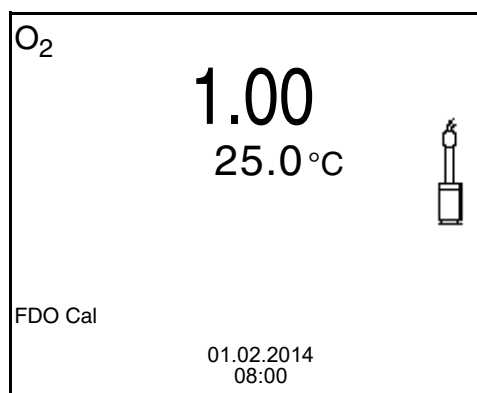

4. Start the measurement with **<ENTER>**.
The measured value is checked for stability (stability control).
The [AR] status indicator is displayed. The measured parameter flashes.
5. Wait for the end of the AutoRead measurement ([HOLD][AR]) status indicator.
The calibration record is displayed and output to the interface.
6. Switch to the measured value display with **<ENTER>**.

7.3.5 Calibration by means of a *Comparison meas.* (FDO Comp)

For this calibration procedure, the *Comparison meas.* setting must be set to *on* in the *Calibration* menu.



Before calibrating via a comparison measurement, the sensor should be calibrated in the air calibration vessel.

Proceed as follows to calibrate the instrument:

1. Connect the D.O. sensor to the measuring instrument.
2. Immerse the D.O. sensor in the reference solution.
3. Start the calibration with **<CAL>**.

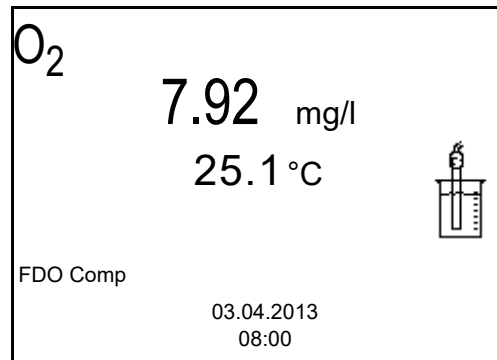

4. Start the measurement with **<ENTER>**.
The measured value is checked for stability (stability control).
The [AR] status indicator is displayed. The measured parameter flashes.
5. Wait for the end of the AutoRead measurement or accept the calibration value with **<ENTER>**.
The factor that was set last is displayed.

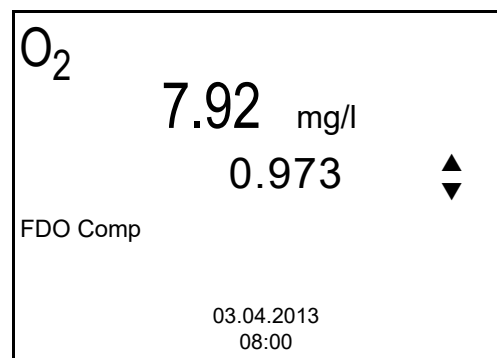

6. Using **<▲ >** **<▼ >**, set the correction factor to adjust the displayed concentration value to the nominal value (value of the comparison measurement). Subsequently, accept the correction factor with **<ENTER>**.
The measuring instrument switches to the measured value display.
The status display [*Factor*] is active.

7.3.6 Calibration data



The calibration record is automatically transmitted to the interface after calibrating.

Displaying the calibration record

The calibration record of the last calibration is to be found under the menu item, *Calibration / Calibration record*. To open it in the measured value display, press the **<CAL__>** key.



The calibration records of the last 10 calibrations are to be found in the menu, *Calibration/Calibration data storage / Display*. To open the *Calibration* menu, press the **<ENTER>** key in the measured value display.

Menu item	Setting/function	Description
<i>Calibration / Calibration data storage / Display</i>	-	Displays the calibration records. Further options: <ul style="list-style-type: none"> ● Scroll through the calibration records with <▲ ><▼ >. ● Output the displayed calibration record to the interface with <F2>/[USB output]. ● Output all calibration records to the interface with <F2_>/[USB output]. ● Quit the display with <F1>/[Back] or <ENTER>. ● Switch directly to the measured value display with <M>.
<i>Calibration / Calibration data storage / Output to RS232/USB</i>	-	Outputs the calibration data storage to the interface

Calibration evaluation

After the calibration, the meter automatically evaluates the current status of the calibration. The evaluation appears on the display and in the calibration record.

FDO® 925 calibration evaluation

Display	Calibration record	Relative slope
	+++	S = 0.94 ... 1.06
	++	S = 0.92 ... 0.94 or S = 1.06 ... 1.08
	+	S = 0.90 ... 0.92 or S = 1.08 ... 1.10
<i>Error</i>	<i>Error</i>	S < 0.90 or S > 1.10
Error elimination (see section 14 WHAT TO DO IF..., page 91)		

**Calibration record
(USB output)**

```
CALIBRATION Ox  
03.04.2013 07:43:33  
  
FDO 925  
Ser. no. 10146858  
  
SC-FDO 925 10158765  
Relative slope 0.98  
Sensor +++
```

8 Conductivity

8.1 Measuring

8.1.1 Measuring the conductivity

NOTE

When connecting a grounded PC/printer, measurements cannot be performed in grounded media as the values would be incorrect. The USB interface is not galvanically isolated.

1. Connect the conductivity sensor to the meter.
The conductivity measuring window is displayed.
The measuring cell and cell constant for the connected IDS conductivity sensor are automatically taken over.
2. If necessary, select the measured parameter χ with **<M>**.
3. Immerse the conductivity sensor in the test sample.

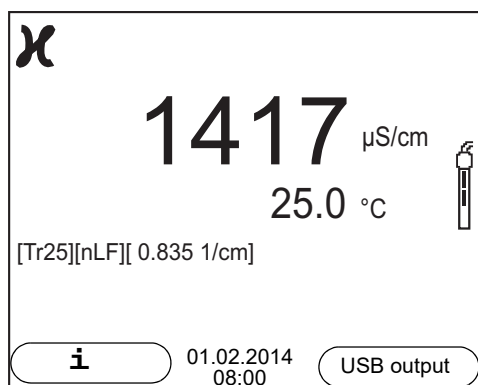

Selecting the displayed measured parameter

You can switch between the following displays with **<M>**:

- Conductivity [$\mu\text{S}/\text{cm}$] / [mS/cm]
- Resistivity [$\Omega\cdot\text{cm}$] / [$\text{k}\Omega\cdot\text{cm}$] / [$\text{M}\Omega\cdot\text{cm}$]
- Salinity SaL []
- Total dissolved solids TDS [mg/l] / [g/l]

The multiplier to calculate the total dissolved solids is set to 1.00 in the factory. You can adjust this multiplier to meet your requirements in the range 0.40 ... 1.00. The multiplier is set in the menu for the parameter, TDS.

Stability control (AutoRead) & HOLD function

The stability control function (*AutoRead*) continually checks the stability of the measurement signal. The stability has a considerable impact on the reproducibility of measured values.

The measured parameter flashes on the display

- as soon as the measured value is outside the stability range
- when the automatic *Stability control* is switched off.

You can start the *Stability control* manually at any time, irrespective of the set-

ting for automatic *Stability control* (see section 10.6.3 AUTOMATIC STABILITY CONTROL, page 77) in the *System* menu.

1. Freeze the measured value with **<AR>**.
The [HOLD] status indicator is displayed.
The HOLD function is active.



You can terminate the *Stability control* function and the HOLD function with **<AR>** or **<M>** at any time.

2. Using **<ENTER>**, activate the *Stability control* function manually.
The [AR] status indicator appears while the measured value is assessed as not stable. A progress bar is displayed and the display of the measured parameter flashes.
The [HOLD][AR] status indicator appears as soon as a stable measured value is recognized. The progress bar disappears and the display of the measured parameter stops flashing.
The current measurement data is output to the interface. Measurement data meeting the stability control criterion is marked by AR.



You can prematurely terminate the *Stability control* function manually with **<ENTER>** at any time. If the *Stability control* function is prematurely terminated, the current measurement data are output to the interface without the AutoRead info.

3. Using **<ENTER>**, start a further measurement with stability control.
or
Release the frozen measured value again with **<AR>** or **<M>**.
The [AR] status display disappears. The display switches back to the previous indication.

Criteria for a stable measured value

The *Stability control* function checks whether the measured values are stable within the monitored time interval.

Measured parameter	Time interval	Stability in the time interval
Conductivity χ	10 seconds	$\Delta \chi$: better than 1.0% of measured value
Temperature	15 seconds	Δ : Better than 0.5 °C

The minimum duration until a measured value is assessed as stable is the monitored time interval. The actual duration is mostly longer.

8.1.2 Measuring the temperature

For reproducible conductivity measurements, it is essential to measure the

temperature of the test sample.

IDS sensors measure the temperature with a temperature sensor integrated in the IDS sensor.

8.2 Temperature compensation

The calculation of the temperature compensation is based on the preset reference temperature, 20 °C or 25 °C. It appears on the display as *Tr20* or *Tr25*.

You can select one of the following temperature compensation methods:

- **Nonlinear temperature compensation (*nLF*)** according to EN 27 888
- **Linear temperature compensation (*Lin*)** with adjustable coefficients of 0.000 ... 3.000 %/K
- **No temperature compensation (off)**



The reference temperature and temperature compensation are set in the menu for the parameter, conductivity (see section 10.4.1 SETTINGS FOR IDS CONDUCTIVITY SENSORS, page 73).

Application tips

Select the following temperature compensations given in the table according to the respective test sample:

Test sample	Temperature compensation	Display
Natural water (ground water, surface water, drinking water)	<i>nLF</i> according to EN 27 888	<i>nLF</i>
Ultrapure water	<i>nLF</i> according to EN 27 888	<i>nLF</i>
Other aqueous solutions	<i>Lin</i> Set linear temperature coefficient 0.000 ... 10.000 %/K	<i>Lin</i>
Salinity (seawater)	Automatic <i>nLF</i> according to IOT (International Oceanographic Tables)	<i>Sal, nLF</i>

8.3 Calibration

8.3.1 Why calibrate?

Aging slightly changes the cell constant, e. g. due to coatings. As a result, an inexact measured value is displayed. The original characteristics of the cell can often be restored by cleaning the cell. Calibration determines the current value of the cell constant and stores this value in the meter. Thus, you should calibrate at regular intervals.

8.3.2 When to calibrate?

- After connecting a sensor
- Routinely within the framework of the company quality assurance
- When the cleaning interval has expired

8.3.3 Determining the cell constant (calibration in control standard)

You can determine the actual cell constant of the IDS conductivity sensor by calibrating with the control standard in the following range:
 $0.450 \text{ cm}^{-1} \dots 0.500 \text{ cm}^{-1}$ (e.g. TetraCon 925, nominal cell constant 0.475 cm^{-1})

The cell constant is determined in the control standard, 0.01 mol/l KCl.

In the delivery condition, the calibrated cell constant of the IDS sensor is set to 0.475 cm^{-1} (conductivity measuring cell, TetraCon 925).

For this calibration procedure, the *Type* setting must be set to *cal*. Proceed as follows to determine the cell constant:

1. Connect the conductivity sensor to the meter.
2. In the measured value display, select the conductivity parameter with **<M>**.
3. Start the calibration with **<CAL>**.
The cell constant that was calibrated last is displayed.

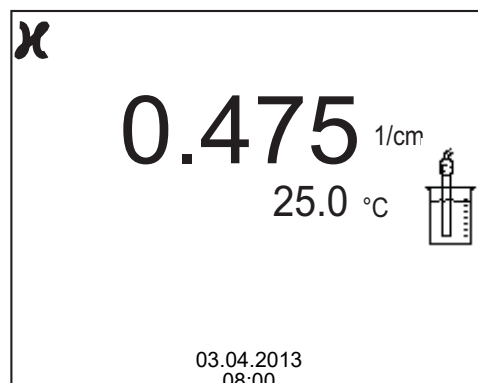

4. Immerse the conductivity sensor in the control standard solution, 0.01 mol/l KCl.
5. Start the measurement with **<ENTER>**.
The measured value is checked for stability (stability control).
The [AR] status indicator is displayed. The measured parameter flashes.
6. Wait for the end of the measurement with stability control ([HOLD][AR]) status indicator or
take over the calibrated value with **<ENTER>**.
The calibration record is displayed and output to the interface.
7. Switch to the measured value display with **<ENTER>**.

8.3.4 Calibration data



The calibration record is automatically transmitted to the interface after calibrating.

Displaying the calibration record

The calibration data can be displayed and then output to the interface.

The calibration record of the last calibration is to be found under the menu item, *Calibration / Calibration record*. To open it in the measured value display, press the **<CAL__>** key.

The calibration records of the last 10 calibrations are to be found in the menu, *Calibration / Calibration data storage / Display*. To open the *Calibration* menu, press the **<ENTER>** key in the measured value display.

Menu item	Setting/function	Description
<i>Calibration / Calibration data storage / Display</i>	-	<p>Displays the calibration records.</p> <p>Further options:</p> <ul style="list-style-type: none"> ● Scroll through the calibration records with <▲ ><▼ >. ● Output the displayed calibration record to the interface with <F2>/[USB output]. ● Output all calibration records to the interface with <F2__>[USB output]. ● Quit the display with <F1>/[Back] or <ENTER>. ● Switch directly to the measured value display with <M>.

Menu item	Setting/ function	Description
<i>Calibration / Calibration data storage / Output to RS232/USB</i>	-	Outputs the calibration data storage to the interface

Calibration evaluation

After calibration, the meter automatically evaluates the current status of the calibration. The evaluation appears on the display and in the calibration record.

Display	Calibration record	Cell constant [cm^{-1}]
	+++	Within the range 0.450 ... 0.500 cm^{-1}
<i>Error</i> Error elimination (see section 14 WHAT TO DO IF..., page 91)	<i>Error</i>	Outside the range 0.450 ... 0.500 cm^{-1}

Calibration record (USB output)

```

CALIBRATION Cond
03.04.2013 07:43:33

TetraCon 925
Ser. no. 09250033
Cell constant 0.476 1/cm      25.0 °C
Sensor                        +++

```

9 Turbidity measurement (VisoTurb® 900-P)

9.1 Measuring

9.1.1 Measuring the turbidity



The sensor connection and the USB-B (device) interface are galvanically insulated. This facilitates interference-free measurements also in the following cases:

- Measurement in grounded test samples
- Measurement with several sensors connected to one Multi 3510 IDS in one test sample

Preparatory activities

Perform the following preparatory activities when you want to measure:

- Avoid gas bubbles (e.g. air bubbles) in the test sample.
- Use suitable vessels for measurement and calibration (see operating manual of the VisoTurb® 900-P sensor).
- Heed the minimum depth of immersion for the sensor

- 1 Connect a turbidity sensor to the measuring instrument. The turbidity measuring screen is displayed. The data for the connected IDS turbidity sensor are automatically taken over.
- 2 Fill the test sample into a lightproof measuring beaker up to a level of at least 6 cm.
- 3 When immersing the sensor in the test sample, hold the sensor at an angle.
- 4 For measuring, position the sensor upright.
- 5 Position the sensor in a way that meets the following requirements.
 - Distance to the bottom: 6 cm
 - Distance to the walls of the beaker: 2 cm
 - Minimum depth of immersion: 2 cm



To position the sensor optimally and permanently while it is measuring, fix it on a support.

Measuring

You can carry out turbidity measurements as follows:

- 1 Perform the preparatory activities.

- 2 Immerse the sensor in the test sample at an angle and then position it in the measuring container.

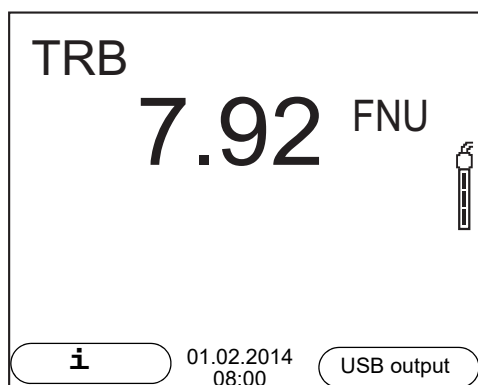

Selecting the displayed measured parameter

You can switch between the following displays with **<M>**:

- Turbidity [FNU]
- Turbidity [NTU]

Freezes the measured value (HOLD function)

With the HOLD function, you can freeze the current measured value. The displayed measured value stops changing until you switch the HOLD function off.

- 1 Freeze the measured value with **<AR>**.
The [HOLD] status indicator is displayed.



If the HOLD function is active, you can, e.g. start a manual measurement with stability control.

- 2 Release the frozen measured value again with **<AR>**.
The HOLD function is switched off.
The [HOLD] status display disappears.

Stability control (AutoRead)

The stability control function (*AutoRead*) continually checks the stability of the measurement signal. The stability has a considerable impact on the reproducibility of measured values. The display of the measured parameter flashes until a stable measured value is available.

You can start the *Stability control* function manually at any time, irrespective of the setting for automatic *Stability control* (see section 10.6.3 AUTOMATIC STABILITY CONTROL, page 77) in the *System* menu.

- 1 Freeze the measured value with **<AR>**.
The [HOLD] status indicator is displayed.

- 2 Using **<ENTER>**, activate the *Stability control* function manually. The [AR] status indicator appears while the measured value is assessed as not stable. A progress bar is displayed and the display of the measured parameter flashes. The [HOLD][AR] status indicator appears as soon as a stable measured value is recognized. The progress bar disappears and the display of the measured parameter stops flashing. The current measurement data is output to the interface. Measurement data meeting the stability control criterion is marked by AR.



You can prematurely terminate the *Stability control* function manually with **<ENTER>** at any time. If the *Stability control* function is prematurely terminated, the current measurement data are output to the interface without the AutoRead info.

- 3 Using **<ENTER>**, start a further measurement with *Stability control*.
or
Release the frozen measured value again with **<AR>**.
The display switches to the measured value display.
The [AR][HOLD] status display disappears.

Criteria for a stable measured value

The *Stability control* function checks whether the measured values are stable within the monitored time interval.

Measured parameter	Time interval	Stability in the time interval
Turbidity (FNU/NTU)	15 seconds	Δ : better than 1.0% of measured value

The minimum duration until a measured value is assessed as stable is the monitored time interval. The actual duration is mostly longer.

9.2 Calibration

9.2.1 Why calibrate?

The calibration line of the sensor is determined and stored through calibrating.

9.2.2 When to calibrate?

- When the calibration interval has expired
- At regular intervals

9.2.3 Calibration standards

Calibrate with 1 to 3 turbidity standard solutions. The standard solutions must be selected in the following order.

Standard solution	Range (FNU/NTU)
1	0.0 ... 1.0
2	5.0 ... 200.0
3	200.0 ... 4000.0

The turbidity expected in the measurement dictates the number and selection of the standards. Calibration has to be carried out for the range with the highest turbidity to be expected and for all lower ranges. The standard solutions for this have to be selected in ascending order, starting with standard 1.

Example: If you expect turbidity values in the range 200 ... 4000 FNU/NTU, you have to carry out a 3-point calibration.

The measurement precision is also dependent on the selected standard solutions. Therefore, the selected standard solutions should cover the value range expected of the turbidity measurement.

If the measured turbidity is outside the measurement range, OFL is displayed.



As the standard with turbidity value 0.0 FNU you can use clean tap water or filtered, deionized water in a suitable calibration vessel, depending on the required quality (see operating manual of the sensor VisoTurb® 900-P). This standard should be freshly prepared prior to every calibration. Suitable bottles are listed in the price list of the WTW catalog "Lab and field instrumentation".

Standards with turbidity values for the calibration ranges 2 and 3 are available as accessories (see price list of the WTW catalog "Lab and field instrumentation"). Calibration can be carried out in the bottles the standards are delivered in. The standards can be used several times within their shelf life.

Replace the standards solutions if you have any doubts concerning their quality or after the expiration date.

9.2.4 Carry out calibration

- 1 Perform the preparatory activities.
- 2 Connect the turbidity sensor to the measuring instrument. The turbidity measuring screen is displayed.
- 3 Keep the standard solutions ready in suitable calibration vessels.
- 4 In the measured value display, select the TRB measuring window with **<▲ >** **<▼ >** and **<M>**.

- 5 Start the calibration with **<CAL>**.
The calibration display appears.



- 6 Thoroughly rinse the turbidity sensor with distilled water and dry it with a lint-free cloth.
- 7 Immerse the turbidity sensor in the test sample at an angle.
- 8 Position the turbidity sensor in the measuring vessel.
- 9 Use **<▲ >** **<▼ >** and **<F2>/[▶]** to set the concentration of the standard solution for each digit and confirm with **<ENTER>**.
The standard solution is measured.
The measured value is checked for stability (AutoRead).
- 10 Wait for the end of the AutoRead measurement.
The calibration display for the next standard solution appears.

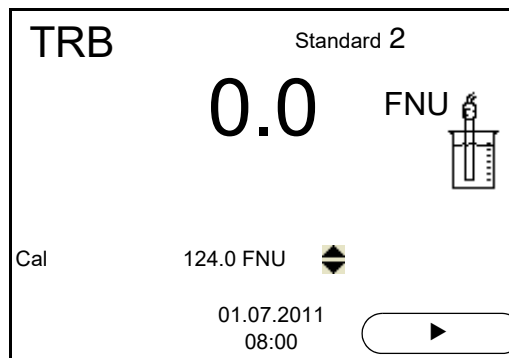

Continuing with two-point calibration

- 11 Thoroughly rinse the turbidity sensor with distilled water and dry it with a lint-free cloth.
- 12 Immerse the turbidity sensor in the test sample at an angle.
- 13 Position the turbidity sensor in the measuring vessel.
- 14 Use **<▲ >** **<▼ >** and **<F2>/[▶]** to set the concentration of the standard solution for each digit and confirm with **<ENTER>**.
The standard solution is measured.
The measured value is checked for stability (AutoRead).

- 15 Wait for the end of the AutoRead measurement.
The calibration display for the next standard solution appears.

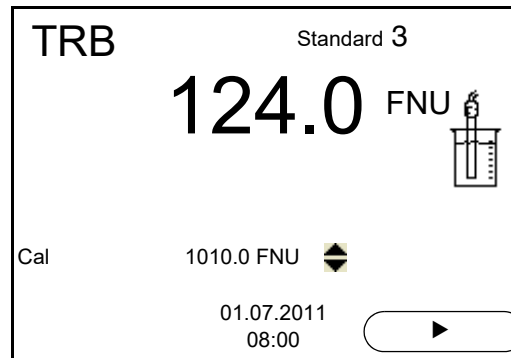

- 16 If necessary, terminate the calibration as a two-point calibration with **<M>**.
The new calibration values are displayed.
or
Continue with three-point calibration.

Continuing with three-point calibration

Repeat the steps 11 to 15 with the third standard solution. The new calibration values are displayed after the last calibration step was completed.

9.2.5 Calibration data

Displays the calibration data



Calibration The calibration protocol of the last calibration is available in the menu **<ENTER>** / *Calibration record*. To open it in the measured value display, press the **<CAL__>** key.

The calibration records of the last 10 calibrations are available in the menu *Calibration / Calibration data storage / Display*. To open the *Calibration* menu in the measured value display, press the **<ENTER>** key.

Menu item	Setting/function	Explanation
<i>Calibration / Calibration data storage / Display</i>	-	Displays the calibration record. Further options: <ul style="list-style-type: none"> ● Scroll through the calibration records with << >> <> >. ● Output the displayed calibration record to the interface with <PRT>. ● Output all calibration records to the interface with <PRT_>. ● Quit the display with <ESC> or <ENTER>. ● Switch directly to the measured value display with <M>.
<i>Calibration / Calibration data storage / Output to RS232/USB</i>	-	Outputs the calibration records to the interface.

Calibration evaluation

After calibrating, the meter automatically evaluates the calibration.

Display	Calibration record	Explanation
	+++	Optimum calibration
		Good calibration

Calibration record (USB output)

CALIBRATION TRB: 18.09.2016 08:09:10	
VisoTurb 900-P Ser. no. 14E999003	
# 1	0.0 FNU
# 2	124.0 FNU
Sensor	+++

10 Settings

10.1 pH measurement settings

10.1.1 Settings for pH measurements

Settings The settings are made in the menu for calibration and measurement settings of the pH/ORP measurement. To open the settings, display the required measured parameter in the measured value display and press the **<ENTER>** key. After completing the settings, switch to the measured value display with **<M>**. Default settings are printed in **bold**.

Menu item	Possible setting	Description
<i>Calibration / Calibration record</i>	-	Displays the calibration record of the last calibration.
<i>Calibration / Calibration data storage / Display</i>	-	Displays the last calibration records (max. 10)
<i>Calibration / Calibration data storage / Output to RS232/USB</i>	-	Outputs the calibration data storage to the interface
<i>Calibration / Buffer</i>	TEC <i>ConCal</i> <i>NIST/DIN</i> ...	Buffer sets to be used for pH calibration. More buffers and details: see section 10.1.2 BUFFER SETS FOR CALIBRATION, page 68 and section 5.2 PH CALIBRATION, page 28.
<i>Calibration / Single-point calibration</i>	<i>yes</i> no	Quick calibration with 1 buffer
<i>Calibration / Calibration interval</i>	1 ... 7 ... <i>999 d</i>	<i>Calibration interval</i> for the IDS pH sensor (in days). The meter reminds you to calibrate regularly by the flashing sensor symbol in the measuring screen.
<i>Calibration / Unit for slope</i>	mV/pH %	Unit of the slope. The % display refers to the Nernst slope of -59.2 mV/pH (100 x determined slope/Nernst slope).
<i>QSC / First calibration</i>	-	Starts the initial calibration with QSC buffers. This menu item is only available as long as no initial calibration was carried out with the connected IDS sensor.
<i>QSC / Record of first calibration</i>	-	Displays the calibration record of the QSC initial calibration.
<i>QSC / Control calibration</i>	-	Starts the control calibration with QSC buffers. This menu item is only available if an initial calibration was carried out with the connected IDS sensor.
<i>Man. temperature</i>	-25 ... +25 ... +130 °C	Entry of the manually determined temperature. This menu item is only available if an IDS adapter is connected.

Menu item	Possible setting	Description
<i>pH resolution</i>	0.001 0.01 0.1	Resolution of the pH display
<i>mV resolution</i>	0.1 1	Resolution of the mV display
<i>Reset</i>	-	Resets all sensor settings to the delivery condition (see section 10.7.1 RESETTING THE MEASUREMENT SETTINGS, page 78).

10.1.2 Buffer sets for calibration

You can use the buffer sets quoted in the table for an automatic calibration. The pH values are valid for the specified temperature values. The temperature dependence of the pH values is taken into consideration during the calibration.

No.	Buffer set *	pH values	at
1	<i>ConCal</i>	Any	Any
2	<i>NIST/DIN</i> DIN buffers according to DIN 19266 and NIST Traceable Buffers	1.679 4.006 6.865 9.180 12.454	25 °C
3	<i>TEC</i> WTW Technical buffers	2.000 4.010 7.000 10.011	25 °C
4	<i>Merck 1*</i>	4.000 7.000 9.000	20°C
5	<i>Merck 2 *</i>	1.000 6.000 8.000 13.000	20°C
6	<i>Merck 3 *</i>	4.660 6.880 9.220	20°C
7	<i>Merck 4 *</i>	2.000 4.000 7.000 10.000	20°C
8	<i>Merck 5 *</i>	4.010 7.000 10.000	25 °C

No.	Buffer set *	pH values	at
9	<i>DIN 19267</i>	1.090 4.650 6.790 9.230	25 °C
10	<i>Mettler Toledo USA *</i>	1.679 4.003 7.002 10.013	25 °C
11	<i>Mettler Toledo EU *</i>	1.995 4.005 7.002 9.208	25 °C
12	<i>Fisher *</i>	2.007 4.002 7.004 10.002	25 °C
13	<i>Fluka BS *</i>	4.006 6.984 8.957	25 °C
14	<i>Radiometer *</i>	1.678 4.005 7.000 9.180	25 °C
15	<i>Baker *</i>	4.006 6.991 10.008	25 °C
16	<i>Metrohm *</i>	3.996 7.003 8.999	25 °C
17	<i>Beckman *</i>	4.005 7.005 10.013	25 °C
18	<i>Hamilton Duracal *</i>	4.005 7.002 10.013	25 °C
19	<i>Precisa *</i>	3.996 7.003 8.999	25 °C
20	<i>Reagecon TEC *</i>	2.000 4.010 7.000 10.000	25 °C

No.	Buffer set *	pH values	at
21	<i>Reagecon 20</i> *	2.000 4.000 7.000 10.000 13.000	20 °C
22	<i>Reagecon 25</i> *	2.000 4.000 7.000 10.000 13.000	25 °C
23	<i>Riedel-de Haen</i> *	2.000 4.000 7.000 10.000	20 °C
24	<i>USABlueBook</i> *	4.000 7.000 10.000	25 °C
25	<i>YSI</i> *	4,000 7,000 10,000	25 °C

* Brand names or trade names are trademarks of their respective owners protected by law.



The buffers are selected in the menu, pH / **<ENTER>** / *Calibration / Buffer* (see section 10.1.1 SETTINGS FOR PH MEASUREMENTS, page 67).

10.1.3 Calibration interval

The calibration evaluation is displayed as a sensor symbol.

After the QSC function has been enabled the sensor symbol is replaced by the QSC scale (see section 5.2.8 QSC FUNCTION (SENSOR QUALITY CONTROL), page 38).

After the specified calibration interval has expired the sensor symbol or the QSC scale flashes. It is still possible to measure.



To ensure the high measuring accuracy of the measuring system, calibrate after the calibration interval has expired.

Setting the calibration interval

The calibration interval is set to 7 days in the factory.

You can change the interval (1 ... 999 days):

1. Open the menu for measurement settings with **<ENTER>**.
2. In the *Calibration / Calibration interval* menu, set the calibration interval with **<▲ ><▼ >**.
3. Confirm the setting with **<ENTER>**.
4. Quit the menu with **<M>**.

10.2 ORP measurement settings

10.2.1 Settings for ORP measurements

The settings are made in the menu for measuring settings of the ORP measurement. To open the settings, display the required measured parameter in the measured value display and press the **<ENTER>** key. After completing the settings, switch to the measured value display with **<M>**.

Default settings are printed in **bold**.

Menu item	Possible setting	Description
<i>mV resolution</i>	0.1 1	Resolution of the mV display
<i>Reset</i>	-	Resets all sensor settings to the delivery condition (see section 10.7.1 RESETTING THE MEASUREMENT SETTINGS, page 78).

10.3 D.O. measurement settings

10.3.1 Settings for D.O. sensors (menu for measurement and calibration settings)

Settings

The settings are available in the menu for measurement and calibration settings. To open the settings, display the required measured parameter in the measured value display and press the **<ENTER>** key. After completing the settings, switch to the measured value display with **<M>**.

Default settings are printed in **bold**.

Menu item	Possible setting	Description
<i>Calibration / Calibration record</i>	-	Displays the calibration record of the last calibration.
<i>Calibration / Calibration data storage / Display</i>	-	Displays the last calibration records (max. 10)

Menu item	Possible setting	Description
<i>Calibration / Calibration data storage / Output to RS232/USB</i>	-	Outputs the calibration data storage to the interface
<i>Calibration / Calibration interval</i>	1 ... 180 ... 999 d	<i>Calibration interval</i> for the IDS D.O. sensor (in days). The meter reminds you to calibrate regularly by the flashing sensor symbol in the measuring screen.
<i>Calibration / Comparison meas.</i>	on off	Enables to adjust the measured value with the aid of a comparison measurement, e.g. Winkler titration. For details, see section 7.3 CALIBRATION, page 49.
<i>FDO Check / Start FDO Check</i>	-	Starts the FDO [®] check procedure
<i>FDO Check / Check interval</i>	1 ... 60 ... 999 d	Interval for the <i>FDO Check</i> (in days). The meter reminds you to check the sensor regularly by <i>FDO Check</i> status indicator in the measuring screen.
<i>Sal correction</i>	on off	Manual salt content correction for concentration measurements.
<i>Salinity</i>	0.0 ... 70.0	Salinity or salinity equivalent for the salt content correction. This menu item is only available if the manual salt content correction is switched on.
<i>Response time t90</i>	30 ... 300 s	Response time of the signal filter (in seconds). A signal filter in the sensor reduces the limits of variation of the measured value. The signal filter is characterized by the response time t90. This is the time after which 90 % of a signal change is displayed.
<i>Reset</i>	-	Resets all sensor settings to the delivery condition (see section 10.7.1 RESETTING THE MEASUREMENT SETTINGS, page 78).

10.4 Cond measurement settings

10.4.1 Settings for IDS conductivity sensors

Settings

The settings are made in the menu for the measured parameter, conductivity. To open the settings, display the required measured parameter in the measured value display and press the **<ENTER>** key. After completing the settings, switch to the measured value display with **<M>**.

The possible settings are individually displayed for each sensor. Below the setting menu is displayed for two IDS sensors (TetraCon 925, LR 925/01).

Default settings are printed in **bold**.

Setting menu of TetraCon 925

Menu item	Possible setting	Description
<i>Calibration / Calibration record</i>	-	Displays the calibration record of the last calibration.
<i>Calibration / Calibration data storage / Display</i>	-	Displays the last calibration records (max. 10)
<i>Calibration / Calibration data storage / Output to RS232/USB</i>	-	Outputs the calibration data storage to the interface
<i>Calibration / Calibration interval</i>	1 ... 150 ... 999 d	<i>Calibration interval</i> for the IDS conductivity sensor (in days). The meter reminds you to calibrate regularly by the flashing sensor symbol in the measuring screen.
<i>Type</i>	cal <i>man</i>	Measuring cell used Measuring cells whose cell constant is determined by calibration in the KCL control standard solution. Calibration range: 0.450 to 0.500 cm ⁻¹ The currently valid cell constant is displayed in the status line. Manually adjustable cell constant in the range 0.450 ... 0.500 cm ⁻¹ .
<i>Cell const. man</i>	0.450 ... 0.475 ... 0.500 cm ⁻¹	Display and setting options for the manually adjustable cell constant.
<i>Temp. comp. (TC) / Method</i>	nLF <i>Lin</i> <i>off</i>	Procedure for temperature compensation (see section 8.2 TEMPERATURE COMPENSATION, page 56). This setting is only available for the measured parameters, conductivity (χ) and resistivity (ρ).

Menu item	Possible setting	Description
<i>Temp. comp. (TC) / Linear coeff.</i>	0.000 ... 2.000 ... 3.000 %/K	Coefficient of the linear temperature compensation. This menu item is only available when the linear temperature compensation is set.
<i>Temp. comp. (TC) / Reference temp.</i>	20 °C 25 °C	Reference temperature This setting is only available for the measured parameters, conductivity (χ) and resistivity (ρ).
<i>Multiplier for TDS</i>	0.40 ... 1.00	Multiplier for TDS value
<i>Reset</i>	-	Resets all sensor settings to the delivery condition (see section 10.7.1 RESETTING THE MEASUREMENT SETTINGS, page 78).

Setting menu of
LR 925/01

Menu item	Possible setting	Description
<i>Cell constant</i>	0.090 0.100 ... 0.110 cm ⁻¹	Display and setting options for the cell constant
<i>Temp. comp. (TC) / Method</i>	nLF Lin off	Procedure for temperature compensation (see section 8.2 TEMPERATURE COMPENSATION, page 56). This setting is only available for the measured parameters, conductivity (χ) and resistivity (ρ).
<i>Temp. comp. (TC) / Linear coeff.</i>	0.000 ... 2.000 ... 3.000 %/K	Coefficient of the linear temperature compensation. This menu item is only available when the linear temperature compensation is set.
<i>Temp. comp. (TC) / Reference temp.</i>	20 °C 25 °C	Reference temperature This setting is only available for the measured parameters, conductivity (χ) and resistivity (ρ).
<i>Multiplier for TDS</i>	0.40 ... 1.00	Multiplier for TDS value
<i>Reset</i>	-	Resets all sensor settings to the delivery condition (see section 10.7.1 RESETTING THE MEASUREMENT SETTINGS, page 78).

10.5 Turb measurement settings

10.5.1 Settings for turbidity sensors

The settings are made in the menu for the measured parameter, turbidity. To open the settings, display the required measured parameter in the measured value display and press the **<ENTER>** key. After completing the settings, switch to the measured value display with **<M>**.

The possible settings are individually displayed for each sensor. Default settings are printed in **bold**.

Setting menu of the VisoTurb® 900-P

Menu item	Possible setting	Explanation
<i>Calibration / Calibration record</i>	-	Displays the calibration record of the last calibration.
<i>Calibration / Calibration data storage / Display</i>	-	Displays the last calibration records (max. 10)
<i>Calibration / Calibration data storage / Copy to USB flash drive</i>	-	Outputs the stored calibration data to a connected USB memory device/ USB printer)
<i>Calibration / Calibration data storage / Output to RS232/USB</i>	-	Outputs the calibration data storage to the interface
<i>Calibration / Calibration interval</i>	1 ... 30 ... 999 d	<i>Calibration interval</i> for the turbidity sensor (in days). The meter reminds you to calibrate regularly by the flashing sensor symbol in the measuring screen.
<i>Resolution</i>	0.1 1	Resolution of the FNU/NTU display
<i>Reset</i>	-	Resets all sensor settings to the delivery condition (see section 10.7.1 RESETTING THE MEASUREMENT SETTINGS, page 78).

10.6 Sensor-independent settings

10.6.1 System

To open the *Storage & config* menu, press the **<ENTER_ >** key in the measured value display. After completing the settings, switch to the measured value display with **<M>**.

Default settings are printed in **bold**.

Menu item	Setting	Description
<i>System / General / Language</i>	<i>Deutsch</i> English (more)	Selects the menu language
<i>System / General / Audio signal</i>	on off	Switches on/off the beep on keystroke
<i>System / General / Illumination</i>	Auto on off	Switches the display illumination on/off
<i>System / General / Contrast</i>	0 ... 50 ... 100	Changes the display contrast
<i>System / General / Shutoff time</i>	10 min ... 1h ... 24 h	Adjusts the shutoff time
<i>System / General / Temperature unit</i>	°C °F	Temperature unit, degrees Celsius or degrees Fahrenheit. All temperature values are displayed with the selected unit.
<i>System / General / Stability control</i>	on off	Switches on or off the automatic stability control during measurement (see section 10.6.3 AUTOMATIC STABILITY CONTROL, page 77)
<i>System / Interface / Baud rate</i>	1200, 2400, 4800 , 9600, 19200	Baud rate of the USB Device interface
<i>System / Interface / Output format</i>	ASCII CSV	Output format for data transmission For details, see section 12 TRANSMITTING DATA (USB INTERFACES), page 87
For: <i>Output format CSV:</i>		
● <i>System / Interface / Decimal separator</i>	<i>Dot (xx.x)</i> <i>Comma (xx,x)</i>	Decimal separator
● <i>System / Interface / Output header</i>		Output of a header
<i>System / Clock function</i>	<i>Date format</i> <i>Datum</i> <i>Time</i>	Settings of time and date. For details, see section 4.5.5 EXAMPLE 2 ON NAVIGATION: SETTING THE DATE AND TIME, page 24
<i>System / Service information</i>		Hardware version and software version of the meter are displayed.

Menu item	Setting	Description
System /Reset	-	Resets the system settings to the default values. For details, see section 10.7.2 RESET-TING THE SYSTEM SETTINGS, page 80

10.6.2 Data storage

This menu contains all functions to display, edit and erase stored measured values.



Detailed information on the memory functions of the Multi 3510 IDS are given in section 11 DATA STORAGE, page 81.

10.6.3 Automatic Stability control

The automatic *Stability control* (AutoRead) function continuously checks the stability of the measurement signal. The stability has a considerable impact on the reproducibility of measured values.

You can activate or switch off the automatic *Stability control* function (see section 10.6 SENSOR-INDEPENDENT SETTINGS, page 76).

The measured parameter flashes on the display

- as soon as the measured value is outside the stability range
- when the automatic *Stability control* is switched off.

10.6.4 Automatic shutoff function

The instrument has an automatic shutoff function in order to save the batteries (see section 10.6.1 SYSTEM, page 76). The automatic shutoff function switches off the meter if no key is pressed for an adjustable period.

The automatic shutoff function is not active

- if the power pack is connected
- if a USB-B cable is connected
- if the *Automatic data storage* function is active, or with *automatic data transmission*

10.6.5 Display illumination

The meter automatically switches off the display illumination if no key is pressed for 20 seconds.

The illumination is switched on with the next keystroke again.

You can also generally switch on the display illumination (see section 10.6.1 SYSTEM, page 76).

10.7 Reset

You can reset (initialize) all sensor settings and sensor-independent settings separately from each other.

10.7.1 Resetting the measurement settings



The calibration data are reset to the default settings together with the measuring parameters. Recalibrate after performing a reset.

pH The following settings for pH measurements are reset to the default settings with the *Reset* function:

Setting	Default settings
<i>Buffer</i>	TEC
<i>Calibration interval</i>	7 d
<i>Unit for slope</i>	mV/pH
<i>Measured parameter</i>	pH
<i>Unit for slope</i>	0.001
<i>mV resolution</i>	0.1
<i>Asymmetry</i>	0 mV
<i>Slope</i>	-59.2 mV
<i>Man. temperature</i>	25 °C
<i>Single-point calibration</i>	off

The sensor settings are reset under the *Reset* menu item in the menu for calibration and measurement settings. To open the settings, display the required measured parameter in the measured value display and press the **<ENTER>** key.

ORP The following settings for ORP measurements are reset to the default settings with the *Reset* function:

Setting	Default settings
<i>mV resolution</i>	0.1
<i>Man. temperature</i>	25 °C

The sensor settings are reset under the *Reset* menu item in the menu for calibration and measurement settings. To open the settings, display the required measured parameter in the measured value display and press the **<ENTER>** key.

Dissolved oxygen The following settings for D.O. measurements are reset to the default settings with the *Reset* function:

Setting	Default settings
<i>Calibration interval</i>	180 d
<i>Check interval</i>	60 d
<i>Measured parameter</i>	D.O. concentration (mg/l)
<i>Relative slope (S_{Rel})</i>	1.00
<i>Salinity (value)</i>	0.0
<i>Salinity (function)</i>	off

The sensor settings are reset under the *Reset* menu item in the menu for calibration and measurement settings. To open the settings, display the required measured parameter in the measured value display and press the **<ENTER>** key.

Conductivity The following settings for conductivity measurements are reset to the default settings with the *Reset* function:

Setting	Default settings
<i>Calibration interval</i>	150 d
<i>Measured parameter</i>	χ
<i>Cell constant (c)</i>	Depending on the connected measuring cell: 0.475 cm ⁻¹ (calibrated) 0.475 cm ⁻¹ (set) 0.100 cm ⁻¹
<i>Temperature compensation</i>	nLF
<i>Reference temperature</i>	25 °C
<i>Temperature coefficient (TC) of the linear temperature compensation</i>	2.000 %/K
<i>Multiplier for TDS</i>	1.00

The sensor settings are reset under the *Reset* menu item in the menu for calibration and measurement settings. To open the settings, display the required measured parameter in the measured value display and press the **<ENTER>** key.

10.7.2 Resetting the system settings

The following system settings can be reset to the default condition:

Setting	Default settings
<i>Language</i>	English
<i>Audio signal</i>	on
<i>Baud rate</i>	4800 Baud
<i>Output format</i>	ASCII
<i>Decimal separator</i>	.
<i>Contrast</i>	50
<i>Illumination</i>	Auto
<i>Shutoff time</i>	1 h
<i>Temperature unit</i>	°C
<i>Stability control</i>	on

The system settings are reset in the menu, *Storage & config / System / Reset*. To open the *Storage & config* menu, press the **<ENTER_ >** key in the measured value display.

11 Data storage

You can save measured values (datasets) to the data storage:

- Manual data storage (see section 11.1 MANUAL DATA STORAGE, page 81)
- Automatic data storage at intervals (see section 11.2 AUTOMATIC DATA STORAGE AT INTERVALS, page 82)

Each data storage process transmits the current dataset to the USB interface.

11.1 Manual data storage

You can save a measurement dataset to the data storage as follows. The dataset is at the same time output to the USB interface:

1. Press the **<STO>** key shortly.
The menu for manual data storage appears.

2. If necessary, change and confirm the ID number (1 ... 10000) with **<▲ ><▼ >** and **<ENTER>**.
The dataset is stored. The meter switches to the measured value display.

If the data storage is full

When all data storage locations are occupied, it is not possible to continue storing. Then you can e.g. transmit the stored data to a PC (see section 11.3.1 EDITING THE MEASURED VALUE DATA STORAGE, page 84) and subsequently erase the data storage (see section 11.3.2 ERASING THE MEASUREMENT DATA STORAGE, page 85).

11.2 Automatic data storage at intervals

The data storage interval (*Interval*) determines the time interval between automatic data storage processes. Each data storage process transmits the current dataset to the USB interface.

Configuring the automatic data storage function

1. Press the **<STO_>** key.
The menu for automatic data storage appears.

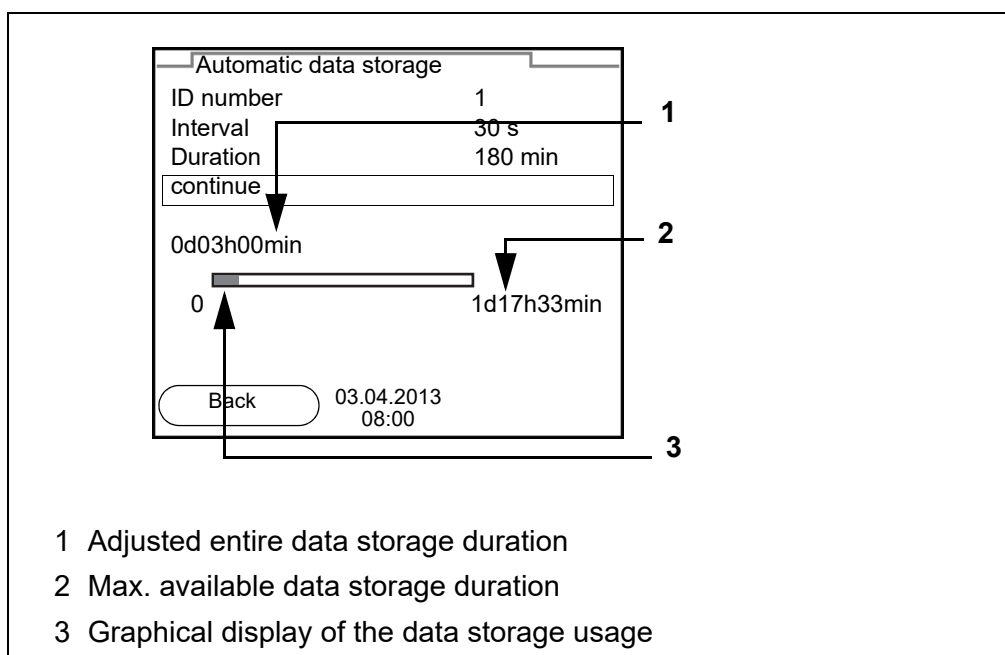

Settings

You can configure the automatic data storage function with the following settings:

Menu item	Possible setting	Description
<i>ID number</i>	1 ... 10000	ID number for the dataset series.
<i>Interval</i>	1 s, 5 s, 10 s, 30 s, 1 min, 5 min, 10 min, 15 min, 30 min, 60 min	Storage interval. The lower limit of the storage interval can be restricted by the number of free storage locations. The upper limit is restricted by the storage duration.
<i>Duration</i>	1 min ... x min	Storage duration. Specifies after which time the automatic data storage should be terminated. The lower limit of the storage duration is restricted by the storage interval. The upper limit is restricted by the number of free storage locations.

Starting the automatic data storage function

To start the automatic data storage function, select *continue* with **<▲ ><▼ >** and confirm with **<ENTER>**. The meter switches to the measured value display.

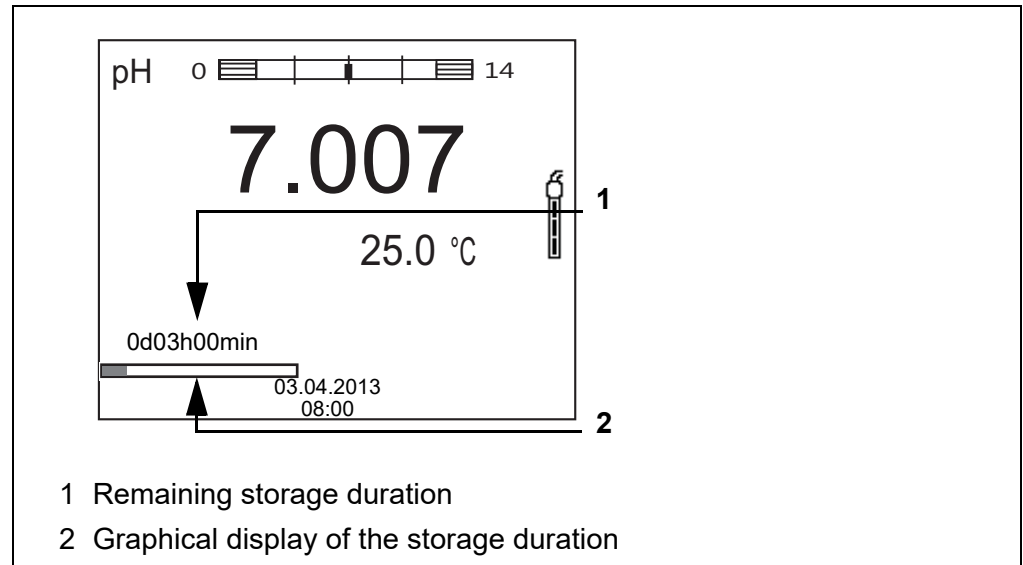

- 1 Remaining storage duration
- 2 Graphical display of the storage duration

The active automatic data storage function can be recognized by the progress bar in the status line. The progress bar indicates the remaining storage duration.



If the automatic data storage function is activated, only the following keys are active: **<M>**, **<STO_ >** and **<On/Off>**. The other keys and the automatic switch-off function are deactivated.

Terminating the automatic data storage function prematurely

Proceed as follows to switch off the automatic data storage function before the adjusted storage duration has expired:

1. Press the **<STO_ >** key.
The following window appears.

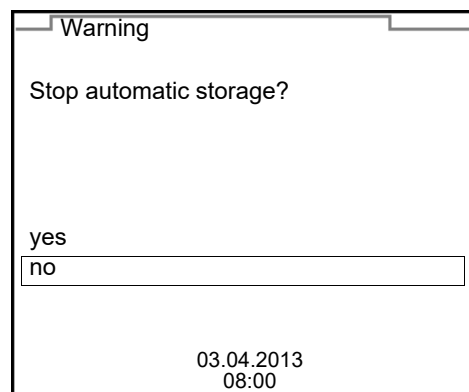

2. Using **<▲ ><▼ >**, select *yes* and confirm with **<ENTER>**.
The meter switches to the measured value display.
The automatic data storage function is terminated.

11.3 Measured value data storage

11.3.1 Editing the measured value data storage

The contents of the manual or automatic measurement data storage can be shown on the display.

Each of the measurement data storages has a function to erase the entire contents.

Editing the data storage

The data storage is edited in the menu, *Storage & config / Data storage*. To open the *Storage & config* menu, press the **<ENTER_ >** key in the measured value display.

Open the manual or automatic data storage directly with the **<RCL>** or **<RCL_ >** key.



The settings are explained here using the manual data storage as an example. The same settings and functions are available for the automatic data storage.

Settings

Menu item	Setting/function	Description
<i>Data storage / Manual data storage / Display</i>	-	Displays all measurement datasets page by page. Further options: <ul style="list-style-type: none"> ● Scroll through the datasets with <▲ ><▼ >. ● Output the displayed dataset to the interface with <F2>/[USB output]. ● Quit the display with <F1>/[Back].
<i>Data storage / Manual data storage / Output to RS232/USB</i>	-	Outputs all stored measurement data to the interface.
<i>Data storage / Manual data storage / Erase</i>	-	Erases the entire manual measurement data storage. Note: All calibration data remain stored when this action is performed.

Display representation of a dataset

Manual data storage	3 of 64	▲
03.04.2013 07:43:33 ID number: 1		
SenTix 940	B20234008565	
pH 7.000	24.8 °C	AR Sensor: +++
Back	03.04.2013 08:00	USB output

Representation of a dataset (USB output)

```

03.04.2013 07:43:33
Multi 3510 IDS
Ser. no. 09250023

ID number 2

SenTix 940
Ser. no. B092500013
pH 6.012 24.8 °C, AR, S: +++

-----

03.04.2013 07:43:53
Multi 3510 IDS
Ser. no. 09250013

ID number 2

SenTix 940
Ser. no. B092500013
pH 6.012 24.8 °C, AR, S: +++

-----

etc...

```

Quitting the display

To quit the display of stored measurement datasets, you have the following options:

- Switch directly to the measured value display with **<M>**.
- Quit the display and move to the next higher menu level with **<F1>/[Back]**.

11.3.2 Erasing the measurement data storage

Erasing the measurement data storage (see section 11.3.1 EDITING THE MEASURED VALUE DATA STORAGE, page 84).

11.3.3 Measurement dataset

A complete dataset includes:

- Date/time
- Meter name, series number
- Sensor name, series number

- ID number
- Measured value of the connected sensor
- Measured temperature value of the connected sensor
- AutoRead info: *AR* appears with the measured value if the AutoRead criterion was met while storing (stable measured value). Otherwise, the *AR* display is missing.
- Calibration evaluation:
 - 4 levels (+++, ++, +, -, or no evaluation) or
 - QSC (percentage)

11.3.4 Storage locations

The Multi 3510 IDS meter has two measurement data storages. The measured values recorded either manually or automatic are stored separately in individual measurement data storages.

Data storage	Maximum number of datasets
<i>Manual data storage</i>	494
<i>Automatic data storage</i>	4500

12 Transmitting data (USB interfaces)

12.1 Outputting current measurement data

1. Output the current measurement data to the USB-B interface with **<F2>**[*USB output*].

12.2 Transmitting data (to a PC)

The meter has a USB-B interface (*USB Device*) e.g. to connect a PC.

Via the USB-B interface (*USB Device*) you can transmit data to a PC or printer and update the meter software.

12.3 Connecting the PC / USB-B interface (*USB Device*)

Connect the Multi 3510 IDS to the PC via the USB-B interface.

Installation of the USB driver on the PC

System requirements of the PC for installation of the USB driver:

- PC with at least one free USB connection and CD-ROM drive
- Windows 2000, Windows XP, Windows Vista or Windows 7.

1. Insert the supplied installation CD in the CD drive of your PC.
2. Install the driver from the CD.
Follow the Windows installation instructions as necessary.
3. Connect the Multi 3510 IDS to the PC via the USB-B interface.
The meter is listed as a virtual COM interface among the connections in the Windows instrument manager.
4. Set the same transmission data at the connected instrument (PC):
 - Baud rate: to be selected in the range 1200 ... 19200
 - Handshake: RTS/CTS
 - Set at the PC only:
 - Parity: none
 - Data bits: 8
 - Stop bits: 2

12.4 Options for data transmission to a PC

Via the USB-B interface you can transmit data to a PC. The following table shows which data are transmitted to the interface in which way:

Data	Control	Operation / description
Current measured values of all connected sensors	manual	<ul style="list-style-type: none"> ● With <F2>/[USB output]. ● Simultaneously with every manual storage process (see section 11.1 MANUAL DATA STORAGE, page 81).
	automatic, at intervals	<ul style="list-style-type: none"> ● With <F2__>/[USB output]. Then you can set the transmission interval. ● Simultaneously with every automatic storage process (see section 11.2 AUTOMATIC DATA STORAGE AT INTERVALS, page 82).
Stored measured values	manual	<ul style="list-style-type: none"> ● Displayed dataset with <F2>[USB output] after calling up from the data storage. ● All datasets with the <i>Output to RS232/USB</i> function. (see section 11.3.1 EDITING THE MEASURED VALUE DATA STORAGE, page 84).
Calibration records	manual	<ul style="list-style-type: none"> ● Calibration record with <F2>/[USB output] (see section 5.2.6 CALIBRATION DATA, page 35; section 7.3.6 CALIBRATION DATA, page 51; section 8.3.4 CALIBRATION DATA, page 58).
	automatic	<ul style="list-style-type: none"> ● At the end of a calibration procedure.



The following rule applies: With the exception of the menus, shortly pressing the **<F2>**/[USB output] key generally outputs the display contents to the interface (displayed measured values, measuring datasets, calibration records).

12.5 MultiLab Importer

With the aid of the MultiLab Importer software, you can record and evaluate measuring data with a PC.



More detailed information can be found in the MultiLab Importer operating manual.

With the aid of the BOD Analyst Pro software you can administrate BOD measurement on the PC and automatically calculate the measured values.

13 Maintenance, cleaning, disposal

13.1 Maintenance

13.1.1 General maintenance activities

The only maintenance activity required is replacing the batteries.



See the relevant operating manuals of the IDS sensors for instructions on maintenance.

13.1.2 Replacing the batteries



You can operate the meter either with normal batteries or with rechargeable batteries (Ni-MH). In order to charge the batteries, an external charging device is required.

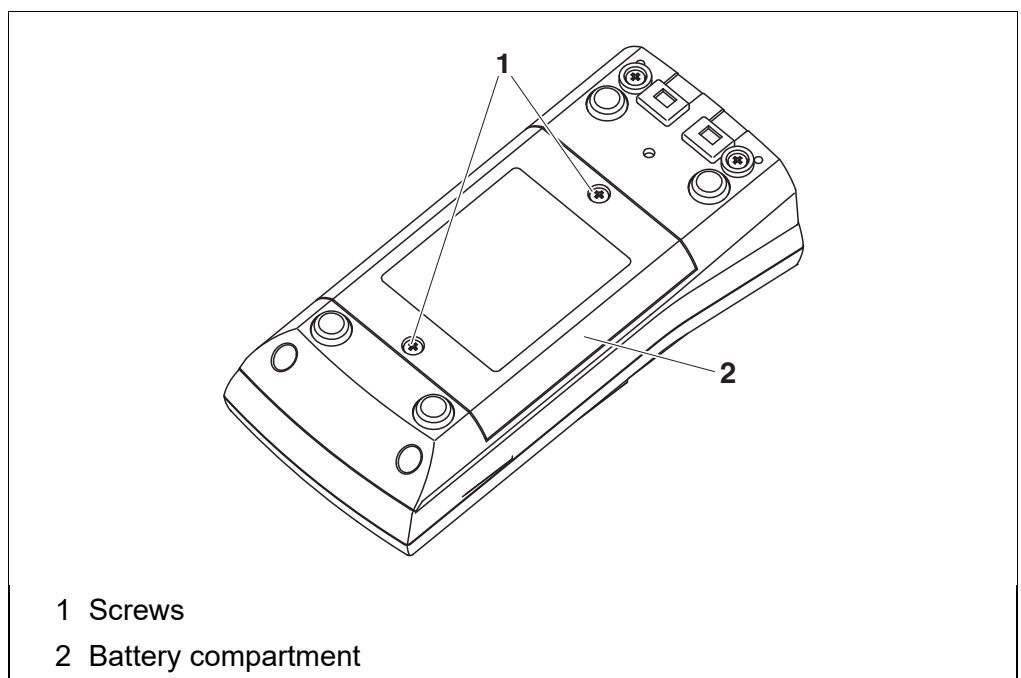

1. Unscrew the two screws (1) on the underside of the meter.
2. Open the battery compartment (2) on the underside of the meter.
3. Remove the batteries from the battery compartment.



CAUTION

Make sure that the poles of the batteries are positioned correctly.

The \pm signs on the batteries must correspond to the \pm signs in the battery compartment.



You can operate the meter either with normal batteries or with rechargeable batteries (Ni-MH). In order to charge the batteries, an external charging device is required.

4. Place four batteries (type Mignon AA) in the battery compartment.
5. Close the battery compartment (2).
6. Set the date and time (see section 4.5.5 EXAMPLE 2 ON NAVIGATION: SETTING THE DATE AND TIME, page 24).



Dispose of used batteries according to the local regulations of your country.

End users within the European Union are obligated to return used batteries (even ecologically compatible ones) to a collection point set up for recycling purposes.

Batteries are marked with the crossed-out waste container symbol. Therefore, they may not be disposed with the domestic waste.

13.2 Cleaning

Occasionally wipe the outside of the measuring instrument with a damp, lint-free cloth. Disinfect the housing with isopropanol as required.



CAUTION

The housing is made of synthetic material (ABS). Thus, avoid contact with acetone or similar detergents that contain solvents. Remove any splashes immediately.

13.3 Packing

This meter is sent out in a protective transport packing.

We recommend: Keep the packing material. The original packing protects the meter against damage during transport.

13.4 Disposal

At the end of its operational lifetime, the meter must be returned to the disposal or return system statutory in your country. If you have any questions, please contact your supplier.

14 What to do if...

14.1 pH



More information and instructions on cleaning and exchange of sensors are given in the documentation of your sensor.

Error message *OFL, UFL*

Cause	Remedy
IDS pH sensor:	
– Measured value outside the measuring range	– Use suitable IDS pH sensor
– Air bubble in front of the junction	– Remove air bubble
– Air in the junction	– Extract air or moisten junction
– Cable broken	– Exchange IDS pH sensor
– Gel electrolyte dried out	– Exchange IDS pH sensor

Error message, *Error*

Cause	Remedy
IDS pH sensor:	
– The values determined for zero point and slope of the pH sensor are outside the allowed limits.	– Recalibrate
– Junction contaminated	– Clean junction
– pH sensor broken	– Exchange IDS pH sensor
Buffer solutions:	
– The used buffer solutions do not agree with the set buffer set	– Set different buffer set or – Use different buffer solutions
– Buffer solutions too old	– Use only once. Note the shelf life
– Buffer solutions depleted	– Change solutions

No stable measured value	Cause	Remedy
	IDS pH sensor:	
	– Junction contaminated	– Clean junction
	– Membrane contaminated	– Clean membrane
	Test sample:	
	– pH value not stable	– Measure with air excluded if necessary
	– Temperature not stable	– Adjust temperature if necessary
	IDS pH sensor + test sample:	
	– Conductivity too low	– Use suitable IDS pH sensor
	– Temperature too high	– Use suitable IDS pH sensor
	– Organic liquids	– Use suitable IDS pH sensor

Obviously incorrect measured values	Cause	Remedy
	IDS pH sensor:	
	– pH sensor unsuitable	– Use suitable IDS sensor
	– Temperature difference between buffer and test sample too great	– Adjust temperature of buffer or sample solutions
	– Measurement procedure not suitable	– Follow special procedure

14.2 Dissolved oxygen



More information and instructions on cleaning and exchange of sensors are given in the documentation of your sensor.

**Error message,
OFL, UFL**

The measured value is outside the measuring range.

Cause	Remedy
– Measured value outside the measuring range	– Use a suitable IDS D.O. sensor

**Error message,
Error**

Cause	Remedy
– Sensor contaminated	– Clean the sensor
– Measured temperature value outside the operating conditions (display of OFL/UFL instead of a temperature value)	– Keep to the temperature range for the test sample
– Defective sensor	– Replace sensor

14.3 Conductivity

More information and instructions on cleaning and exchange of sensors are given in the documentation of your sensor.

**Error message,
OFL, UFL**

The measured value is outside the measuring range.

Cause	Remedy
– Measured value outside the measuring range	– Use suitable IDS conductivity sensor

**Error message,
Error**

Cause	Remedy
– Sensor contaminated	– Clean the sensor and replace it if necessary
– Calibration solution not suitable	– Check the calibration solutions

14.4 Turbidity**Implausible turbidity
values**

Cause	Remedy
– There are gas bubbles (e.g. air bubbles) in front of the measurement window	– Remove the gas bubbles, e.g. by immersing the sensor at an angle

	Cause	Remedy
	<ul style="list-style-type: none"> – Incorrect calibration, e.g.: <ul style="list-style-type: none"> – Unsuitable calibration standard solutions (e.g. too old) – Unsuitable calibration environment (e.g. gas bubbles, reflection, light) 	<ul style="list-style-type: none"> – Check the calibration
	<ul style="list-style-type: none"> – Minimum depth of immersion not observed 	<ul style="list-style-type: none"> – Heed the minimum depth of immersion of the sensor (2 cm)
Error message, OFL	Cause <ul style="list-style-type: none"> – Measured value outside the measuring range 	Remedy <ul style="list-style-type: none"> – Select a suitable measuring medium
Measured values too low	Cause <ul style="list-style-type: none"> – Measurement window soiled 	Remedy <ul style="list-style-type: none"> – Clean the measurement window
Measured values too high	Cause <ul style="list-style-type: none"> – Reflection at the walls or bottom of the measuring vessel 	Remedy <ul style="list-style-type: none"> – Keep the minimum distance of the sensor towards the walls and bottom of the measuring vessel (see section 9.1.1 MEASURING THE TURBIDITY, page 60)
	<ul style="list-style-type: none"> – Incidence of light 	<ul style="list-style-type: none"> – Use a light-proof measuring vessel



More information and instructions on cleaning and exchange of sensors are given in the documentation of your sensor.

14.5 General information

	Cause	Remedy
Sensor symbol flashes	<ul style="list-style-type: none"> – Calibration interval expired 	<ul style="list-style-type: none"> – Recalibrate the measuring system

**Cause**

- Batteries almost empty

Remedy

- Replace the batteries (see section 13.1 MAINTENANCE, page 89)

Display**Instrument does not react to keystroke****Cause**

- Operating condition undefined or EMC load unallowed

Remedy

- Processor reset:
Press the **<ENTER>** and **<On/Off>** key simultaneously

You want to know which software version is in the meter or IDS sensor**Cause**

- E. g., a question by the service department

Remedy

- Switch on the meter.
 - Open the menu, **<ENTER_ >** / *Storage & config / System / Service information*. The instrument data are displayed.
- or
- Connect the sensor.
Press softkey [**<F1>Info<F1>**] / *[More]* The sensor data are displayed (see section 4.1.5 SENSOR INFO, page 17)

15 Technical data

15.1 Measuring ranges, resolution, accuracy

Measuring ranges, accuracy	Parameter	Measuring range	Accuracy
	Air pressure (absolute)*	300 ... 1100 mbar	± 43 mbar

* Available only if a D.O. sensor is connected



Further data are given in the documentation of your sensor.

15.2 General data

Dimensions	Approx. 180 x 80 x 55 mm	
Weight	Approx. 0.4 kg	
Mechanical structure	Type of protection	IP 67
Electrical safety	Protective class	III
Test certificates	CE	
Ambient conditions	Storage	-25 °C ... +65 °C
	Operation	-10 °C ... +55 °C With the power pack connected: +5 °C ... +40 °C
	Admissible relative humidity	Yearly mean: < 75 % 30 days/year: 95 % Other days: 85 %
Power supply	Batteries	4 x 1.5 V alkali-manganese batteries, type AA
	Operational life	Approx. 150 h*

* The operational life is shorter if the display illumination is switched on permanently

USB interface (device)	Type	USB 1.1 USB-B (Device), PC
	Baud rate	Adjustable: 1200, 2400, 4800, 9600, 19200 Baud
	Data bits	8
	Stop bits	2
	Parity	None
	Handshake	RTS/CTS
	Cable length	Max. 3 m

Applicable directives and standards	EMC	EC directive 2004/108/EC EN 61326-1 EN 61000-3-2 EN 61000-3-3 FCC Class A
	Meter safety	EC directive 2006/95/EC EN 61010-1
	IP protection class	EN 60529
	RoHS	EU directive 2011/65/EU

FCC Class A Equipment Statement

Note: This equipment has been tested and found to comply with the limits for a Class A digital device, pursuant to Part 15 of the FCC Rules. These limits are designed to provide reasonable protection against harmful interference when the equipment is operated in a commercial environment. This equipment generates, uses, and can radiate radio frequency energy and, if not installed and used in accordance with the instruction manual, may cause harmful interference to radio communications. Operation of this equipment in a residential area is likely to cause harmful interference in which case the user will be required to correct the interference at his own expense. Changes or modifications not expressly approved by the manufacturer could void the user's authority to operate the equipment.

16 Firmware update

16.1 Firmware update for the meter Multi 3510 IDS

You can find available firmware update files for your meter on the Internet. With the "Firmware Update " program and a PC you can update the firmware of the Multi 3510 IDS to the newest version.

For the update you have to connect the meter to a PC.

For the update via the USB-B interface, the following is required:

- a free USB interface (virtual COM port) on the PC
- the driver for the USB interface (on the enclosed CD-ROM)
- the USB cable (included in the scope of delivery of the Multi 3510 IDS).

1. Install the downloaded firmware update on a PC.
An update folder is created in the Windows start menu.
If an update folder already exists for the meter (or meter type), the new data are displayed there.
2. In the windows start menu, open the update folder and start the firmware update program for the meter
3. Using the USB interface cable, connect the Multi 3510 IDS to a USB interface (virtual COM port) of the PC.
4. Switch on the Multi 3510 IDS.
5. In the firmware update program, start the update process with OK.
6. Follow the instructions of the firmware update program.
During the programming process, a corresponding message and a progress bar (in %) are displayed.
The programming process takes up to 15 minutes. A terminatory message is displayed after a successful programming process. The firmware update is completed.
7. Disconnect the Multi 3510 IDS from the PC.
The Multi 3510 IDS is ready for operation again.

After switching the meter off and on you can check whether the meter has taken over the new software version (see YOU WANT TO KNOW WHICH SOFTWARE VERSION IS IN THE METER OR IDS SENSOR, PAGE 95).

16.2 Firmware-Update for IDS Sensors

With the "Firmware Update" program and a PC you can update the firmware of an IDS sensor to the newest version.

You can find available firmware update files for your IDS sensor on the Internet.

For updating, connect the IDS sensor to the Multi 3510 IDS, and the Multi 3510 IDS to a PC.

For the update via the USB-B interface, the following is required:

- a free USB interface (virtual COM port) on the PC
- the driver for the USB interface (on the enclosed CD-ROM)
- the USB cable (included in the scope of delivery of the Multi 3510 IDS).

1. Install the downloaded firmware update on a PC.
An update folder is created in the Windows start menu.
If an update folder already exists for the sensor (or sensor type), the new data are displayed there.
2. In the windows start menu, open the update folder and start the firmware update program for the IDS sensor
3. Connect the IDS sensor to the Multi 3510 IDS meter.
4. Using the USB interface cable, connect the Multi 3510 IDS to a USB interface (virtual COM port) of the PC.
5. Switch on the Multi 3510 IDS.
6. In the firmware update program, start the update process with OK.
7. Follow the instructions of the firmware update program.
During the programming process, a corresponding message and a progress bar (in %) are displayed.
The programming process takes up to 5 minutes. A terminatory message is displayed after a successful programming process. The firmware update is completed.
8. Disconnect the Multi 3510 IDS from the PC.
Meter and sensor are ready for operation again.

After switching the meter off and on you can check whether the sensor has taken over the new software version (see YOU WANT TO KNOW WHICH SOFTWARE VERSION IS IN THE METER OR IDS SENSOR, PAGE 95).

17 Glossary

pH/ORP

Asymmetry	see zero point
Electromotive force of an electrode	The electromotive force U of the combination electrode is the measurable electromotive force of an electrode in a solution. It equals the sum of all the galvanic voltages of the combination electrode. Its dependency on the pH results in the electrode function, which is characterized by the parameters, slope and zero point.
Junction	The junction is a porous body in the housing wall of reference electrodes or electrolyte bridges. It arranges the electrical contact between two solutions and makes the electrolyte exchange more difficult. The expression, junction, is also used for ground or junction-less transitions.
ORP voltage (U)	The ORP is caused by oxidizing or reducing substances dissolved in water if these substances become effective on an electrode surface (e. g. a gold or platinum surface).
pH value	The pH value is a measure of the acidic or basic effect of an aqueous solution. It corresponds to the negative decadic logarithm of the molal hydrogen ions activity divided by the unit of the molality. The practical pH value is the value of a pH measurement.
Potentiometry	Name of a measuring technique. The signal (depending on the measured parameter) of the electrode is the electrical potential. The electrical current remains constant.
Slope	The slope of a linear calibration function.
Zero point	The zero point of a pH combination electrode is the pH value at which the electromotive force of the pH combination electrode at a specified temperature is zero. Normally, this is at 25 °C.

Conductivity

Cell constant, C	Characteristic quantity of a conductivity measuring cell, depending on the geometry.
Conductivity, χ	Short form of the expression, specific electrical conductivity. It corresponds to the reciprocal value of the resistivity. It is a measured value of the ability of a substance to conduct an electric current. In water analysis, the electrical conductivity is a dimension for the ionized substances in a solution.
Reference temperature	Fixed temperature value to compare temperature-dependent measured values. For conductivity measurements, the measured value is converted to a conductivity value at a reference temperature of 20 °C or 25 °C.
Resistivity, ρ	Short name for the electrolytic resistivity. It corresponds to the reciprocal value of the electrical conductivity.

Salinity	The absolute salinity S_A of seawater corresponds to the relationship of the mass of dissolved salts to the mass of the solution (in g/kg). In practice, this dimension cannot be measured directly. Therefore, the practical salinity according to IOT is used for oceanographic monitoring. It is determined by measuring the electrical conductivity.
Salt content	General designation for the quantity of salt dissolved in water.
Temperature coefficient	Value of the slope α of a linear temperature function. $\mathcal{R}_{T_{Ref}} = \mathcal{R}_{Meas} * \frac{1}{1 + \alpha * (T - T_{Ref})}$
Temperature compensation	Name of a function that considers the temperature influence on the measurement and converts it accordingly. Depending on the measured parameter to be determined, the temperature compensation functions in different ways. For conductimetric measurements, the measured value is converted to a defined reference temperature. For potentiometric measurements, the slope value is adjusted to the temperature of the test sample but the measured value is not converted.

Dissolved oxygen

D.O. partial pressure	Pressure caused by the oxygen in a gas mixture or liquid.
D.O. % saturation	Short name for the "relative D.O. saturation". Relation of the D.O. partial pressure in the test sample to the D.O. partial pressure of air at the current air pressure. Example: 100% means that the test sample and the ambient air have the same D.O. partial pressure – air and test sample are balanced.
OxiCal®	WTW name for a procedure to calibrate D.O. measuring systems in water vapor saturated air.
Salinity	The absolute salinity S_A of seawater corresponds to the relationship of the mass of dissolved salts to the mass of the solution (in g/kg). In practice, this dimension cannot be measured directly. Therefore, the practical salinity according to IOT is used for oceanographic monitoring. It is determined by measuring the electrical conductivity.
Salt content	General designation for the quantity of salt dissolved in water.
Slope (relative)	Designation used by WTW in the D.O. measuring technique. It expresses the relation of the slope value to the value of a theoretical reference sensor of the same construction type.

General information

Adjusting	To manipulate a measuring system so that the relevant value (e. g. the displayed value) differs as little as possible from the correct value or a value that is regarded as correct, or that the difference remains within the tolerance.
AutoRange	Name of the automatic selection of the measuring range.
Calibration	Comparing the value from a measuring system (e. g. the displayed value) to the correct value or a value that is regarded as correct. Often, this expression is also used when the measuring system is adjusted at the same time (see adjusting).
Measured parameter	The measured parameter is the physical dimension determined by measuring, e. g. pH, conductivity or D.O. concentration.
Measured value	The measured value is the special value of a measured parameter to be determined. It is given as a combination of the numerical value and unit (e. g. 3 m; 0.5 s; 5.2 A; 373.15 K).
Molality	Molality is the quantity (in Mol) of a dissolved substance in 1000 g solvent.
Reset	Restoring the original condition of all settings of a measuring system.
Resolution	Smallest difference between two measured values that can be displayed by a meter.
Stability control (AutoRead)	Function to control the measured value stability.
Standard solution	The standard solution is a solution where the measured value is known. It is used to calibrate a measuring system.
Temperature function	Name of a mathematical function expressing the temperature behavior of a test sample, a sensor or part of a sensor.
Test sample	Designation of the test sample ready to be measured. Normally, a test sample is made by processing the original sample. The test sample and original sample are identical if the test sample was not processed.

18 Index

A

Air calibration beaker	49
Automatic switch-off function	77
AutoRead	45, 54, 61
ORP	41
pH	26

B

Battery compartment	14, 89
---------------------------	--------

C

Calibration	
Conductivity	57
pH	28, 43
Calibration evaluation	
Conductivity	59
ISE	66
O ₂	52
pH	36
Calibration interval	
Conductivity	73, 75
O ₂	72
pH	70
Calibration points	
pH	34
calibration records	58
Cell constant	57
Comparison measurement (D.O.)	49
Connecting a PC	87
Connectors	17
Copyright	2

D

Dataset	85
Date and time	24
Default settings	
Measured parameter	78
System settings	80
Display	16

F

FDO® Check	47
Firmware update	99

I

Initial commissioning	13
Initialize	78
Interval for calibration	70

K

Keys	15
------------	----

M

Measured value display	21
Measurement accuracy	70
Measurement data storage	
Edit	84
Erase	84
Storage locations	86
Measurement dataset	85
Measuring	
Conductivity	54, 60
O ₂	44
ORP	41
pH	26
Menu for calibration and measurement settings	
Conductivity	73
O ₂	71
pH/ORP	67
Menus (navigation)	21
Messages	22

P

pH buffer sets	68
----------------------	----

R

Reset	78
-------------	----

S

Scope of delivery	13
Single-point calibration	
pH	29, 33
Slope	
pH	28
Slope, relative	49
Stability control	
automatic	77
Manual	26, 41, 45
Storage interval	82
Storing in memory	81
Automatic	82
Manual	81

T

Temperature compensation	56
--------------------------------	----

Temperature measurement	
Conductivity	.55
O2	.46
pH	.27, 43
Three-point calibration	
ISE	.65
pH	.30, 33
Transmitting data	.87
automatic	.88
manual	.88
Transmitting measured values	.87
Two-point calibration	
ISE	.64
pH	.29, 33
Z	
Zero point of pH electrode	.28

Xylem |'zīləm|

- 1) The tissue in plants that brings water upward from the roots;
- 2) a leading global water technology company.

We're a global team unified in a common purpose: creating advanced technology solutions to the world's water challenges. Developing new technologies that will improve the way water is used, conserved, and re-used in the future is central to our work. Our products and services move, treat, analyze, monitor and return water to the environment, in public utility, industrial, residential and commercial building services settings. Xylem also provides a leading portfolio of smart metering, network technologies and advanced analytics solutions for water, electric and gas utilities. In more than 150 countries, we have strong, long-standing relationships with customers who know us for our powerful combination of leading product brands and applications expertise with a strong focus on developing comprehensive, sustainable solutions.

For more information on how Xylem can help you, go to www.xylem.com.



Service and Returns:

Xylem Analytics Germany
Sales GmbH & Co. KG
WTW
Am Achalaich 11
82362 Weilheim
Germany

Tel.: +49 881 183-325

Fax: +49 881 183-414

E-Mail wtw.rma@xylem.com

Internet: www.xylemanalytics.com



Xylem Analytics Germany GmbH
Am Achalaich 11
82362 Weilheim
Germany

