

pH 3310

pH METER



a xylem brand

Copyright

© 2017 Xylem Analytics Germany GmbH
Printed in Germany.

pH 3310 - Contents

1	Overview	5
1.1	Keypad	6
1.2	Display	7
1.3	Connectors	8
2	Safety	9
2.1	Authorized use	10
2.2	General safety instructions	10
3	Commissioning	12
3.1	Scope of delivery	12
3.2	Initial commissioning	12
3.2.1	Inserting the batteries	12
3.2.2	Switching on the meter	13
3.2.3	Setting the date and time	13
4	Operation	14
4.1	Switching on the meter	14
4.2	General operating principles	15
4.2.1	Operating modes	15
4.2.2	Navigation	16
4.2.3	Navigation example 1: Setting the language	18
4.2.4	Example 2 on navigation: Setting the date and time	20
4.3	Sensor-independent settings	22
4.3.1	<i>System</i>	22
4.3.2	<i>Data storage</i>	23
4.3.3	<i>Automatic Stability control</i>	23
4.4	pH value / ORP voltage	24
4.4.1	General information	24
4.4.2	Measuring the pH value	25
4.4.3	Measuring the ORP	26
4.4.4	Settings for pH and ORP measurements	28
4.4.5	pH calibration	30
4.4.6	Calibration interval	35
4.4.7	Carrying out automatic calibration (AutoCal)	35
4.4.8	Carrying out a manual calibration (ConCal)	38
4.4.9	Displaying calibration records	42
4.4.10	Continuous measurement control (CMC function)	44

4.5	Data memory	45
4.5.1	Manual storage	45
4.5.2	Automatic storage at intervals	46
4.5.3	Editing the measurement data memory	49
4.5.4	Erasing the measurement data memory.	51
4.6	Transmitting data (USB interface)	52
4.6.1	Options for data transmission	52
4.6.2	Connecting a PC	53
4.7	MultiLab Importer.	53
4.8	Reset	54
4.8.1	Resetting the measurement settings	54
4.8.2	Resetting the system settings.	55
5	Maintenance, cleaning, disposal	56
5.1	Maintenance	56
5.1.1	Replacing the batteries	56
5.2	Cleaning.	57
5.3	Packing	57
5.4	Disposal.	57
6	What to do if...	58
7	Technical data	61
7.1	General data	61
7.2	Measuring ranges, resolution, accuracy	62
8	Lists	63
9	Firmware update	67

1 Overview

The compact pH 3310 precision pH meter enables you to perform pH measurements rapidly and reliably. The pH 3310 provides the maximum degree of operating comfort, reliability and measuring certainty for all applications.





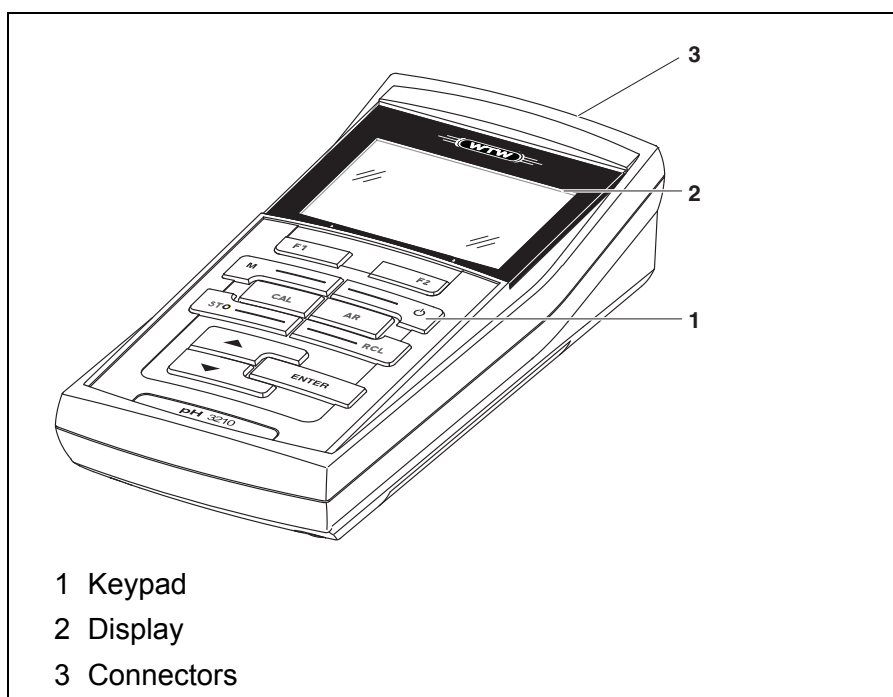

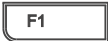
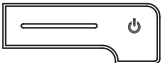

The proven calibration procedures and automatic stability control function (AR) support your work with the pH meter.

The USB interface can be used for data transmission to a PC and for software updates of the meter.



1.1 Keypad

In this operating manual, keys are indicated by brackets <...> .
 The key symbol (e.g. <ENTER>) generally indicates a short keystroke (under 2 sec) in this operating manual. A long keystroke (approx. 2 sec) is indicated by the underscore behind the key symbol (e.g. <ENTER__>).

	<F1>: <F1__>:	<F1>/[Menu]: Opens the menu for measurement settings <F1__>/[Menu]: Opens the menu for system settings
	<On/Off>:	Switches the meter on or off
	<M>:	Selects the measured parameter
	<CAL>: <CAL__>:	Calls up the calibration procedure Displays the calibration data
	<STO>:	Saves a measured value manually
	<RCL>:	Displays the manually stored measured values
	<▲>:	Increments values, scrolls
	<▼>:	Decrements values, scrolls
	<ENTER>: <ENTER__>:	Opens the menu for measurement settings / confirms entries Opens the menu for system settings
	<AR>	Freezes the measured value (HOLD function) Switches the AutoRead measurement on or off

1.2 Display

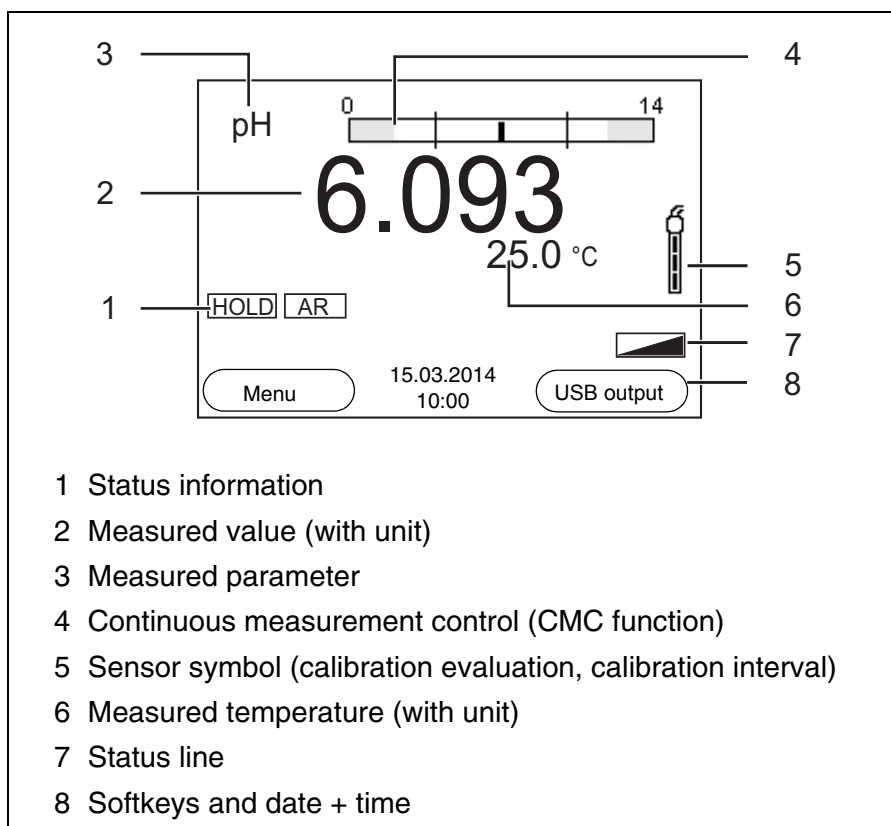

Function display indicators

AutoCal e.g. TEC	Calibration with automatic buffer recognition, e.g. with the buffer set: Technical buffers
ConCal	Calibration with any buffers
Error	An error occurred during calibration
LoBat	Batteries are almost empty
AR	Stability control (AutoRead) is active
HOLD	Measured value is frozen (<AR> key)
	Batteries are almost empty

1.3 Connectors

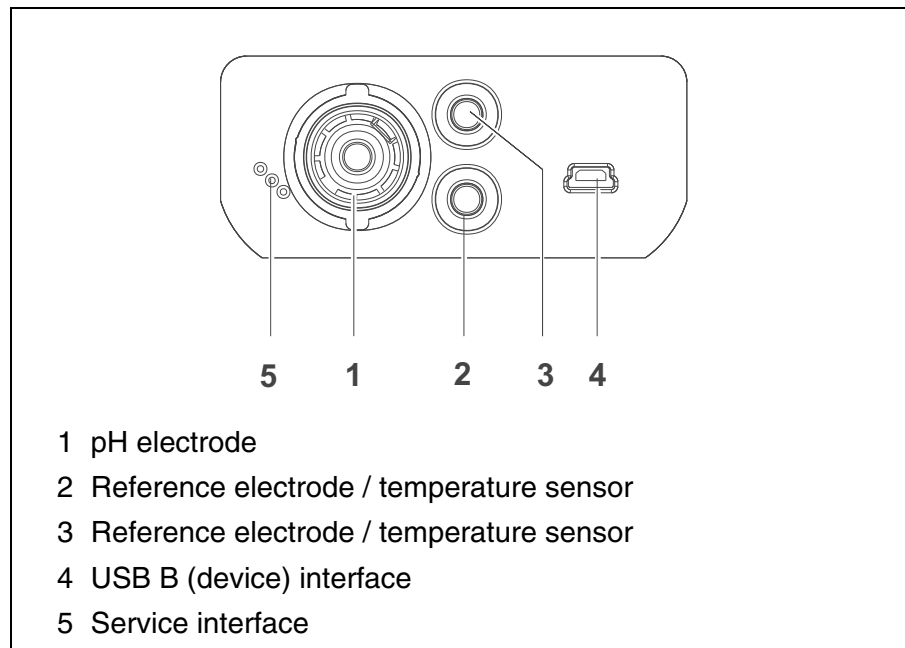

Caution

Only connect sensors to the meter that cannot return any voltages or currents that are not allowed ($>$ SELV and $>$ current circuit with current limiting).

Almost all customary sensors fulfill these conditions.

2 Safety

This operating manual contains basic instructions that you must follow during the commissioning, operation and maintenance of the meter. Consequently, all responsible personnel must read this operating manual before working with the meter.

The operating manual must always be available within the vicinity of the meter.

Target group

The meter was developed for work in the field and in the laboratory. Thus, we assume that, as a result of their professional training and experience, the operators will know the necessary safety precautions to take when handling chemicals.

Safety instructions

Safety instructions in this operating manual are indicated by the warning symbol (triangle) in the left column. The signal word (e.g. "Caution") indicates the level of danger:



Warning

indicates instructions that must be followed precisely in order to avoid possibly great dangers to personnel.



Caution

indicates instructions that must be followed precisely in order to avoid the possibility of slight injuries or damage to the instrument or the environment.

Further notes



Note

indicates notes that draw your attention to special features.

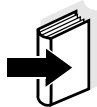

Note

indicates cross-references to other documents, e.g. operating manuals.

**Function and
operational safety****2.1 Authorized use**

This meter is authorized exclusively for pH and ORP measurements in a laboratory or field environment.

The technical specifications as given in chapter 7 TECHNICAL DATA must be observed. Only the operation and running of the meter according to the instructions given in this operating manual is authorized.

Any other use is considered **unauthorized**.

2.2 General safety instructions

This meter is constructed and tested in compliance with the IEC 1010 safety regulations for electronic measuring instruments.

It left the factory in a safe and secure technical condition.

The smooth functioning and operational safety of the meter can only be guaranteed if the generally applicable safety measures and the specific safety instructions in this operating manual are followed during operation.

The smooth functioning and operational safety of the meter can only be guaranteed under the environmental conditions that are specified in chapter 7 TECHNICAL DATA.

If the meter was transported from a cold environment to a warm environment, the formation of condensate can lead to the faulty functioning of the meter. In this event, wait until the temperature of the meter reaches room temperature before putting the meter back into operation.

**Caution**

The meter is only allowed to be opened by authorized personnel.

Safe operation

If safe operation is no longer possible, the meter must be taken out of service and secured against inadvertent operation!

Safe operation is no longer possible if the meter:

- has been damaged in transport
- has been stored under adverse conditions for a lengthy period of time
- is visibly damaged
- no longer operates as described in this manual.

If you are in any doubt, please contact the supplier of the meter.

Obligations of the purchaser

The purchaser of this meter must ensure that the following laws and guidelines are observed when using dangerous substances:

- EEC directives for protective labor legislation
- National protective labor legislation
- Safety regulations
- Safety datasheets of the chemical manufacturers.

**Caution**

In addition to the safety instructions mentioned here, also follow the safety instructions of the sensors used.

The operating manuals of the sensors are available on the supplied CD and on the Internet under www.WTW.com.

3 Commissioning

3.1 Scope of delivery

- pH meter pH 3310
- 4 batteries 1.5 V Mignon type AA
- Short instructions
- CD-ROM with
 - USB drivers
 - detailed operating manual
 - Software MultiLab Importer

3.2 Initial commissioning

Perform the following activities:

- Insert the supplied batteries
- Switch on the meter
- Set the date and time

3.2.1 Inserting the batteries

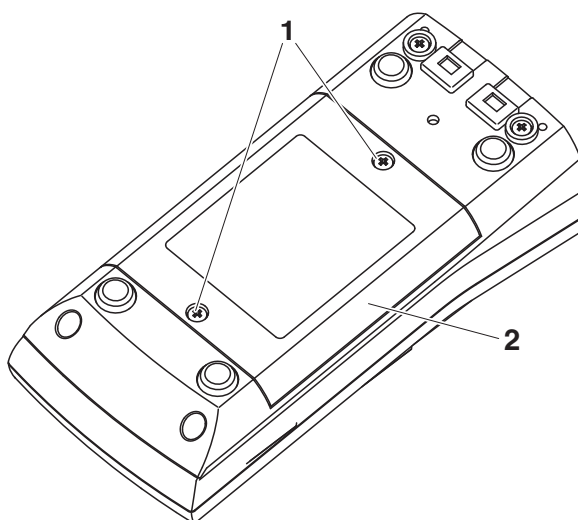

- | | |
|---|---|
| 1 | Unscrew the four screws (1) on the underside of the meter. |
| 2 | Open the battery compartment (2) on the underside of the meter. |

**Caution**

Make sure that the poles of the batteries are positioned correctly. The \pm signs on the batteries must correspond to the \pm signs in the battery compartment.

**Note**

Alternatively, you can also use Ni-MH rechargeable batteries (type Mignon AA). In order to charge the batteries, an external charging device is required.

3	Place four batteries (type Mignon AA) in the battery compartment.
4	Close the battery compartment.

3.2.2 Switching on the meter

1	<p>Press the <On/Off> key. The meter performs a self-test. The display shows the manufacturer's logo while the self-test is being performed. Subsequently, the meter switches to the measuring mode (measured value display).</p>
---	---

**Note**

The meter has an energy saving feature to avoid unnecessary battery depletion. The energy saving feature switches off the meter if no key is pressed during the adjusted interval. (How to set the switch-off interval, see section 4.3.1).

3.2.3 Setting the date and time

1	See section 4.2.4
---	-------------------

4 Operation

4.1 Switching on the meter

Switching on

Press the <On/Off> key.

The meter performs a self-test.

The display shows the manufacturer's logo while the self-test is being performed.

The measured value display appears.

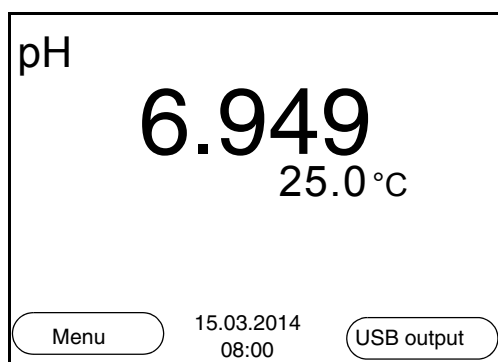

Switching off

Press the <On/Off> key.

Automatic switch-off function

The instrument has an automatic switch-off function in order to save the batteries (see section 4.3.1). The automatic switch-off function switches off the meter if no key is pressed for an adjustable period.

The automatic switch-off function is not active

- if the communication cable is connected
- if the *Autom. storage* function is active, or with automatic data transmission

Display illumination

The meter automatically switches off the display illumination if no key is pressed for 30 seconds. The illumination is switched on with the next keystroke again.

You can also generally switch the display illumination on or off (see section 4.3.1).

4.2 General operating principles

This section contains basic information on the operation of the pH 3310.

Operating elements, display

An overview of the operating elements and the display is given in section 1.1 and section 1.2.

Operating modes, navigation

An overview of the operating modes and navigation of the pH 3310 is given in section 4.2.1 and section 4.2.2.

4.2.1 Operating modes

The instrument has the following operating modes:

- Measuring
The measurement data of the connected sensor are shown in the measured value display
- Calibration
The course of a calibration with calibration information, functions and settings is displayed
- Storing in memory
The meter stores the measurement data manually or automatically
- Transmitting data
The meter transmits measurement data and calibration records to the USB interface automatically or manually.
- Setting
The system menu or a sensor menu with submenus, settings and functions is displayed

4.2.2 Navigation

Measured value display

In the measured value display, you can

- open the menu for calibration and measurement settings with <F1> (short keystroke)
- open the system menu with the sensor-independent settings by pressing <F1>Storage & config for a <F1 __>long keystroke, approx. 2 s).
- change the display in the selected measuring screen (e. g. pH <-> mV) by pressing <M>.

Menus and dialogs

The menus for settings and dialogs in procedures contain further sub-elements. The selection is made with the <▲><▼> keys. The current selection is displayed with a frame.

- Submenus

The name of the submenu is displayed at the upper edge of the frame. Submenus are opened by confirming with <ENTER>. Example:

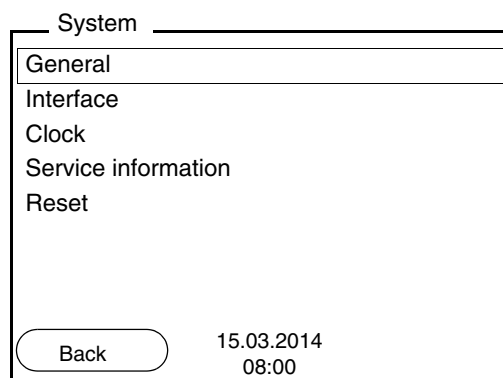

- Settings

Settings are indicated by a colon. The current setting is displayed on the right-hand side. The setting mode is opened with <ENTER>. Subsequently, the setting can be changed with <▲><▼> and <ENTER>. Example:

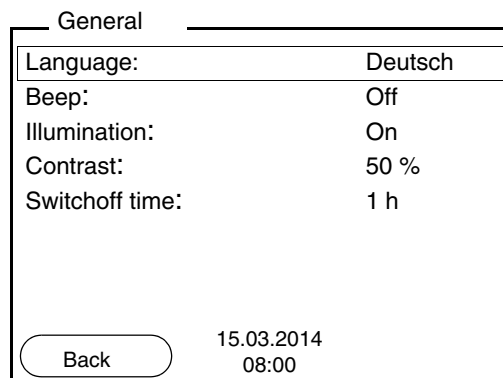

- **Functions**

Functions are designated by the name of the function. They are immediately carried out by confirming with **<ENTER>**.

Example: Display the *Calibration record* function.

pH

Calibration record	
Calibration data storage	
Buffer:	TEC
One point calibration:	Yes
Calibration interval:	7 d
Unit for slope:	mV/pH
i 2.00 4.01 7.00 10.01 (25 °C)	
Back	15.03.2014 08:00

Messages

Information is marked by the **i** symbol. It cannot be selected. Example:

pH

Calibration record	
Calibration data storage	
Buffer:	TEC
One point calibration:	Yes
Calibration interval:	7 d
Unit for slope:	mV/pH
i 2.00 4.01 7.00 10.01 (25 °C)	
Back	15.03.2014 08:00



Note

The principles of navigation are explained in the two following sections by reference of examples:

- Setting the language (section 4.2.3)
- Setting the date and time (see section 4.2.4).

4.2.3 Navigation example 1: Setting the language

- 1 Press the **<On/Off>** key.
The measured value display appears.
The instrument is in the measuring mode.

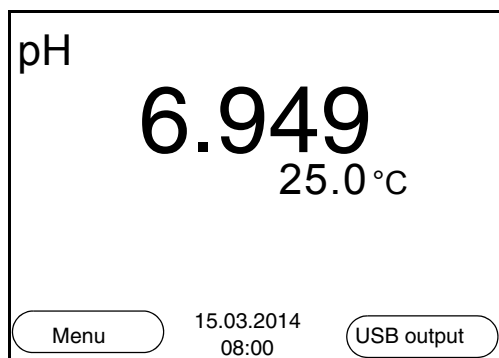

- 2 Using **<F1__>/[Menu]**, open the *Storage & config* menu.
The instrument is in the setting mode.

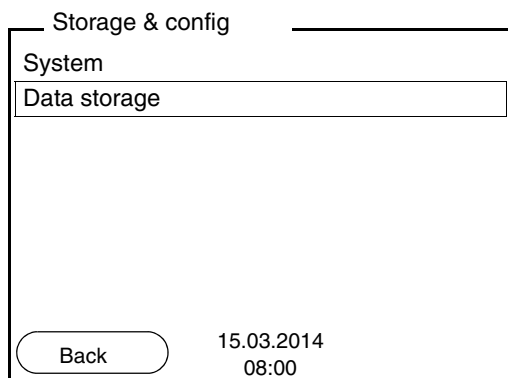

- 3 Select the *System* submenu with **<▲><▼>**.
The current selection is displayed with a frame.
- 4 Open the *System* submenu with **<ENTER>**.

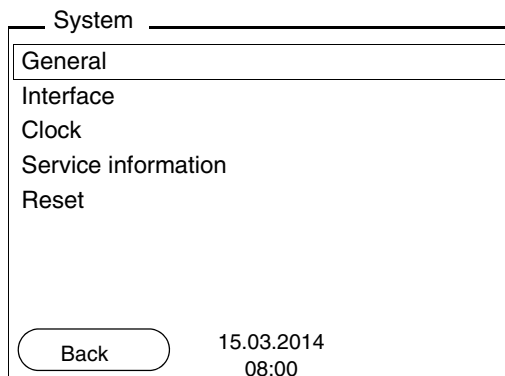

5 | Select the *General* submenu with <▲><▼>. The current selection is displayed with a frame.

6 | Open the *General* submenu with <ENTER>.

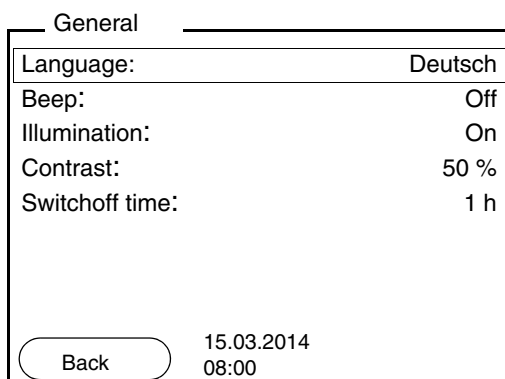

7 | Open the setting mode for the *Language* with <ENTER>.

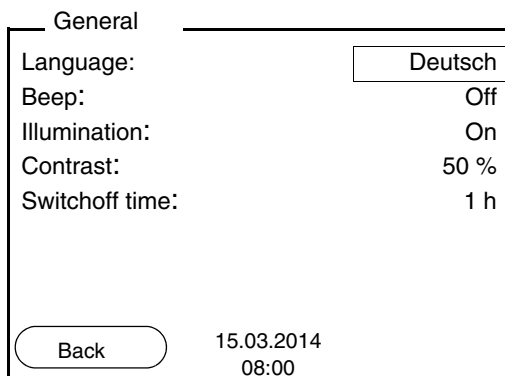

8 | Select the required language with <▲><▼>.

- 9 | Confirm the setting with **<ENTER>**.
The meter switches to the measuring mode.
The selected language is active.

4.2.4 Example 2 on navigation: Setting the date and time

The meter has a clock with a date function. The date and time are indicated in the status line of the measured value display.

When storing measured values and calibrating, the current date and time are automatically stored as well.

The correct setting of the date and time and date format is important for the following functions and displays:

- Current date and time
- Calibration date
- Identification of stored measured values.

Therefore, check the time at regular intervals.



Note

After a fall of the supply voltage (empty batteries), the date and time are reset.

Setting the date, time and date format

The date format can be switched from the display of day, month, year (*dd.mm.yyyy*) to the display of month, day, year (*mm/dd/yyyy* or *mm.dd.yyyy*).

1	In the measured value display: Using <F1 __>/[Menu] , open the <i>Storage & config</i> menu. The instrument is in the setting mode.
2	Select and confirm the <i>System / Clock</i> menu with <▲><▼> and <ENTER> . The setting menu for the date and time opens up.
3	Select and confirm the <i>Time</i> menu with <▲><▼> and <ENTER> . The hours are highlighted.

Clock

Date format:	dd.mm.yyyy
Date:	15.03.2014
Time:	14:53:40
<div style="display: flex; justify-content: space-between; align-items: center;"> Back 15.03.2014 08:00 </div>	

4	Change and confirm the setting with <▲><▼> and <ENTER>. The minutes are highlighted.
5	Change and confirm the setting with <▲><▼> and <ENTER>. The seconds are highlighted.
6	Change and confirm the setting with <▲><▼> and <ENTER>. The time is set.
7	If necessary, set the <i>Date</i> and <i>Date format</i> . The setting is made similarly to that of the time.
8	If necessary, select and set the <i>Date</i> with <▲><▼> and <ENTER>.
9	To make further settings, switch to the next higher menu level with <F1>/[Back]. or Switch to the measured value display with <M>. The instrument is in the measuring mode.

4.3 Sensor-independent settings

The *Storage & config* menu comprises the following settings:

- *System* (see section 4.3.1).
- *Data storage* (see section 4.3.2)

4.3.1 System

Overview

The following sensor-independent meter characteristics can be adjusted in the *Storage & config/System* menu:

- Menu language
- Beep on keystroke
- Illumination
- Display contrast
- Interval of the automatic switch-off function
- Data interface
- Clock and date function
- Reset of all sensor-independent system settings to the default condition

Settings

To open the *Storage & config* menu, press the <F1__>/[Menu] key in the measured value display. After completing the settings, switch to the measured value display with <M>.

Menu item	Setting	Explanation
<i>System / General / Language</i>	<i>Deutsch</i> <i>English</i> (more)	Selects the menu language
<i>System / General / Beep</i>	<i>On</i> <i>Off</i>	Switches on/off the beep on keystroke
<i>System / General / Illumination</i>	<i>Auto</i> <i>On</i> <i>Off</i>	Switches the display illumination on/off
<i>System / General / Contrast</i>	0 ... 100 %	Changes the display contrast
<i>System / General / Switchoff time</i>	10 min ... 24 h	Adjusts the switch-off time
<i>System / Interface / Baud rate</i>	1200, 2400, 4800, 9600, 19200	Baud rate of the data interface

Menu item	Setting	Explanation
<i>System / Interface / Output format</i>	<i>ASCII</i> <i>CSV</i>	Output format for data transmission For details, see section 4.6
<i>System / Interface / Decimal separator</i>	<i>Dot (xx.x)</i> <i>Comma (xx,x)</i>	Decimal separator
<i>System / Interface / Output header</i>		Output of a header for <i>Output format: CSV</i>
<i>System / Clock</i>	<i>Time</i> <i>Date</i> <i>Date format</i>	Settings of time and date. For details, see section 4.2.4
<i>System / Service information</i>		Hardware version and software version of the meter are displayed.
<i>System / Reset</i>	-	Resets the system settings to the default values. For details, see section 4.8.2

4.3.2 Data storage

This menu contains all functions to display, edit and erase stored measured values and calibration records.



Note

Detailed information on the memory functions of the pH 3310 is given in section 4.5.

4.3.3 Automatic Stability control

The automatic *Stability control* (AutoRead) function continuously checks the stability of the measurement signal. The stability has a considerable impact on the reproducibility of measured values.

You can activate or switch off the automatic *Stability control* function (see section 4.4.4).

The measured parameter flashes on the display

- as soon as the measured value is outside the stability range
- when you switch over between the measured parameters with <M>.
- when the automatic *Stability control* is switched off.

4.4 pH value / ORP voltage

4.4.1 General information

You can measure the following parameters:

- pH value []
- ORP [mV]



Temperature measurement

Attention

When a grounded PC is connected, measurements cannot be performed in grounded media as incorrect values would result. The USB-A (Device) is not galvanically isolated.

For reproducible pH measurements, it is essential to measure the temperature of the test sample.

You have the following options to measure the temperature:

- Automatic measurement of the temperature by the temperature sensor (NTC30 or Pt1000) integrated in electrode.
- Measurement by an external temperature sensor.
- Manual determination and input of the temperature.

The measuring instrument recognizes whether a suitable sensor is connected and automatically switches on the temperature measurement.

The display of the temperature indicates the active temperature measuring mode:

Temperature sensor	Resolution of the temp. display	Mode
yes	0.1 °C	Automatic with temperature sensor
-	1 °C	Manual

Preparatory activities

Perform the following preparatory activities when you want to measure:

1	Connect a pH or ORP electrode to the meter. The pH measuring window is displayed.
2	If necessary, select the pH or mV display with <M>.
3	Adjust the temperature of the solutions and measure the current temperature if the measurement is made without a temperature sensor.

- 4 | Calibrate or check the meter with the electrode.

4.4.2 Measuring the pH value

- | | |
|---|--|
| 1 | Perform the preparatory activities according to section 4.4.1. |
| 2 | Immerse the pH electrode in the test sample. |

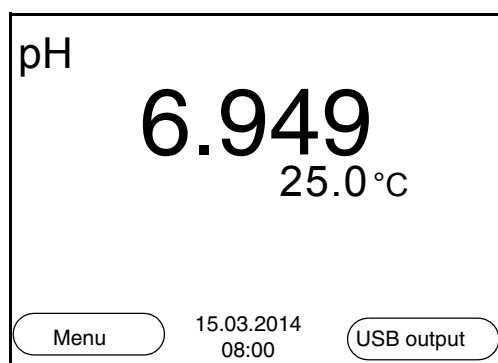

- | | |
|---|---|
| 3 | Select the pH or mV display with <M> . |
|---|---|

Stability control (AutoRead)

The stability control function (AutoRead) continually checks the stability of the measurement signal. The stability has a considerable impact on the reproducibility of measured values.

The measured parameter flashes on the display

- as soon as the measured value is outside the stability range
- when the automatic *Stability control* is switched off.

You can start the *Stability control* manually at any time, irrespective of the setting for automatic *Stability control* (see page 23) in the *Measurement* menu.

- | | |
|---|--|
| 1 | Freeze the measured value with <AR> .
The [HOLD] status indicator is displayed.
The HOLD function is active. |
| 2 | Using <ENTER> , activate the <i>Stability control</i> function manually.
The [AR] status indicator appears while the measured value is assessed as not stable. A progress bar is displayed and the display of the measured parameter flashes.
The [HOLD][AR] status indicator appears as soon as a stable measured value is recognized. |



Note

You can prematurely terminate the *Stability control* function manually with **<ENTER>** at any time. If the *Stability control* function is prematurely terminated, the current measurement data are output to the interface without the AutoRead info.

- | | |
|---|--|
| 3 | Using <ENTER> , start a further measurement with stability control.
or
Release the frozen measured value again with <AR> or <M> . The [AR] status display disappears. The display switches back to the previous indication. |
|---|--|

Criteria for a stable measured value

The *Stability control* function checks whether the measured values are stable within the monitored time interval.

Measured parameter	Time interval	Stability during the time interval
pH value	15 seconds	Δ : better than 0.01 pH
Temperature	15 seconds	Δ : better than 0.5 °C

The minimum duration until a measured value is assessed as stable is the monitored time interval. The actual duration is mostly longer.

4.4.3 Measuring the ORP



Note

ORP electrodes are not calibrated. However, you can check ORP electrodes using a test solution.

- | | |
|---|--|
| 1 | Perform the preparatory activities according to section 4.4.1. |
| 2 | Submerge the ORP electrode in the sample. |

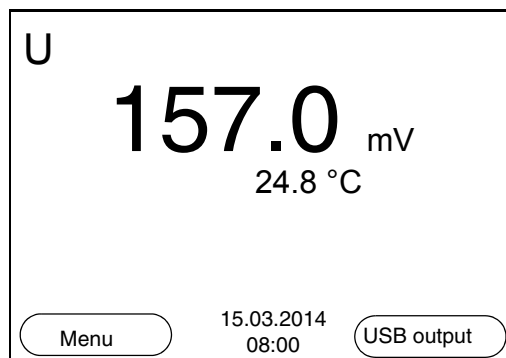

- 3 | Select the mV display with **<M>**.

Stability control (AutoRead)

The stability control function (AutoRead) continually checks the stability of the measurement signal. The stability has a considerable impact on the reproducibility of measured values.

The measured parameter flashes on the display

- as soon as the measured value is outside the stability range
- when the automatic *Stability control* is switched off.

You can start the *Stability control* manually at any time, irrespective of the setting for automatic *Stability control* (see page 23) in the *Measurement* menu.

- 1 | Freeze the measured value with **<AR>**.
The [HOLD] status indicator is displayed.
The HOLD function is active.
- 2 | Using **<ENTER>**, activate the *Stability control* function manually.
The [AR] status indicator appears while the measured value is assessed as not stable. A progress bar is displayed and the display of the measured parameter flashes.
The [HOLD][AR] status indicator appears as soon as a stable measured value is recognized.



Note

You can prematurely terminate the *Stability control* function manually with **<ENTER>** at any time. If the *Stability control* function is prematurely terminated, the current measurement data are output to the interface without the AutoRead info.

3 Using <ENTER>, start a further measurement with stability control.
or
Release the frozen measured value again with <AR> or <M>. The [AR] status display disappears. The display switches back to the previous indication.

Criteria for a stable measured value

The *Stability control* function checks whether the measured values are stable within the monitored time interval.

Measured parameter	Time interval	Stability during the time interval
ORP	15 seconds	Δ : better than 0.3 mV
Temperature	15 seconds	Δ : better than 0.5 °C

The minimum duration until a measured value is assessed as stable is the monitored time interval. The actual duration is mostly longer.

4.4.4 Settings for pH and ORP measurements

Overview

The following settings are possible for pH and ORP measurements:

- Resolution
- Calibration interval
- Buffers for calibration
- Unit of the temperature
- Automatic stability control
- Unit for slope
- Calibration record (display)

Settings

The settings are made in the menu for calibration and measurement settings of the pH/ORP measurement. To open the settings, display the required parameter in the measured value display and press the <F1>/[menu] or <ENTER> key. After completing the settings, switch to the

measured value display with <M>.

Menu item	Possible setting	Explanation
<i>Calibration / Calibration record</i>	-	Displays the calibration record of the last calibration.
<i>Calibration / Buffer</i>	TEC NIST/DIN ConCal ...	Buffer sets to be used for pH calibration. More buffers and details, see section 4.4.5.
<i>Calibration / Calibration data storage</i>	-	Displays the last calibration records.
<i>Calibration / One point calibration</i>	Yes No	Quick calibration with 1 buffer
<i>Calibration / Calibration interval</i>	1 ... 999 d	<i>Calibration interval</i> for the pH electrode (in days). The meter reminds you to calibrate regularly by the flashing sensor symbol in the measuring screen.
<i>Calibration / Unit for slope</i>	mV/pH %	Unit of the slope. The % display refers to the Nernst slope of -59.2 mV/pH (100 x determined slope/Nernst slope).
<i>Man. temperature</i>	-25 ... +130 °C	Entry of the manually determined temperature. For measurements without temperature sensor only.
<i>Temperature unit</i>	°C °F	Temperature unit, degrees Celsius or degrees Fahrenheit. All temperature values are displayed with the selected unit.
<i>Resolution pH</i>	0.001 0.01 0.1	Resolution of the pH display:
<i>Resolution mV</i>	0.1 1	Resolution of the mV display:

Menu item	Possible setting	Explanation
<i>Stability control</i>	<i>On / Off</i>	Switches on or off the automatic stability control during measurement (see section 4.3.3)
<i>Reset</i>	-	Resets all sensor settings to the delivery condition (see section 4.8.1).

4.4.5 pH calibration

Why calibrate?

pH electrodes age. This changes the zero point (asymmetry) and slope of the pH electrode. As a result, an inexact measured value is displayed. Calibration determines and stores the current values of the zero point and slope of the electrode.

Thus, you should calibrate at regular intervals.

When do you have to calibrate?

- After connecting another combination electrode
- When the calibration interval has expired

Buffer sets for calibration

You can use the buffer sets quoted in the table for an automatic calibration. The pH values are valid for the specified temperature values. The temperature dependence of the pH values is taken into consideration during calibration.

No.	Buffer set *	pH values	at
1	ConCal	Any	Any
2	NIST/DIN DIN buffers according to DIN 19266 and NIST Traceable Buffers	1.679 4.006 6.865 9.180 12.454	25 °C
3	TEC WTW Technical buffers	2.000 4.010 7.000 10.011	25 °C
4	Merck 1*	4.000 7.000 9.000	20°C

No.	Buffer set *	pH values	at
5	Merck 2 *	1.000 6.000 8.000 13.000	20°C
6	Merck 3 *	4.660 6.880 9.220	20°C
7	Merck 4 *	2.000 4.000 7.000 10.000	20°C
8	Merck 5 *	4.010 7.000 10.000	25 °C
9	DIN 19267	1.090 4.650 6.790 9.230	25 °C
10	Mettler Toledo USA *	1.679 4.003 7.002 10.013	25 °C
11	Mettler Toledo EU *	1.995 4.005 7.002 9.208	25 °C
12	Fisher *	2.007 4.002 7.004 10.002	25 °C
13	Fluka BS *	4.006 6.984 8.957	25 °C
14	Radiometer *	1.678 4.005 7.000 9.180	25 °C
15	Baker *	4.006 6.991 10.008	25 °C

No.	Buffer set *	pH values	at
16	Metrohm *	3.996 7.003 8.999	25 °C
17	Beckman *	4.005 7.005 10.013	25 °C
18	Hamilton Duracal *	4.005 7.002 10.013	25 °C
19	Precisa *	3.996 7.003 8.999	25 °C
20	<i>Reagecon TEC</i> *	2.000 4.010 7.000 10.000	25 °C
21	<i>Reagecon 20</i> *	2.000 4.000 7.000 10.000 13.000	20°C
22	<i>Reagecon 25</i> *	2.000 4.000 7.000 10.000 13.000	25 °C
23	Chemsolute *	4.000 7.000 10.000	20°C
24	USABlueBook *	4.000 7.000 10.000	20°C

* Brand names or trade names are trademarks of their respective owners protected by law.

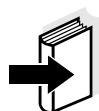

Note

The buffers are selected in the menu, pH / <F1>/[Menu] / Calibration / Buffer (see page 28).

Calibration points

Calibration can be performed using one to five buffer solutions in any order (single-point to five-point calibration). The meter determines the

following values and calculates the calibration line as follows:

	Determined values	Displayed calibration data
1-point	<i>Asy</i>	<ul style="list-style-type: none"> ● Zero point = <i>Asy</i> ● Slope = Nernst slope (-59.2 mV/pH at 25 °C)
2-point	<i>Asy</i> <i>Slp.</i>	<ul style="list-style-type: none"> ● Zero point = <i>Asy</i> ● Slope = <i>Slp.</i>
3-point to 5-point	<i>Asy</i> <i>Slp.</i>	<ul style="list-style-type: none"> ● Zero point = <i>Asy</i> ● Slope = <i>Slp.</i> <p>The calibration line is calculated by linear regression.</p>



Stability control

Note

You can display the slope in the units, mV/pH or % (see page 28).

The calibration procedure automatically activates the stability control function. The current measurement with stability control can be terminated at any time (accepting the current value).

Calibration record

The new calibration values are displayed when the calibration is finished.

Display calibration data and output to interface

You can have the data of the last calibration displayed (see page 42). Subsequently, you can transmit the displayed calibration data to the interface, e.g. to a PC, with the **<F2>**/*[USB output]* key.



Note

The calibration record is automatically transmitted to the interface after calibrating.

Sample record

```

30.03.2014 15:55
pH 3310
Ser. no. 08502113

CALIBRATION pH

AutoCal TEC
Buffer 1          4.01
Buffer 2          7.00
Buffer 3          10.01
Voltage 1         184.0 mV
Voltage 2         3.0 mV
Voltage 3         -177.0 mV
Temperatur 1     24.0 °C
Temperatur 2     24.0 °C
Temperatur 3     24.0 °C
Slope            -60.2 mV/pH
Asymmetry        4.0 mV
Sensor           +++

etc...
    
```

Calibration evaluation

After calibrating, the meter automatically evaluates the calibration. The zero point and slope are evaluated separately. The worse evaluation of both is taken into account. The evaluation appears on the display and in the calibration record.

Display	Calibration record	Zero point [mV]	Slope [mV/pH]
	+++	-15 ... +15	-60,5 ... -58
	++	-20 ... +20	-58 ... -57
	+	-25 ... +25	-61 ... -60.5 or -57 ... -56
	-	-30 ... +30	-62 ... -61 or -56 ... -50
Clean the electrode according to the electrode operating manual			
Error	Error	< -30 or > 30	... -62 or ... -50
Eliminate the error according to chapter 6 WHAT TO DO IF... (page 58)			

Preparatory activities

Perform the following preparatory activities when you want to calibrate:

1	Connect the pH electrode to the meter. The pH measuring window is displayed.
2	Keep the buffer solutions ready. Adjust the temperature of the buffer solutions, or measure the current temperature, if you measure without a temperature sensor.

4.4.6 Calibration interval

The calibration evaluation is displayed as a sensor symbol.

The sensor symbol flashes after the adjusted calibration interval has expired. It is still possible to measure.

**Note**

To ensure the high measuring accuracy of the measuring system, calibrate after the calibration interval has expired.

Setting the calibration interval

The calibration interval is set to 7 days (d7) in the factory. You can change the interval (1 ... 999 days):

1	Open the menu for measurement settings with <F1>/[Menu].
2	In the <i>Calibration / Calibration interval</i> menu, set the calibration interval with <▲><▼>.
3	Confirm the setting with <ENTER>.
4	Quit the menu with <M>.

4.4.7 Carrying out automatic calibration (AutoCal)

Make sure that in the sensor menu, *Buffer* menu, the buffer set is correctly selected (see page 28).

Use any one to five buffer solutions of the selected buffer set in ascending or descending order.

Below, calibration with Technical buffers (TEC) is described. When other buffer sets are used, other nominal buffer values are displayed. Apart from that, the procedure is identical.

**Note**

If single-point calibration was set in the menu, the calibration procedure

is automatically finished with the measurement of buffer solution 1 and the calibration record is displayed.

- | | |
|---|--|
| 1 | In the measured value display, select the measured parameter pH or mV with <M> . |
| 2 | Start the calibration with <CAL> .
The calibration display for the first buffer appears (voltage display). |

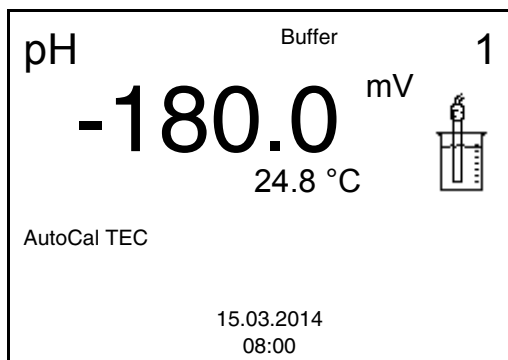

- | | |
|---|--|
| 3 | Thoroughly rinse the electrode with deionized water. |
| 4 | Immerse the electrode in buffer solution 1. |
| 5 | When measuring without temperature sensor:
Measure the temperature of the buffer manually and enter it with <▲><▼> . |
| 6 | Start the measurement with <ENTER> .
The measured value is checked for stability (stability control).
The [AR] status indicator is displayed. The measured parameter flashes. |

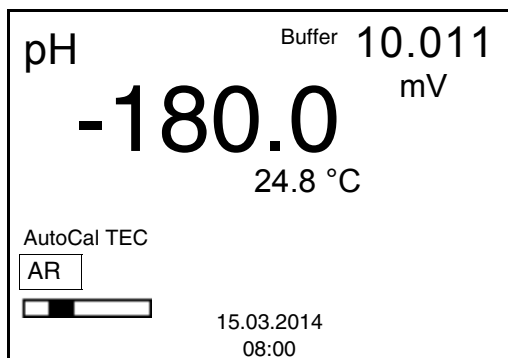

- | | |
|---|--|
| 7 | Wait for the end of the measurement with stability control or accept the calibration value with <ENTER> .
The calibration display for the next buffer appears (voltage display). |
|---|--|

- 8 | If necessary, finish the calibration procedure as a single-point calibration with **<M>**.
The calibration record is displayed.



Note
For **single-point calibration**, the instrument uses the Nernst slope (-59.2 mV/pH at 25 °C) and determines the zero point of the electrode.

Continuing with two-point calibration

- 9 | Thoroughly rinse the electrode with deionized water.
- 10 | Immerse the electrode in buffer solution 2.
- 11 | When measuring without temperature sensor:
Measure the temperature of the buffer manually and enter it with **<▲><▼>**.
- 12 | Start the measurement with **<ENTER>**.
The measured value is checked for stability (stability control).
The [AR] status indicator is displayed. The measured parameter flashes.

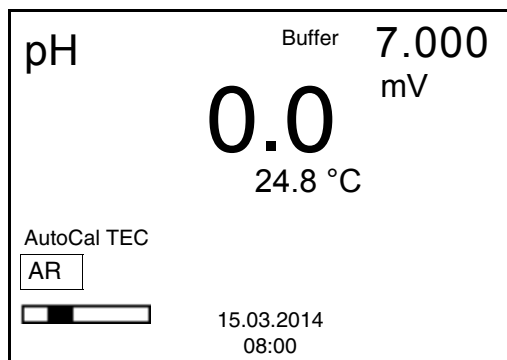

- 13 | Wait for the measurement with stability control to be completed or terminate the stability control and take over the calibration value with **<ENTER>**.
The calibration display for the next buffer appears (voltage display).
- 14 | If necessary, finish the calibration procedure as a two-point calibration with **<M>**.
The calibration record is displayed.

Continuing with three-to five-point calibration

- 15 | Thoroughly rinse the electrode with deionized water.
- 16 | Immerse the electrode in the next buffer solution.

- | | |
|----|--|
| 17 | When measuring without temperature sensor:
Measure the temperature of the buffer manually and enter it with <▲><▼>. |
| 18 | Start the measurement with <ENTER>.
The measured value is checked for stability (stability control).
The [AR] status indicator is displayed. The measured parameter flashes. |

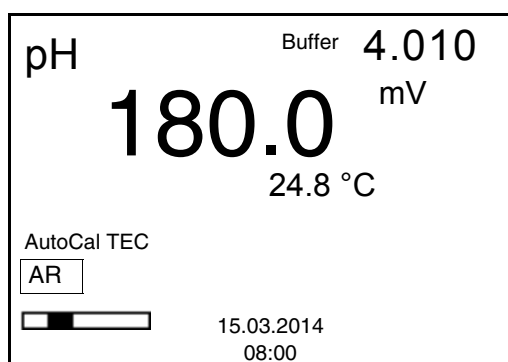

- | | |
|----|--|
| 19 | Wait for the measurement with stability control to be completed or terminate the stability control and take over the calibration value with <ENTER>.
The calibration display for the next buffer appears (voltage display). |
| 20 | If necessary, use <M> to finish calibration or switch to calibration with the next buffer with <ENTER>. |



Note

Calibration is automatically completed after the last buffer of a buffer set has been measured. Then the calibration record is displayed.

The calibration line is determined by linear regression.

4.4.8 Carrying out a manual calibration (ConCal)

Make sure that in the sensor menu, *Buffer* menu, the ConCal buffer set is correctly selected (see page 28).

Use any one to five buffer solutions in ascending or descending order.



Note

If single-point calibration was set in the menu, the calibration procedure is automatically finished with the measurement of buffer solution 1 and the calibration record is displayed.

- 1 In the measured value display, select the measured parameter pH or mV with **<M>**.
- 2 Start the calibration with **<CAL>**.
The calibration display appears.

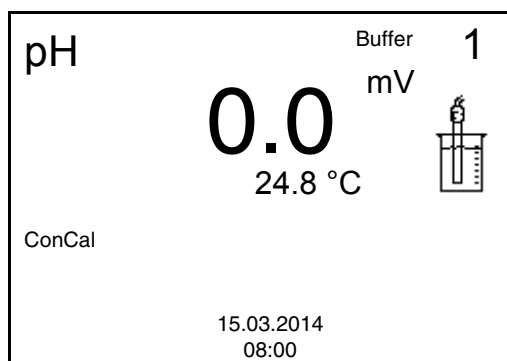

- 3 Thoroughly rinse the electrode with deionized water.
- 4 Immerse the electrode in buffer solution 1.
- 5 When measuring without temperature sensor:
Measure the temperature of the buffer manually and enter it with **<▲><▼>**.
- 6 Start the measurement with **<ENTER>**.
The measured value is checked for stability (stability control).
The [AR] status indicator is displayed. The measured parameter flashes.

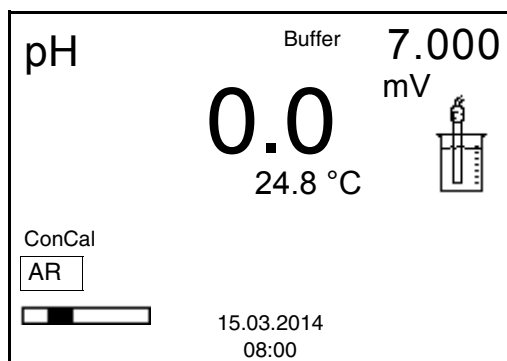

- 7 Wait for the end of the measurement with stability control or accept the calibration value with **<ENTER>**.
The calibration display for the next buffer appears.

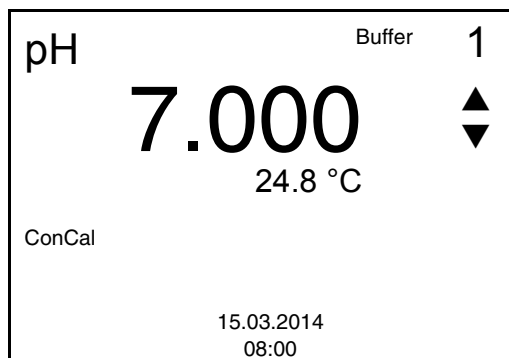

8	Set the nominal buffer value for the measured temperature with <▲><▼> .
9	Accept the calibration value with <ENTER> . The calibration display for the next buffer appears (voltage display).
10	If necessary, finish the calibration procedure as a single-point calibration with <M> . The calibration record is displayed.

**Note**

For **single-point calibration**, the instrument uses the Nernst slope (-59.2 mV/pH at 25 °C) and determines the zero point of the electrode.

Continuing with two-point calibration

11	Thoroughly rinse the electrode with deionized water.
12	Immerse the electrode in buffer solution 2.
13	When measuring without temperature sensor: Measure the temperature of the buffer manually and enter it with <▲><▼> .
14	Start the measurement with <ENTER> . The measured value is checked for stability (stability control). The [AR] status indicator is displayed. The measured parameter flashes.
15	Wait for the measurement with stability control to be completed or terminate the stability control and take over the calibration value with <ENTER> . The calibration display for the next buffer appears.

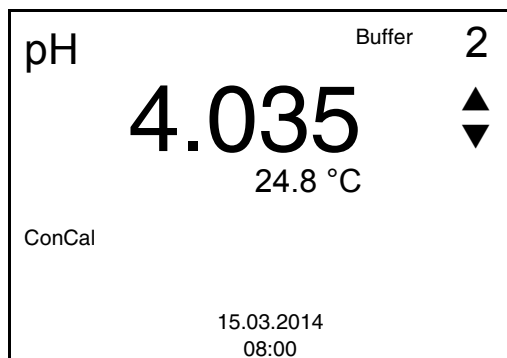

16	Set the nominal buffer value for the measured temperature with <▲><▼> .
17	Accept the calibration value with <ENTER> . The calibration display for the next buffer appears (voltage display).
18	Finish the calibration procedure as a two-point calibration with <M> . The calibration record is displayed.
19	Thoroughly rinse the electrode with deionized water.
20	Immerse the electrode in the next buffer solution.
21	When measuring without temperature sensor: Measure the temperature of the buffer manually and enter it with <▲><▼> .
22	Start the measurement with <ENTER> . The measured value is checked for stability (stability control). The [AR] status indicator is displayed. The measured parameter flashes.
23	Wait for the measurement with stability control to be completed or terminate the stability control and take over the calibration value with <ENTER> . The calibration display for the next buffer appears.

Continuing with three- to five-point calibration

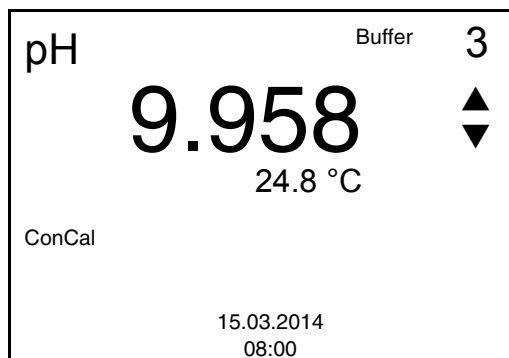

24	Set the nominal buffer value for the measured temperature with <▲><▼> .
25	Accept the calibration value with <ENTER> . The calibration display for the next buffer appears (voltage display).
26	Use <M> to finish calibration or switch to calibration with the next buffer with <ENTER> .



Note

After the fifth buffer has been measured the calibration is automatically finished. Then the calibration record is displayed.

The calibration line is determined by linear regression.

4.4.9 Displaying calibration records

The calibration data can be displayed and then output to the interface

The calibration record of the last calibration is to be found under the menu item, *Calibration / Calibration record*. To open it in the measured value display, press the **<CAL__>** key.

The calibration records of the last calibration procedures are available in the **<F1>/[Menu] / Calibration / Calibration data storage** and **<F1__>/[Menu] / Storage & config/Data storage / Calibration data storage** menu.

Displaying the calibration record

Menu item	Setting/ function	Explanation
<i>Calibration / Calibration data stor- age / Display</i> or <i>Data storage / Calibration data stor- age / Display</i>	-	Displays the calibration record. Further options: <ul style="list-style-type: none"> ● Scroll through the calibration records with <▲><▼>. ● Output the displayed calibration record to the interface with <F2>/[USB output]. ● Quit the display with <F1>/[Back] or <ENTER>. ● Switch directly to the measured value display with <M>.
<i>Calibration / Calibration data stor- age / Output to USB</i> or <i>Data storage / Calibration data stor- age / Output to USB</i>	-	Outputs the calibration records to the interface.

Example

```

30.03.2014 15:55
pH 3310
Ser. no. 08502113

CALIBRATION pH

AutoCal TEC
Buffer 1          4.01
Buffer 2          7.00
Buffer 3          10.01
Voltage 1         184.0 mV
Voltage 2         3.0 mV
Voltage 3         -177.0 mV
Temperatur 1     24.0 øC
Temperatur 2     24.0 øC
Temperatur 3     24.0 øC
Slope            -60.2 mV/pH
Asymmetry        4.0 mV
Sensor           +++

etc...

```

4.4.10 Continuous measurement control (CMC function)

The Continuous Measurement Control (CMC function) facilitates to evaluate the current measured value instantly and definitely.

After each successful calibration the scale of the pH measuring range is displayed in the measured value display. Here you can very clearly see whether or not the current measured value is in the calibrated part of the measuring range.

The following information is displayed:

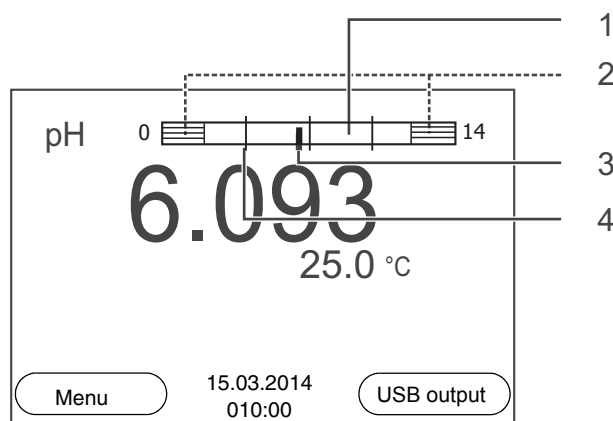

1	Measuring range for which a valid calibration is available (white). Measured values in this range are suitable for documentation.
2	Measuring range for which no valid calibration is available (shaded). Measured values in this range are not suitable for documentation. If necessary, calibrate the meter with buffers covering this measuring range. If the current measured value is outside the calibrated range, this area is shaded stronger. If a measured value is outside the measuring range pH 0 - 14, overflow arrows are displayed at the left or right edge of the measuring range.
3	Currently measured pH value (needle)
4	Marking lines for all nominal buffer values used with the last valid calibration

The limits of the calibrated range are determined by the buffers used for calibration:

Lower limit:	Buffer with lowest pH value - 2 pH units
Upper limit:	Buffer with highest pH value + 2 pH units

4.5 Data memory

You can transmit measured values (datasets) to the data memory:

- Manual storage (see section 4.5.1)
- Automatic storage at intervals (see section 4.5.2)

Each data storage process transmits the current dataset to the interface at the same time.

Measurement dataset

A complete dataset consists of:

- ID number
- Date/time
- Measured value of the connected sensor
- Measured temperature value of the connected sensor or manually set temperature
- AutoRead info: *AR* appears with the measured value if the AutoRead criterion was met while storing (stable measured value). Otherwise, the *AR* display is missing.
- Calibration evaluation: +++, ++, +, -, or no evaluation

Storage locations

The pH 3310 meter has two measurement data memories. The measured values recorded either manually or automatic are stored separately in individual measurement data memories.

Data memory	Maximum number of datasets
<i>Manual data storage</i>	500
<i>Automatic data storage</i>	5000

4.5.1 Manual storage

You can store a measurement dataset to the data memory as follows. The dataset is at the same time output to the interface:

- 1 Press the <STO> key shortly.
The menu for manual data storage appears.

Manual data storage 4 From 500

15.03.2014 11:24:16
pH 7.000 24.8 °C AR +++

ID number: 1

Continue

Back 15.03.2014
08:00

- 2 If necessary, change and confirm the ID number (1 ... 10000) with **<▲>****<▼>** and **<ENTER>**. The dataset is stored. The meter switches to the measured value display.

If the memory is full

The following window appears if all 500 storage locations are occupied:

Warning

Data storage full. Erase?

Yes

No

Back 15.03.2014
08:00

You have the following options:

- To erase the entire storage, confirm *Yes*.
- To cancel the storage process and switch to the measured value display, confirm *No*. Then you can e.g. store the data from the memory to a PC (see section 4.5.3) and subsequently erase the memory (see section 4.5.4).

4.5.2 Automatic storage at intervals

The storage interval (*Interval*) determines the time interval between automatic data storage processes. Each data storage process trans-

mits the current dataset to the interface at the same time.

Configuring the automatic storage function

- 1 Press the <STO __> key.
The menu for automatic data storage appears.

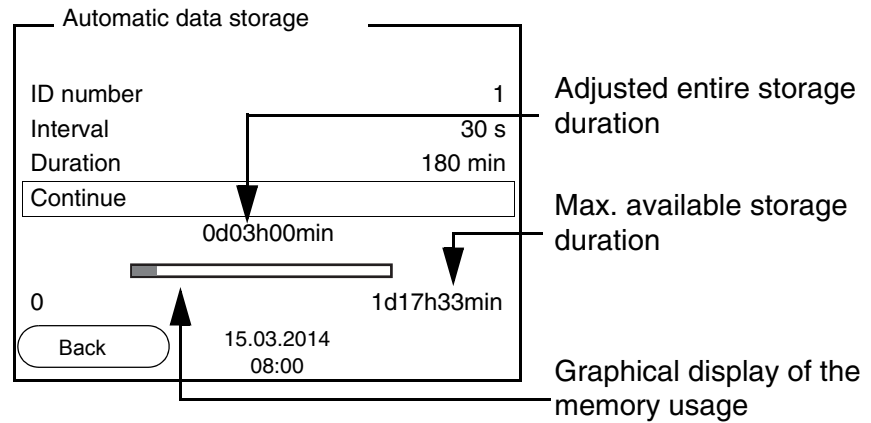

Settings

You can configure the automatic data storage function with the following settings:

Menu item	Possible setting	Explanation
ID number	1 ... 10000	ID number for the dataset series.
<i>Interval</i>	1 s, 5 s, 10 s, 30 s, 1 min, 5 min, 10 min, 15 min, 30 min, 60 min	Storage interval. The lower limit of the storage interval can be restricted by the number of free storage locations. The upper limit is restricted by the storage duration.
<i>Duration</i>	1 min ... x min	Storing duration. Specifies after which time the automatic data storage should be terminated. The lower limit of the storage duration is restricted by the storage interval. The upper limit is restricted by the number of free storage locations.

Starting the automatic storage function

To start the automatic storage function, select *Continue* with $\langle \blacktriangle \rangle \langle \blacktriangledown \rangle$ and confirm with $\langle \text{ENTER} \rangle$. The meter switches to the measured value display.

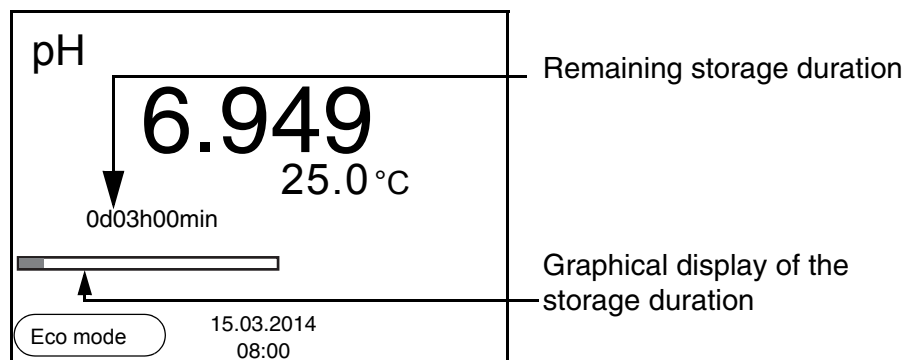

The active automatic data storage function can be recognized by the progress bar in the status line. The progress bar indicates the remaining storage duration.



Note

If the automatic storage function is activated, only the following keys are active: Softkeys, $\langle M \rangle$, $\langle \text{STO} _ _ \rangle$ and $\langle \text{On/Off} \rangle$. The other keys and the automatic switch-off function are deactivated.

Energy saving mode ([Eco mode])

If the automatic storing function is active, the meter provides an energy saving mode ([Eco mode]) to avoid unnecessary energy consumption. The energy saving mode switches off functions of the meter that are not required for the automatic storage of measurement data (such as the display). By pressing any key the energy saving mode is switched off again.

Terminating the automatic storage function prematurely

Proceed as follows to switch off the automatic data storage function before the adjusted storage duration has expired:

- 1 Press the $\langle \text{STO} _ _ \rangle$ key.
The following window appears.

Warning

Stop automatic storage?

Yes

No

Back 15.03.2014
08:00

- 2 Using <▲><▼>, select *Yes* and confirm with <ENTER>. The meter switches to the measured value display. The automatic data storage function is terminated.

4.5.3 Editing the measurement data memory

The contents of the manual or automatic measurement data memory can be shown on the display.

Each of the measurement data memories has a function to erase the entire contents.

The contents of the manual or automatic measurement data memory can be shown on the display and output to the interface.

Each of the measurement data memories has a function to erase the entire contents.

Editing the data memory

The memory is edited in the menu, *Storage & config/ Data storage*. To open the *Storage & config* menu, press the <F1__>/[Menu] key in the measured value display.

Open the manual or automatic storage directly with the <RCL> or <RCL__> key.



Note

The settings are explained here using the manual data memory as an example. The same settings and functions are available for the automatic data memory.

Settings	Menu item	Setting/ function	Explanation
	<i>Data storage / Manual data storage / Display</i>	-	Displays all measurement datasets page by page. Further options: <ul style="list-style-type: none"> ● Scroll through the datasets with <▲><▼>. ● Output the displayed dataset to the interface with <F2>/[USB output]. ● Quit the display with <F1>/[Back].
	<i>Data storage / Manual data storage / Erase</i>	-	Erases the entire manual measurement data memory. Note: All calibration data remain stored when this action is performed.
	<i>Data storage / Manual data storage / Output to USB</i>	-	Outputs all stored measurement data to the interface.

Display presentation of a dataset

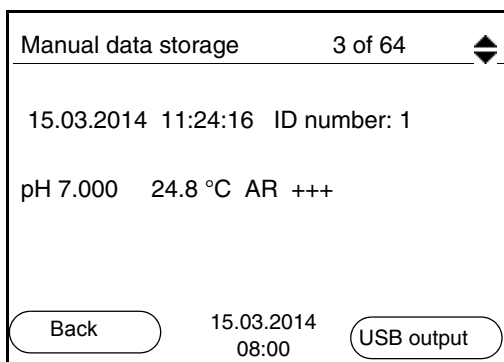

Example

```
30.03.2014 09:56:20
pH 3310
Ser. no. 08502113

ID number 2
pH 6.012 24.8 °C, AR, +++
_____

30.03.2014 10:56:20
pH 3310
Ser. no. 08502113

ID number 2
pH 6.012 24.8 °C, AR, +++
_____
```

Quitting the display

To quit the display of stored measurement datasets, you have the following options:

- Switch directly to the measured value display with **<M>**.
- Quit the display and move to the next higher menu level with **<F1>/[Back]**.

4.5.4 Erasing the measurement data memory

How to erase the measurement data memory is described in section 4.5.3 EDITING THE MEASUREMENT DATA MEMORY.

4.6 Transmitting data (USB interface)

4.6.1 Options for data transmission

Via the USB interface you can transmit data to a PC. The following table shows which data are transmitted to the interface in which way:

Data	Control	Operation / description
Current measured values of all connected sensors	Manual	<ul style="list-style-type: none"> ● With <F2>/[USB output]. ● Simultaneously with every manual storage process (see section 4.5.1).
	Automatic, at intervals	<ul style="list-style-type: none"> ● With <F2__>/[USB output]. Then you can set the transmission interval. <p>Note: For operation with MultiLab pilot: set the <i>Send ID</i> option to <i>No</i> (see section 4.7).</p> <ul style="list-style-type: none"> ● Simultaneously with every automatic storage process (see section 4.5.2).
Stored measured values	Manual	<ul style="list-style-type: none"> ● Displayed dataset with <F2>/[USB output] after calling up from the memory. ● All datasets with the <i>Output to USB</i> function. <p>For details, see section 4.5.3.</p>
Calibration records	Manual	<ul style="list-style-type: none"> ● Calibration record with <F2>/[USB output]. <p>For details, see section 4.6.</p>
	Automatic	<ul style="list-style-type: none"> ● At the end of a calibration procedure.



Note

The following rule applies: With the exception of the menus, shortly pressing the **<F2>/[USB output]** key generally outputs the display contents to the interface (displayed measured values, measurement datasets, calibration records).

4.6.2 Connecting a PC

Connect the pH 3310 to the PC via the USB interface.



Attention

The USB interface is not galvanically isolated.

When a grounded PC is connected, measurements cannot be performed in grounded media as incorrect values would result.

Installation of the USB driver on the PC

System requirements of the PC for installation of the USB driver:

- PC with USB port and CD-ROM drive
- Microsoft Windows
(for details, see enclosed installation CD, Driver directory)

1	Insert the supplied installation CD in the CD drive of your PC.
2	Install the driver from the CD. Follow the Windows installation instructions as necessary.
3	Connect the pH 3310 to the PC via the USB interface. The meter is listed as a virtual COM interface among the connections in the Windows instrument manager.

4.7 MultiLab Importer

With the aid of the MultiLab Importer software, you can record and evaluate measurement data with a PC.



More detailed information can be found in the MultiLab Importer operating manual.

4.8 Reset

You can reset (initialize) all sensor settings and sensor-independent settings separately from each other.

4.8.1 Resetting the measurement settings



Note

The calibration data are reset to the default settings together with the measuring parameters. Recalibrate after performing a reset.

pH

The following settings for pH measurements are reset to the default settings with the *Reset* function:

Setting	Default settings
<i>Buffer</i>	TEC
<i>Cal. interval</i>	7 d
<i>Unit for slope</i>	mV/pH
Measured parameter	pH
Resolution pH	0.001
Resolution mV	0.1
Asymmetry	0 mV
Slope	-59.2 mV
<i>Man. temperature</i>	25 °C
<i>One point calibration</i>	<i>Off</i>
Stability control	On
Temperature unit	°C

The sensor settings are reset under the *Reset* menu item in the menu for calibration and measurement settings. To open the settings, display the required parameter in the measured value display and press the **<F1>/[Menu]** or **<ENTER>** key.

4.8.2 Resetting the system settings

The following system settings can be reset to the default status:

Setting	Default settings
<i>Language</i>	English
<i>Beep</i>	On
<i>Baud rate</i>	4800 Baud
<i>Output format</i>	ASCII
<i>Contrast</i>	50 %
<i>Illumination</i>	Auto
<i>Switchoff time</i>	1 h

The system settings are reset in the menu, *Storage & config / System / Reset*. To open the *Storage & config* menu, press the <F1 __>/[Menu] key in the measured value display.

5 Maintenance, cleaning, disposal

5.1 Maintenance

The only maintenance activity required is replacing the batteries.



Note

See the relevant operating manuals of the electrodes for instructions on maintenance.

5.1.1 Replacing the batteries

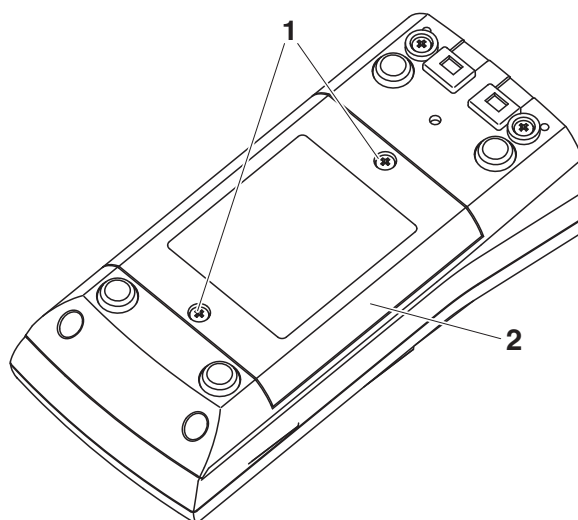

1	Unscrew the screws (1) on the underside of the meter.
2	Open the battery compartment (2) on the underside of the meter.
3	Remove the batteries from the battery compartment.



Caution

Make sure that the poles of the batteries are positioned correctly. The \pm signs on the batteries must correspond to the \pm signs in the battery compartment.



Note

Alternatively, you can also use Ni-MH rechargeable batteries (type Mignon AA). In order to charge the batteries, an external charging device is required.

4	Place four batteries (type Mignon AA) in the battery compartment.
5	Close the battery compartment.

5.2 Cleaning

Occasionally wipe the outside of the measuring instrument with a damp, lint-free cloth. Disinfect the housing with isopropanol as required.



Caution

The housing is made of synthetic material (ABS). Thus, avoid contact with acetone or similar detergents that contain solvents. Remove any splashes immediately.

5.3 Packing

This meter is sent out in a protective transport packing. We recommend: Keep the packing material. The original packing protects the meter against damage during transport.

5.4 Disposal



Note

This meter contains batteries. Batteries that have been removed may only be disposed of at a recycling facility set up for this purpose or via the retail outlet.
It is illegal to dispose of it in household refuse.

6 What to do if...

Error message *OFL, UFL*

Cause	Remedy
pH electrode:	
– Measured value outside the measuring range	– Use suitable electrode
– Air bubble in front of the junction	– Remove air bubble
– Air in the junction	– Extract air or moisten junction
– Cable broken	– Replace the electrode
– Gel electrolyte dried out	– Replace the electrode

Error message, *Error*

Cause	Remedy
pH electrode:	
– The values determined for zero point and slope of the electrode are outside the allowed limits.	– Recalibrate
– Junction contaminated	– Clean the junction
– Electrode broken	– Replace the electrode
Buffer solutions:	
– Incorrect buffer solutions	– Change calibration procedure
– Buffer solutions too old	– Use only once. Note the shelf life
– Buffer solutions depleted	– Change solutions

No stable measured value	Cause	Remedy
	pH electrode:	
	– Junction contaminated	– Clean the junction
	– Membrane contaminated	– Clean membrane
	Test sample:	
	– pH value not stable	– Measure with air excluded if necessary
	– Temperature not stable	– Adjust temperature if necessary
	Electrode + test sample:	
	– Conductivity too low	– Use suitable electrode
	– Temperature too high	– Use suitable electrode
	– Organic liquids	– Use suitable electrode
Sensor symbol flashes	Cause	Remedy
	– Calibration interval expired	– Recalibrate the measuring system
Display	Cause	Remedy
	– Batteries almost empty	– Replace the batteries (see section 5.1 MAINTENANCE)

Obviously incorrect measured values	Cause	Remedy
	pH electrode:	
	– pH electrode unsuitable	– Use suitable electrode
	– Temperature difference between buffer and test sample too great	– Adjust temperature of buffer or sample solutions
	– Measurement procedure not suitable	– Follow special procedure
Meter does not react to keystroke	Cause	Remedy
	– Operating condition undefined or EMC load unallowed	– Processor reset: Press the <ENTER> and <On/Off> key simultaneously
You want to know which software version is in the meter	Cause	Remedy
	– E.g., a question by the service department	– Switch on the meter. Open the menu, <F1__> / [Menu] / <i>Storage & config</i> / <i>SystemService information</i> . The instrument data are displayed.

7 Technical data

7.1 General data

Dimensions	ca. 180 x 80 x 55 mm	
Weight	Approx. 0.4 kg	
Mechanical structure	Type of protection	IP 67
Electrical safety	Protective class	III
Test certificates	CE	
Ambient conditions	Storage	- 25 °C ... + 65 °C
	Operation	-10 °C ... + 55 °C
	Admissible relative humidity	Yearly mean: < 75 % 30 days/year: 95 % Other days: 85 %
Power supply	Batteries	4 x 1.5 V alkali-manganese batteries, type AA
	Rechargeable batteries	4 x 1.2 V NiMH rechargeable batteries, type AA (no charging function)
	Operational life	Up to 1000 h without / 150 h with illumination
Sensor input	Input resistance	> 5 * 10 ¹² ohm
	Input current	< 1 * 10 ⁻¹² A
USB interface	Type	USB 1.1 USB B (device), data output
	Baud rate	Adjustable: 1200, 2400, 4800, 9600, 19200 Baud
	Data bits	8
	Stop bits	2
	Parity	None
	Handshake	RTS/CTS
	Cable length	Max. 3 m
Guidelines and norms used	EMC	EC directive 2004/108/EC EN 61326-1 EN 61000-3-2 EN 61000-3-3 FCC Class A
	Meter safety	EC directive 2006/95/EC EN 61010-1
	IP protection class	EN 60529

7.2 Measuring ranges, resolution, accuracy

Measuring ranges, resolution	Variable	Measuring range	Resolution
	pH	- 2.0 ... + 20.0	0.1
		- 2.00 ... + 20.00	0.01
		- 2.000 ... + 19.999	0.001
	U [mV]	- 2500 ... + 2500	1
		- 1200.0 ... + 1200.0	0.1
	T [°C]	- 5.0 ... + 105.0	0.1
T [°F]	23.0 ... + 221.0	0.1	

Manual temperature input	Variable	Range	Increment
	T _{manual} [°C]	- 25 ... + 130	1
	T _{manual} [°F]	-13 ... + 266	1

Accuracy (± 1 digit)	Variable	Accuracy	Temperature of the test sample
	pH / range *		
	- 2.0 ... + 20.0	± 0.1	+ 15 °C ... + 35 °C
	- 2.00 ... + 20.00	± 0.01	+ 15 °C ... + 35 °C
	- 2.000 ... + 19.999	± 0.005	+ 15 °C ... + 35 °C
	U [mV] / range		
	- 2500 ... + 2500	± 1	+ 15 °C ... + 35 °C
	- 1200.0 ... + 1200.	± 0.3	+ 15 °C ... + 35 °C
	T [°C] / temperature sensor		
	NTC 30	± 0.1	
	PT 1000	± 0.1	

* when measuring in a range of ± 2 pH around a calibration point



Note

The accuracy values specified here apply exclusively to the meter. The accuracy of the electrodes and buffer solutions has to be taken into account additionally.

8 Lists

This chapter provides additional information and orientation aids.

Specialist terms The glossary briefly explains the meaning of the specialist terms. However, terms that should already be familiar to the target group are not described here.

Index The index will help you to find the topics that you are looking for.

Glossary

Adjusting To manipulate a measuring system so that the relevant value (e.g. the displayed value) differs as little as possible from the correct value or a value that is regarded as correct, or that the difference remains within the tolerance.

Asymmetry see zero point

AutoRange Name of the automatic selection of the measuring range.

Calibration Comparing the value from a measuring system (e.g. the displayed value) to the correct value or a value that is regarded as correct. Often, this expression is also used when the measuring system is adjusted at the same time (see adjusting).

Electromotive force of an electrode

The electromotive force U of the combination electrode is the measurable electromotive force of an electrode in a solution. It equals the sum of all the galvanic voltages of the combination electrode. Its dependency on the pH results in the electrode function, which is characterized by the parameters, slope and zero point.

Junction

The junction is a porous body in the housing wall of reference electrodes or electrolyte bridges. It arranges the electrical contact between two solutions and makes the electrolyte exchange more difficult. The expression, junction, is also used for ground or junctionless transitions.

Measured parameter

The measured parameter is the physical dimension determined by measuring, e.g. pH, conductivity or D.O. concentration.

Measured value

The measured value is the special value of a measured parameter to be determined. It is given as a combination of the numerical value and unit (e. g. 3 m; 0.5 s; 5.2 A; 373.15 K).

ORP	The ORP is caused by oxidizing or reducing substances dissolved in water if these substances become effective on an electrode surface (e.g. a gold or platinum surface).
pH value	The pH value is a measure of the acidic or basic effect of an aqueous solution. It corresponds to the negative decadic logarithm of the molal hydrogen ions activity divided by the unit of the molality. The practical pH value is the value of a pH measurement.
Potentiometry	Name of a measuring technique. The signal (depending on the measured parameter) of the electrode is the electrical potential. The electrical current remains constant.
Reset	Restoring the original condition of all settings of a measuring system.
Resolution	Smallest difference between two measured values that can be displayed by a meter.
Slope	The slope of a linear calibration function.
Stability control (AutoRead)	Function to control the measured value stability.
Standard solution	The standard solution is a solution where the measured value is known by definition. It is used to calibrate a measuring system.
Test sample	Designation of the test sample ready to be measured. Normally, a test sample is made by processing the original sample. The test sample and original sample are identical if the test sample was not processed.
Zero point	The zero point of a pH combination electrode is the pH value at which the electromotive force of the pH combination electrode at a specified temperature is zero. Normally, this is at 25 °C.

Index

A

- Authorized use 10
- Automatic switch-off function 14
- AutoRead
 - pH 25, 27

B

- Battery compartment 12, 56

C

- Calibration
 - pH 30
- Calibration evaluation
 - pH 34
- Calibration interval 35
- Calibration points
 - pH 32
- Calibration records 42
- Connecting a PC 53
- Connectors 8
- Copyright 2

D

- Dataset 45
- Date and time 20
- Default settings
 - Measured parameter 54
 - System settings 55
- Display 7

E

- Energy saving feature 13
- Energy saving mode 48

F

- Firmware update 67

I

- Initial commissioning 12, 13
- Initialize 54
- Interval for calibration 35

K

- Keys 6

M

- Measured value display 16
- Measurement accuracy 35
- Measurement data memory
 - Edit 49
 - Erase 49
 - Storage locations 45
- Measurement dataset 45
- Measuring
 - ORP 26
 - pH 25
- Menu for calibration and measurement settings
 - pH/ORP 28
- Menus (navigation) 16
- Messages 17

O

- Operational safety 10

P

- pH buffer sets 30
- Precautions 9
- Print 52

R

- Reset 54

S

- Safety 9
- Scope of delivery 12
- Setting the date 13
- Setting the time 13
- Single-point calibration
 - pH 37, 40
- Slope
 - pH 30
- Stability control
 - Automatic 23
- Storage interval 46
- Storing in memory 45
 - Automatic 47

Manual 45

T

Temperature measurement

pH 24

Three-point calibration

pH 37, 41

Transmitting data 52

Transmitting measured values 52

Two-point calibration

pH 37, 40

Z

Zero point of pH electrode 30

9 Firmware update

General information

Available firmware updates are provided on the Internet. With the "Firmware Update " program and a PC you can update the firmware of the pH 3310 to the newest version.

For the update you have to connect the meter to a PC.

For the update via the USB interface, the following is required:

- a free USB interface (virtual COM port) on the PC
- the driver for the USB interface (on the enclosed CD-ROM)
- the USB cable (included in the scope of delivery of the pH 3310).

Program installation

- | | |
|---|--|
| 1 | Install the downloaded firmware update on a PC.

An update folder is created in the Windows start menu. If an update folder already exists for the meter (or meter type), the new data is displayed there. |
|---|--|

Program start

- | | |
|---|--|
| 2 | In the windows start menu, open the update folder and start the firmware update program. |
|---|--|

Firmware update

- | | |
|---|--|
| 3 | Using the USB interface cable, connect the pH 3310 to a USB interface (virtual COM port) of the PC. |
| 4 | Switch on the pH 3310. |
| 5 | In the firmware update program, start the update process with OK. |
| 6 | Follow the instructions of the firmware update program. During the programming process, a corresponding message and a progress bar (in %) are displayed. The programming process takes approx. three minutes. A terminatory message is displayed after a successful programming process. The firmware update is completed. |
| 7 | Disconnect the pH 3310 from the PC. The pH 3310 is ready for operation again. |

After switching the meter off and on you can check whether the meter has taken over the new software version (see page 60).

What can Xylem do for you?

We're a global team unified in a common purpose: creating innovative solutions to meet our world's water needs. Developing new technologies that will improve the way water is used, conserved, and re-used in the future is central to our work. We move, treat, analyze, and return water to the environment, and we help people use water efficiently, in their homes, buildings, factories and farms. In more than 150 countries, we have strong, long-standing relationships with customers who know us for our powerful combination of leading product brands and applications expertise, backed by a legacy of innovation.

For more information on how Xylem can help you, go to xylem.com.



Service address:

Xylem Analytics Germany
Sales GmbH & Co. KG
WTW
Dr.-Karl-Slevogt-Str. 1
82362 Weilheim
Germany

Tel.: +49 881 183-325
Fax: +49 881 183-414
E-Mail wtw.rma@xylem.com
Internet: www.WTW.com



Xylem Analytics Germany GmbH
Dr.-Karl-Slevogt-Str. 1
82362 Weilheim
Germany